

# 2EHDRRM-XXPL

PCB Terminal Blocks > PCB Connector-Socket

Date:2026-05-09

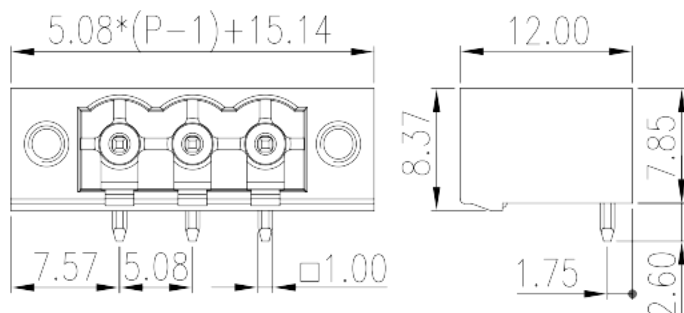
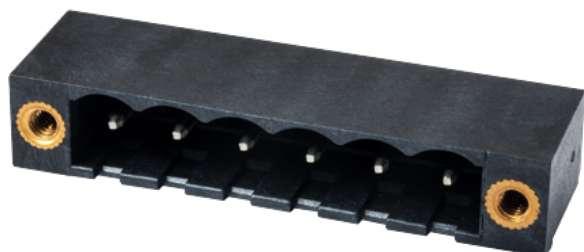

The web catalog is for reference only. Dinkle remains the right of product modification and engineering change of the design. The final product is made according to engineering drawing.

## Product Description

Pitch : 5.08mm, 300V, 15A

## General information

Short description	PCB Connector-Socket, Reflow soldering
Category	PCB Connector-Socket
Pitch (mm)	5.08
Color	Black (default)
Type of locking	With threaded flange
Soldering method	Reflow Soldering (Temperature condition according to standard IPC/JEDEC J-STD-020E)
Length (mm)	$5.08*(P-1)+15.14$
Width (mm)	12
Height (mm)	8.37
Pin demensions (Thickness x Width)(mm)	1.0x1.0
PCB hole diameter (mm)	1.60~1.70
Number of positions	02P~24P
Level	Single level
Connection points	1

## Material information

Insulation material	HIGH-TEMPERATURE PLASTICS
Insulation material group	IIIa
Flame retardant rating , compliant with UL94	V0
Insulation resistance	□500MΩ at DC 500V
Conductor material	COPPER ALLOY
Plating of conductor surface	Tin PLATED
MSL	1

## Connection data-IEC

Rated voltage (V)	630
Rated current (A)	18
Rated voltage (II/2)(V)	400
Rated voltage (III/2) (V)	320
Rated voltage (III/3)(V)	250
Rated impulse voltage (II/2)(KV)	4
Rated impulse voltage (III/2)(KV)	4
Rated impulse voltage (III/3)(KV)	4

## Connection data-UL

Rated voltage (UL/CUL Group B)(V)	300
Rated current (UL/CUL Group B)(A)	15
Rated voltage (UL/CUL Group D)(V)	300
Rated current (UL/CUL Group D)(A)	10

## Environment & Safety

Back of the hand protection (YES or NO)	YES
Finger protection (YES or NO)	YES
Operating temperature. max (°C)	120
Operating temperature. min (°C)	-40

## UL Recognized

Rated voltage (Group B)(V)	300
Rated current (Group B)(A)	15
Rated voltage (Group D)(V)	300

Rated current (Group D)(A)	10
----------------------------	----

### CUL Recognized

Rated voltage (Group B)(V)	300
Rated current (Group B)(A)	15
Rated voltage (Group D)(V)	300
Rated current (Group D)(A)	10

### VDE Approval

Rated voltage (V)	630
Rated current (A)	18

### Drawings

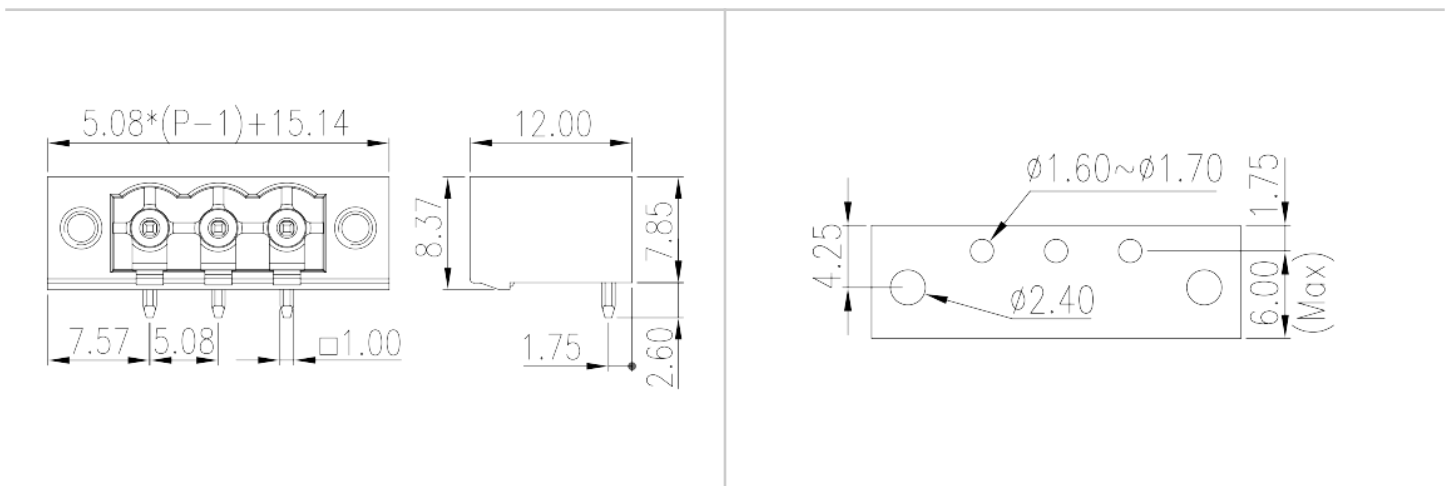

### Approvals

