

# DKU15

NEMA Terminal Blocks > Rail Mounting

Date:2026-07-04

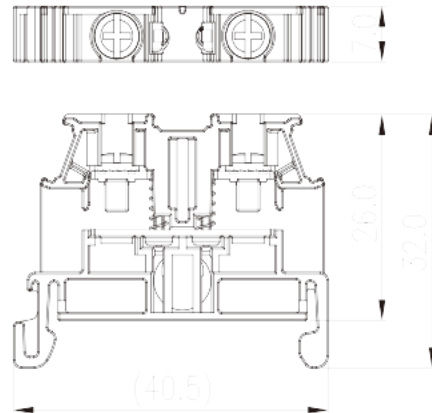
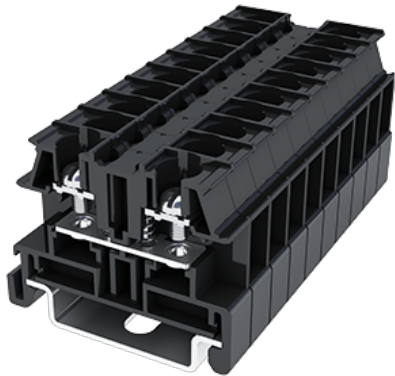

The web catalog is for reference only. Dinkle remains the right of product modification and engineering change of the design. The final product is made according to engineering drawing.

## Product Description

M3, 600V, 15/20A

## General information

Short description	Feed-Through single level, Screw Connection
Category	Feed-Through single level
Pitch (mm)	7
Color	Refer to drawing
Connection method	Screw Connection
Type of locking	Rail mounting
Length (mm)	40.5
Width (mm)	7
Height (mm)	33.5 ( TS-35N ) /41 ( TS-35/15N )
Number of poles	01P
Number of positions	01P
Level	1
Connection points	2

## Material information

Insulation material	PC
---------------------	----

Insulation material group	IIIa
Flame retardant rating , compliant with UL94	V2
Insulation resistance	□1000MΩ at DC 500V
Conductor material	COPPER ALLOY
Plating of conductor surface	Tin PLATED

## Connection data-IEC

Rated voltage (V)	800
Rated current (A)	17.5
Rated voltage (III/3)(V)	800
Rated impulse voltage (III/3)(KV)	8
Conductor cross section solid. min (mm <sup>2</sup> )	0.2
Conductor cross section solid.max (mm <sup>2</sup> )	1.5
Conductor cross section stranded. min (mm <sup>2</sup> )	0.2
Conductor cross section stranded. max (mm <sup>2</sup> )	1.5
Screw thread	M3
Philips screwdriver size	PH2
Rated torque (N.m)	0.6~1
Recommend tightening torque. min (N.m)	0.6
Stripping Length (mm)	The stripping length depends on the specification provided by the cablelug manufacturer.
Mounting rail	TS-35N · TS-35/15N
End cover plate required	YES
Grounding connections	NO

## Connection data-UL

Rated voltage (UL/CUL Group B)(V)	600
Rated current (UL/CUL Group B)(A)	15
Rated voltage (UL/CUL Group C)(V)	600
Rated current (UL/CUL Group C)(A)	15
Rated voltage (UL/CUL Group D)(V)	600
Rated current (UL/CUL Group D)(A)	15
Min. solid wire connection (AWG) acc. to UL/CUL	26
Max. solid wire connection AWG acc. to UL/CUL	14
Min. stranded wire connection AWG acc. to UL/CUL	26

Max. stranded wire connection AWG acc. to UL/CUL	14
--	----

## Environment & Safety

Back of the hand protection (YES or NO)	YES
Finger protection (YES or NO)	YES
Operating temperature. max (°C)	125
Operating temperature. min (°C)	-40

## UL Recognized

Wire Range (Group B)(AWG)	26-14/(2)26-(2)16
Rated voltage (Group B)(V)	600
Rated current (Group B)(A)	15/20
Wire Range (Group C)(AWG)	26-14/(2)26-(2)16
Rated voltage (Group C)(V)	600
Rated current (Group C)(A)	15/20
Wire Range (Group D)(AWG)	26-14/(2)26-(2)16
Rated voltage (Group D)(V)	600
Rated current (Group D)(A)	5

## CUL Recognized

Wire Range (Group B)(AWG)	26-14/(2)26-(2)16
Rated voltage (Group B)(V)	600
Rated current (Group B)(A)	15/20
Wire Range (Group C)(AWG)	26-14/(2)26-(2)16
Rated voltage (Group C)(V)	600
Rated current (Group C)(A)	15/20
Wire Range (Group D)(AWG)	26-14/(2)26-(2)16
Rated voltage (Group D)(V)	600
Rated current (Group D)(A)	5

## VDE Approval

Wire Range (mm <sup>2</sup> )	0.2~1.5
Rated voltage (V)	800
Rated current (A)	17.5

## Drawings

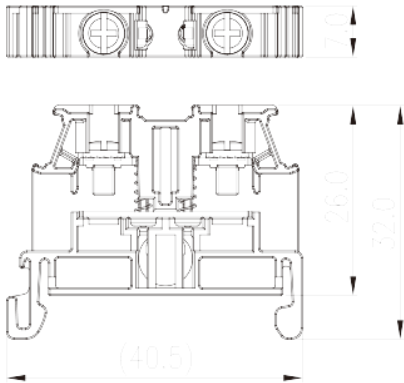

## Approvals

