

0229-F5XX

PCB Terminal Blocks > PCB Connector-Plug

Date:2026-07-04

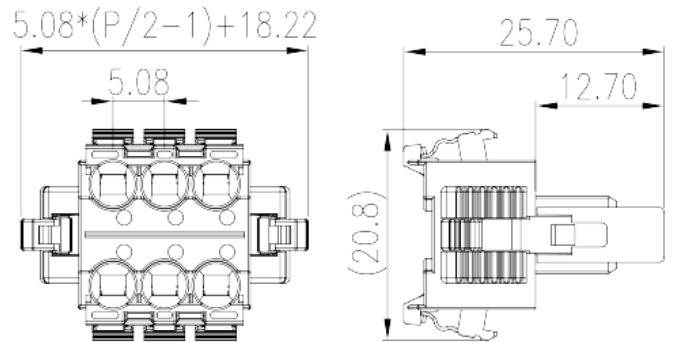

The web catalog is for reference only. Dinkle remains the right of product modification and engineering change of the design. The final product is made according to engineering drawing.

Product Description

Pitch : 5.08 mm, 300V, 12A

General information

Short description	PCB Connector-Plug, Push-in Design
Category	PCB Connector – Plug
Pitch (mm)	5.08
Color	Black (default)
Connection method	Push in Design
Type of locking	With lock flange
Length (mm)	$5.08*(P/2-1)+18.16$
Width (mm)	20.8
Height (mm)	25.7
Number of positions	04P~40P
Level	2

Material information

Insulation material	PA
Insulation material group	I
Flame retardant rating , compliant with UL94	V0

Insulation resistance	≥500MΩ at DC 500V
Conductor material	HIGH PERFORMANCE COPPER ALLOY
Plating of conductor surface	Tin PLATED

Connection data-IEC

Rated voltage (V)	320
Rated current (A)	14
Rated voltage (II/2)(V)	320
Rated voltage (III/2) (V)	160
Rated voltage (III/3)(V)	160
Rated impulse voltage (II/2)(KV)	2.5
Rated impulse voltage (III/2)(KV)	2.5
Rated impulse voltage (III/3)(KV)	2.5
Conductor cross section solid. min (mm ²)	0.2
Conductor cross section solid.max (mm ²)	1.5
Conductor cross section stranded. min (mm ²)	0.2
Conductor cross section stranded. max (mm ²)	1.5
Conductor cross section flexible, with min ferrule without plastic sleeve (mm ²)	0.25
Conductor cross section flexible, with max ferrule without plastic sleeve (mm ²)	1.5
Conductor cross section flexible, with min ferrule with plastic sleeve (mm ²)	0.25
Conductor cross section flexible, with max ferrule with plastic sleeve (mm ²)	1.5
Slotted screwdriver size (Blade thickness x Width)(mm)	0.6x3.5
Stripping Length (mm)	8~9

Connection data-UL

Rated voltage (UL/CUL Group B)(V)	300
Rated current (UL/CUL Group B)(A)	12
Rated voltage (UL/CUL Group D)(V)	300
Rated current (UL/CUL Group D)(A)	10
Min. solid wire connection (AWG) acc. to UL/CUL	28
Max. solid wire connection AWG acc. to UL/CUL	14
Min. stranded wire connection AWG acc. to UL/CUL	28
Max. stranded wire connection AWG acc. to UL/CUL	14

Environment & Safety

Back of the hand protection (YES or NO)	YES
Finger protection (YES or NO)	YES
Operating temperature. max (°C)	120
Operating temperature. min (°C)	-40

UL Recognized

Wire Range (Group B)(AWG)	28~14
Rated voltage (Group B)(V)	300
Rated current (Group B)(A)	12
Wire Range (Group D)(AWG)	28~14
Rated voltage (Group D)(V)	300
Rated current (Group D)(A)	10

CUL Recognized

Wire Range (Group B)(AWG)	28~14
Rated voltage (Group B)(V)	300
Rated current (Group B)(A)	12
Wire Ranget (Group D)(AWG)	28~14
Rated voltage (Group D)(V)	300
Rated current (Group D)(A)	10

Drawings

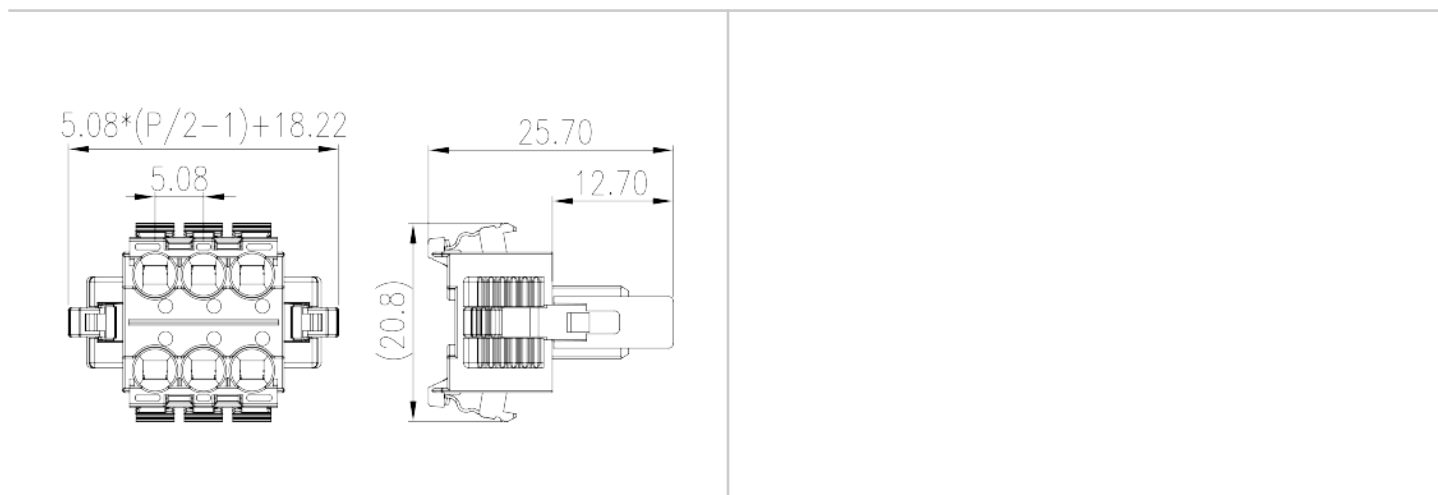

Approvals

