

# DKM50-U

DIN Rail Terminal Blocks > Stud Connection

Date:2026-07-04

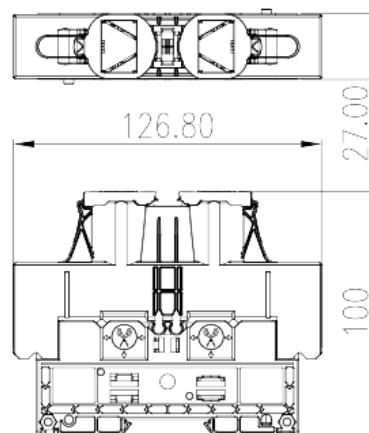

The web catalog is for reference only. Dinkle remains the right of product modification and engineering change of the design. The final product is made according to engineering drawing.

## Product Description

M8, 1500V, 200A, Beige (default)

## General information

Short description	Feed-through Single Level, Stud Connection
Category	Feed-through Single Level
Pitch (mm)	27
Color	Refer to drawing
Connection method	Stud Connection
Length (mm)	126.8
Width (mm)	27
Height (mm)	100
Level	Single level
Connection points	2

## Material information

Insulation material	PA
Insulation material group	I
Flame retardant rating , compliant with UL94	V0
Insulation resistance	□500MΩ at DC 500V

## Connection data-IEC

Rated voltage (V)	1500
Rated current (A)	150
Rated voltage (III/3)(V)	1500
Rated impulse voltage (III/3)(KV)	8
Conductor cross section solid. min (mm <sup>2</sup> )	2.5
Conductor cross section solid.max (mm <sup>2</sup> )	50
Conductor cross section stranded. min (mm <sup>2</sup> )	2.5
Conductor cross section stranded. max (mm <sup>2</sup> )	50
Screw thread	M8
Philips screwdriver size	13X6.3
Recommend tightening torque. min (N.m)	6
Recommend tightening torque. max (N.m)	12
Stripping Length (mm)	The stripping length depends on the specification provided by the cable lug manufacturer
Mounting rail	TS-35
End cover plate required	NO
Grounding connections	NO

## Connection data-UL

Rated voltage (UL/CUL Group E)(V)	1500
Rated current (UL/CUL Group E)(A)	*Single-Cable 150A / Double-Cable 200A
Min. solid wire connection (AWG) acc. to UL/CUL	14
Max. solid wire connection AWG acc. to UL/CUL	1/0
Min. stranded wire connection AWG acc. to UL/CUL	14
Max. stranded wire connection AWG acc. to UL/CUL	1/0

## Environment & Safety

Back of the hand protection (YES or NO)	YES
Finger protection (YES or NO)	NO
Operating temperature. max (°C)	120
Operating temperature. min (°C)	-40

## UL Recognized

Wire Range (Group E)(AWG)	14~1/0
---------------------------	--------

Rated voltage (Group E)(V)	1500
Rated current (Group E)(A)	*Single-Cable 150A / Double-Cable 200A

**CUL Recognized**

Wire Range (Group E)(AWG)	14~1/0
Rated voltage (Group E)(V)	1500
Rated current (Group E)(A)	*Single-Cable 150A / Double-Cable 200A

**Drawings**

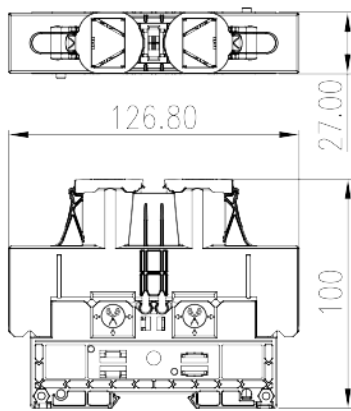

**Approvals**

