

# PMM2.5WSH

NEMA Terminal Blocks &gt; Panel Mounting

Date:2026-05-09Version:1.1

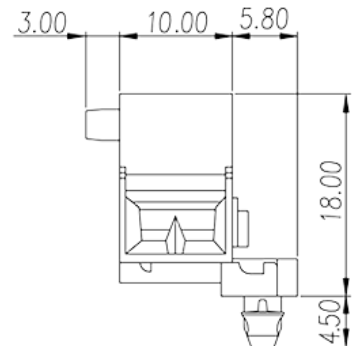
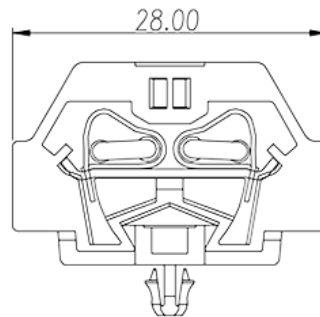
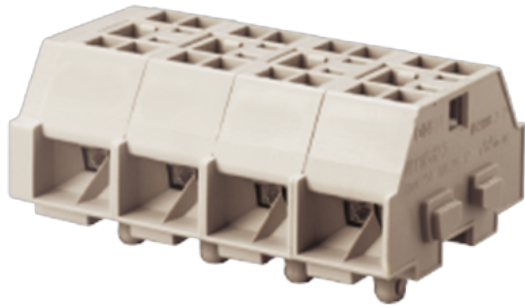

The web catalog is for reference only. Dinkle remains the right of product modification and engineering change of the design. The final product is made according to engineering drawing.

## Product Description

600V, 25A, Beige (default)

## General information

Short description	DIN Rail terminal blocks, Panel mounting terminal blocks
Category	Panel mounting terminal blocks
Color	Beige (default)
Connection method	Spring Clamp Connection
Type of locking	Panel Mounting
Length (mm)	10
Width (mm)	22.5
Height (mm)	28
Number of positions	01P~16P
Level	Single level
Connection points	4

## Material information

Insulation material	PA
Insulation material group	I

Flame retardant rating , compliant with UL94

V0

## Connection data-IEC

Rated voltage (V)	630
Rated current (A)	24
Rated voltage (III/3)(V)	630
Rated impulse voltage (II/2)(KV)	8
Rated impulse voltage (III/2)(KV)	8
Rated impulse voltage (III/3)(KV)	8
Conductor cross section solid. min (mm <sup>2</sup> )	0.5
Conductor cross section solid.max (mm <sup>2</sup> )	2.5
Conductor cross section stranded. min (mm <sup>2</sup> )	0.5
Conductor cross section stranded. max (mm <sup>2</sup> )	2.5
Slotted screwdriver size (Blade thickness x Width)(mm)	0.4x2.5
Stripping Length (mm)	8~10
End cover plate required	YES
Grounding connections	NO

## Connection data-UL

Rated voltage (UL/CUL Group B)(V)	600
Rated current (UL/CUL Group B)(A)	25
Rated voltage (UL/CUL Group C)(V)	600
Rated current (UL/CUL Group C)(A)	25
Rated voltage (UL/CUL Group D)(V)	600
Rated current (UL/CUL Group D)(A)	25
Min. solid wire connection (AWG) acc. to UL/CUL	28
Max. solid wire connection AWG acc. to UL/CUL	12
Min. stranded wire connection AWG acc. to UL/CUL	14
Max. stranded wire connection AWG acc. to UL/CUL	12

## Environment & Safety

Back of the hand protection (YES or NO)	YES
Finger protection (YES or NO)	YES
Operating temperature. max (°C)	120
Operating temperature. min (°C)	-40

## UL Recognized

Wire Range (Group B)(AWG)	28~12
Rated voltage (Group B)(V)	600
Rated current (Group B)(A)	25
Wire Range (Group C)(AWG)	28~12
Rated voltage (Group C)(V)	600
Rated current (Group C)(A)	25
Wire Range (Group D)(AWG)	28~12
Rated voltage (Group D)(V)	600
Rated current (Group D)(A)	25

## CUL Recognized

Wire Range (Group B)(AWG)	28~12
Rated voltage (Group B)(V)	600
Rated current (Group B)(A)	25
Wire Range (Group C)(AWG)	28~12
Rated voltage (Group C)(V)	600
Rated current (Group C)(A)	25
Wire Ranget (Group D)(AWG)	28~12
Rated voltage (Group D)(V)	600
Rated current (Group D)(A)	25

## Drawings

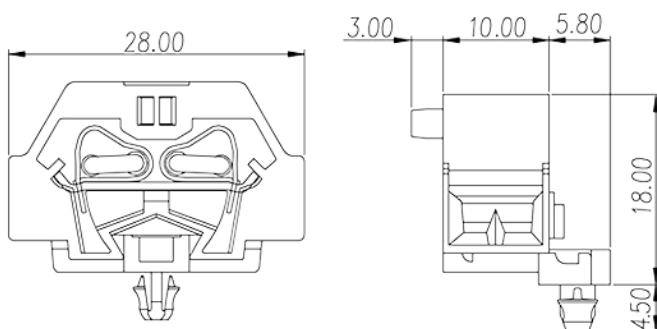

## Approvals

