

P-8A0

Barrier Terminal Blocks > Wire Terminal

Date:2026-05-09

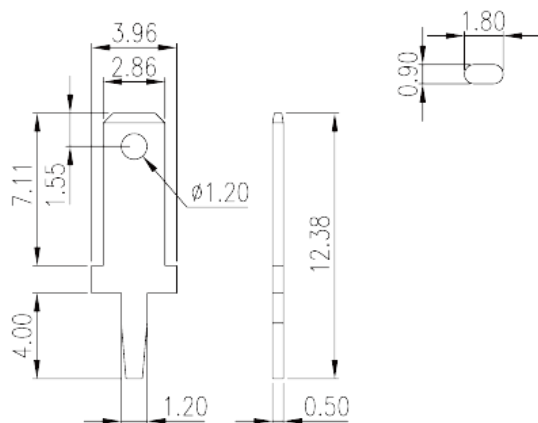

The web catalog is for reference only. Dinkle remains the right of product modification and engineering change of the design.
The final product is made according to engineering drawing.

Product Description

0.5x1.2mm

General information

Short description	Barrier terminal blocks, Quick terminal blocks
Category	Quick terminal blocks
Pin demensions (Thickness x Width)(mm)	0.5x1.2

Material information

Conductor material	COPPER ALLOY
Plating of conductor surface	Tin PLATED

Drawings

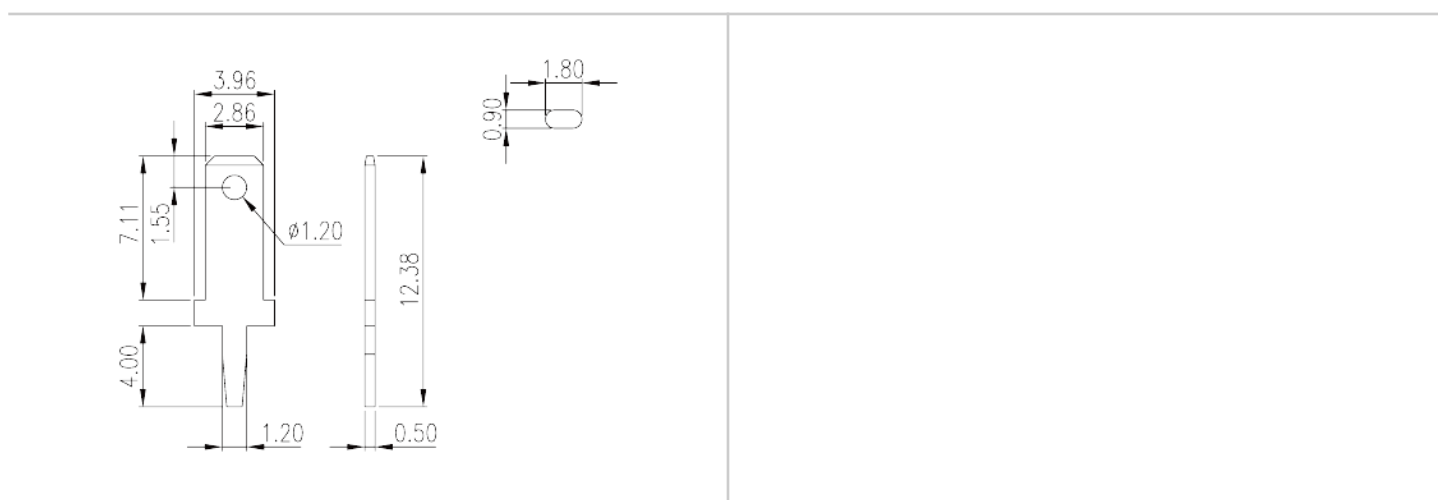

Approvals

