

# 0191-04XXC

PCB Terminal Blocks > PCB Connector-Plug

Date:2026-07-05

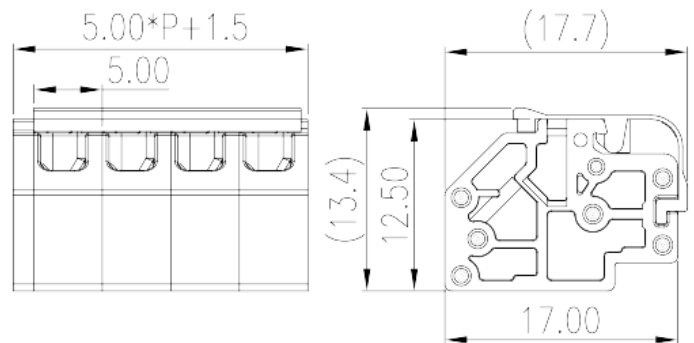
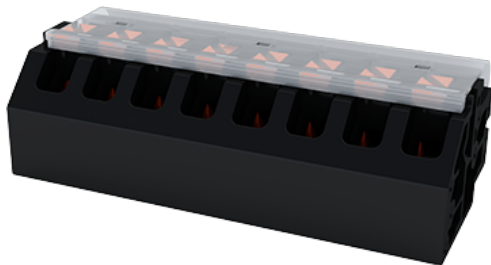

The web catalog is for reference only. Dinkle remains the right of product modification and engineering change of the design. The final product is made according to engineering drawing.

## Product Description

Pitch :5.0mm, 300V, 5A

## General information

Short description	PCB Connector-Plug, Push-in Design
Category	PCB Connector – Plug
Pitch (mm)	5.00
Color	Black (default)
Connection method	Push in Design
Type of locking	Without
Length (mm)	5.00*P+1.5
Width (mm)	17.7
Height (mm)	13.4
Number of positions	02P~20P
Level	Single level

## Material information

Insulation material	PA
Insulation material group	I
Flame retardant rating , compliant with UL94	V0

Insulation resistance	≥500MΩ at DC 500V
Conductor material	COPPER ALLOY
Plating of conductor surface	Tin PLATED

## Connection data-IEC

Rated voltage (V)	630
Rated current (A)	5
Rated voltage (II/2)(V)	630
Rated voltage (III/2) (V)	320
Rated voltage (III/3)(V)	250
Rated impulse voltage (II/2)(KV)	4
Rated impulse voltage (III/2)(KV)	4
Rated impulse voltage (III/3)(KV)	4
Conductor cross section solid. min (mm <sup>2</sup> )	0.5
Conductor cross section solid.max (mm <sup>2</sup> )	1.5
Conductor cross section stranded. min (mm <sup>2</sup> )	0.5
Conductor cross section stranded. max (mm <sup>2</sup> )	1.5
Conductor cross section flexible, with min ferrule without plastic sleeve (mm <sup>2</sup> )	0.5
Conductor cross section flexible, with max ferrule without plastic sleeve (mm <sup>2</sup> )	1
Conductor cross section flexible, with min ferrule with plastic sleeve (mm <sup>2</sup> )	0.5
Conductor cross section flexible, with max ferrule with plastic sleeve (mm <sup>2</sup> )	1
Slotted screwdriver size (Blade thickness x Width)(mm)	0.4x2.5
Stripping Length (mm)	8~9

## Connection data-UL

Rated voltage (UL/CUL Group B)(V)	300
Rated current (UL/CUL Group B)(A)	5
Rated voltage (UL/CUL Group D)(V)	300
Rated current (UL/CUL Group D)(A)	5
Min. solid wire connection (AWG) acc. to UL/CUL	24
Max. solid wire connection AWG acc. to UL/CUL	16
Min. stranded wire connection AWG acc. to UL/CUL	24
Max. stranded wire connection AWG acc. to UL/CUL	16

## Environment & Safety

Finger protection (YES or NO)	YES
Operating temperature. max (°C)	120
Operating temperature. min (°C)	-40

## UL Recognized

Wire Range (Group B)(AWG)	24~16
Rated voltage (Group B)(V)	300
Rated current (Group B)(A)	5
Wire Range (Group D)(AWG)	24~16
Rated voltage (Group D)(V)	300
Rated current (Group D)(A)	5

## CUL Recognized

Wire Range (Group B)(AWG)	24~16
Rated voltage (Group B)(V)	300
Rated current (Group B)(A)	5
Wire Ranget (Group D)(AWG)	24~16
Rated voltage (Group D)(V)	300
Rated current (Group D)(A)	5

## Drawings

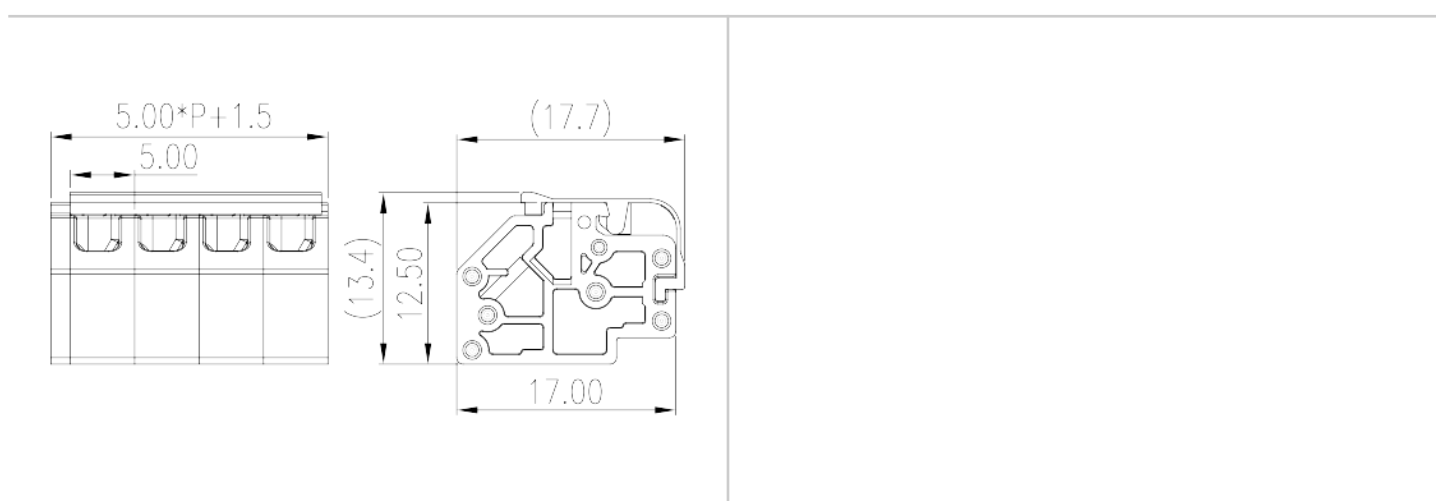

## Approvals

