

# DP2.5NU-TR-TFLXX

DIN Rail Terminal Blocks > Push-in Design

Date:2026-05-09

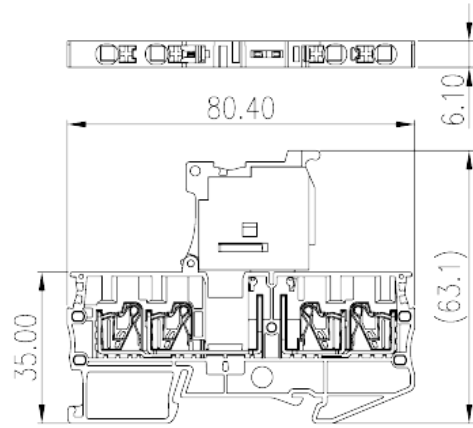
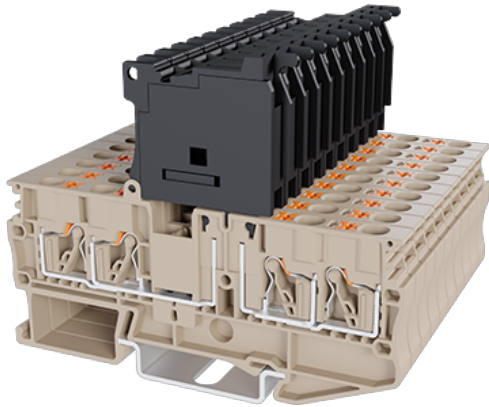

The web catalog is for reference only. Dinkle remains the right of product modification and engineering change of the design. The final product is made according to engineering drawing.

## Product Description

24V/60V/110V/250V, 12A, Beige (default)

## General information

Short description	Fuse Terminal Block, Push-in Design
Category	Fuse Terminal Block
Color	Refer to drawing
Connection method	Push-in Design
Type of locking	Rail Mounting
Length (mm)	80.4
Width (mm)	6.1
Height (mm)	64.6 ( TS-35N ) / 72.1 ( TS-35/15N )
Number of positions	≥1P
Level	Single level
Connection points	4

## Material information

Insulation material	PA
---------------------	----

Insulation material group	I
Flame retardant rating , compliant with UL94	V0
Insulation resistance	□500MΩ at DC 500V

## Connection data-IEC

Rated voltage (V)	24/60/110/250
Rated current (A)	6.3 (the Current is determined by the fuse used)
Rated voltage (III/3)(V)	24/60/110/250
Rated impulse voltage (III/3)(KV)	4
Conductor cross section solid. min (mm <sup>2</sup> )	0.14
Conductor cross section solid.max (mm <sup>2</sup> )	4
Conductor cross section stranded. min (mm <sup>2</sup> )	0.14
Conductor cross section stranded. max (mm <sup>2</sup> )	2.5
Conductor cross section flexible, with min ferrule without plastic sleeve (mm <sup>2</sup> )	0.25
Conductor cross section flexible, with max ferrule without plastic sleeve (mm <sup>2</sup> )	2.5
Conductor cross section flexible, with min ferrule with plastic sleeve (mm <sup>2</sup> )	0.25
Conductor cross section flexible, with max ferrule with plastic sleeve (mm <sup>2</sup> )	2.5
2 conductors with same cross section flexible, min twin ferrules with plastic sleeve (mm <sup>2</sup> )	0.5
2 conductors with same cross section flexible, max twin ferrules with plastic sleeve (mm <sup>2</sup> )	0.5
Slotted screwdriver size (Blade thickness x Width)(mm)	0.6x3.5
Stripping Length (mm)	9~10
Mounting rail	TS-35N、TS-35/15N
End cover plate required	YES
Grounding connections	NO

## Connection data-UL

Rated voltage (UL/CUL Group B)(V)	24/60/110/250
Rated current (UL/CUL Group B)(A)	12
Rated voltage (UL/CUL Group C)(V)	24/60/110/250
Rated current (UL/CUL Group C)(A)	12
Min. solid wire connection (AWG) acc. to UL/CUL	26
Max. solid wire connection AWG acc. to UL/CUL	12

Min. stranded wire connection AWG acc. to UL/CUL	26
Max. stranded wire connection AWG acc. to UL/CUL	12

## Environment & Safety

Back of the hand protection (YES or NO)	YES
Finger protection (YES or NO)	YES
Operating temperature. max (°C)	120
Operating temperature. min (°C)	-40

## UL Recognized

Wire Range (Group B)(AWG)	26~12
Rated voltage (Group B)(V)	24/60/110/250
Rated current (Group B)(A)	12
Wire Range (Group C)(AWG)	26~12
Rated voltage (Group C)(V)	24/60/110/250
Rated current (Group C)(A)	12

## CUL Recognized

Wire Range (Group B)(AWG)	26~12
Rated voltage (Group B)(V)	24/60/110/250
Rated current (Group B)(A)	12
Wire Range (Group C)(AWG)	26~12
Rated voltage (Group C)(V)	24/60/110/250
Rated current (Group C)(A)	12

## Drawings

--	--

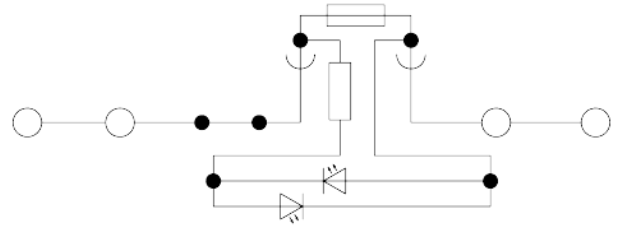
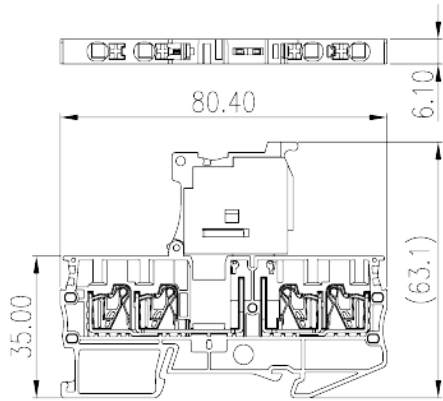

## Approvals

