

BST-120-05

PCB Terminal Blocks > PCB Terminal Blocks

Date:2026-07-05

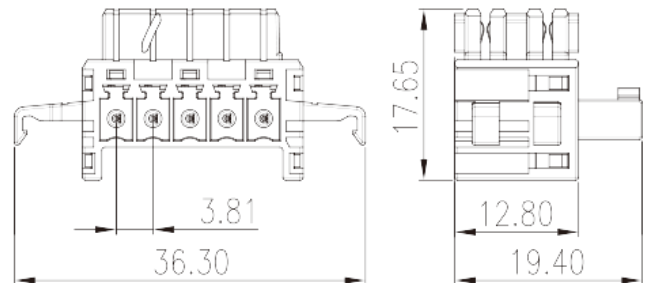
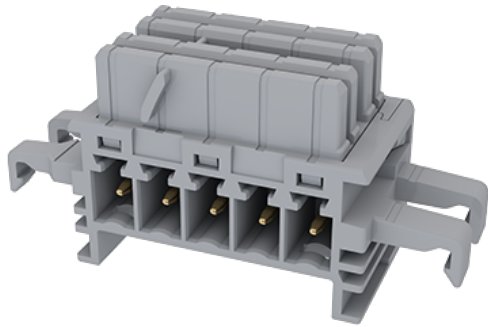

The web catalog is for reference only. Dinkle remains the right of product modification and engineering change of the design. The final product is made according to engineering drawing.

Product Description

Pitch :3.81mm, 150V AC/DC, 8A

General information

Short description	Rail Connector
Category	Rail connector
Pitch (mm)	3.81
Color	Grey (default)
Type of locking	With lock flange
Length (mm)	36.3
Width (mm)	19.4
Height (mm)	17.65
Number of positions	05P
Level	Double level
Connection points	10

Material information

Insulation material	PA
Insulation material group	I
Flame retardant rating , compliant with UL94	V0

Insulation resistance	□500MΩ at DC 500V
Conductor material	COPPER ALLOY
Plating of conductor surface	Au PLATED

Connection data-IEC

Rated voltage (V)	320
Rated current (A)	12
Rated voltage (II/2)(V)	320
Rated voltage (III/2) (V)	160
Rated voltage (III/3)(V)	160
Rated impulse voltage (II/2)(KV)	2.5
Rated impulse voltage (III/2)(KV)	2.5
Rated impulse voltage (III/3)(KV)	2.5

Connection data-UL

Rated voltage (UL/CUL Group B)(V)	150
Rated current (UL/CUL Group B)(A)	8

Environment & Safety

Finger protection (YES or NO)	YES
Operating temperature. max (°C)	120
Operating temperature. min (°C)	-40

UL Recognized

Rated voltage (Group B)(V)	150
Rated current (Group B)(A)	8

CUL Recognized

Rated voltage (Group B)(V)	150
Rated current (Group B)(A)	5

Drawings

--	--

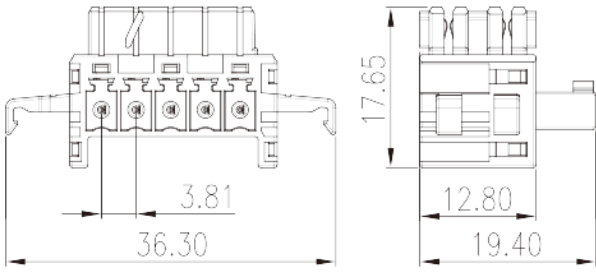

Approvals

