

# 0257-32XX

PCB Terminal Blocks > PCB Connector-Plug

Date:2026-07-06

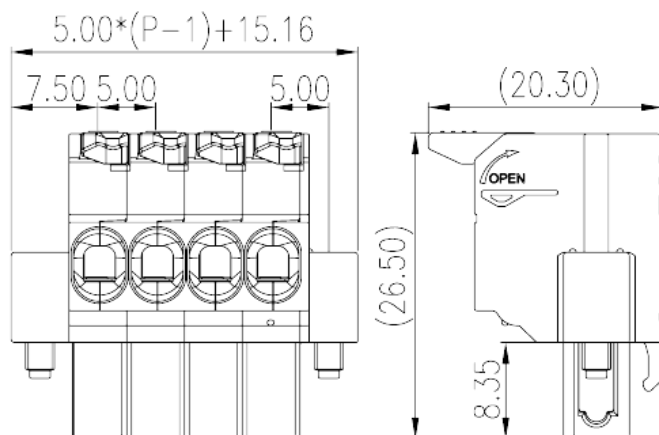

The web catalog is for reference only. Dinkle remains the right of product modification and engineering change of the design. The final product is made according to engineering drawing.

## Product Description

Pitch :5.00mm, 300V, 15A

## General information

|                     |                                    |
|---------------------|------------------------------------|
| Short description   | PCB Connector-Plug, Push-in Design |
| Category            | PCB Connector – Plug               |
| Pitch (mm)          | 5                                  |
| Color               | Green (default)                    |
| Connection method   | Push-in Design                     |
| Type of locking     | With screw flange                  |
| Length (mm)         | $5.00 \times (P-1) + 15$           |
| Width (mm)          | 20.3                               |
| Height (mm)         | 26.5                               |
| Number of positions | 02P~24P                            |
| Level               | Single level                       |
| Connection points   | 02~24                              |

## Material information

|                           |    |
|---------------------------|----|
| Insulation material       | PA |
| Insulation material group | I  |

|  |                   |
|--|-------------------|
| Flame retardant rating , compliant with UL94 | V0                |
| Insulation resistance                        | □500MΩ at DC 500V |
| Conductor material                           | COPPER ALLOY      |
| Plating of conductor surface                 | Tin PLATED        |

## Connection data-IEC

|   |       |
|---|-------|
| Rated voltage (V)   | 630   |
| Rated current (A)   | 18    |
| Rated voltage (II/2)(V)   | 630   |
| Rated voltage (III/2) (V)   | 320   |
| Rated voltage (III/3)(V)  | 320   |
| Rated impulse voltage (II/2)(KV)  | 4     |
| Rated impulse voltage (III/2)(KV)   | 4     |
| Rated impulse voltage (III/3)(KV)   | 4     |
| Conductor cross section solid. min (mm <sup>2</sup> )   | 0.2   |
| Conductor cross section solid.max (mm <sup>2</sup> )  | 2.5   |
| Conductor cross section stranded. min (mm <sup>2</sup> )  | 0.2   |
| Conductor cross section stranded. max (mm <sup>2</sup> )  | 2.5   |
| Conductor cross section flexible, with min ferrule without plastic sleeve (mm <sup>2</sup> )            | 0.25  |
| Conductor cross section flexible, with max ferrule without plastic sleeve (mm <sup>2</sup> )            | 2.5   |
| Conductor cross section flexible, with min ferrule with plastic sleeve (mm <sup>2</sup> )               | 0.25  |
| Conductor cross section flexible, with max ferrule with plastic sleeve (mm <sup>2</sup> )               | 2.5   |
| 2 conductors with same cross section flexible, min twin ferrules with plastic sleeve (mm <sup>2</sup> ) | 0.5   |
| 2 conductors with same cross section flexible, max twin ferrules with plastic sleeve (mm <sup>2</sup> ) | 1.5   |
| Tightening torque with flange. max (N.m)  | 0.3   |
| Stripping Length (mm)   | 10~12 |

## Connection data-UL

|                                   |     |
|-----------------------------------|-----|
| Rated voltage (UL/CUL Group B)(V) | 300 |
| Rated current (UL/CUL Group B)(A) | 15  |
| Rated voltage (UL/CUL Group D)(V) | 300 |
| Rated current (UL/CUL Group D)(A) | 10  |

|  |    |
|--|----|
| Min. solid wire connection (AWG) acc. to UL/CUL  | 26 |
| Max. solid wire connection AWG acc. to UL/CUL    | 12 |
| Min. stranded wire connection AWG acc. to UL/CUL | 26 |
| Max. stranded wire connection AWG acc. to UL/CUL | 12 |

### Environment & Safety

|                                 |     |
|---------------------------------|-----|
| Finger protection (YES or NO)   | YES |
| Operating temperature. max (°C) | 120 |
| Operating temperature. min (°C) | -40 |

### Drawings

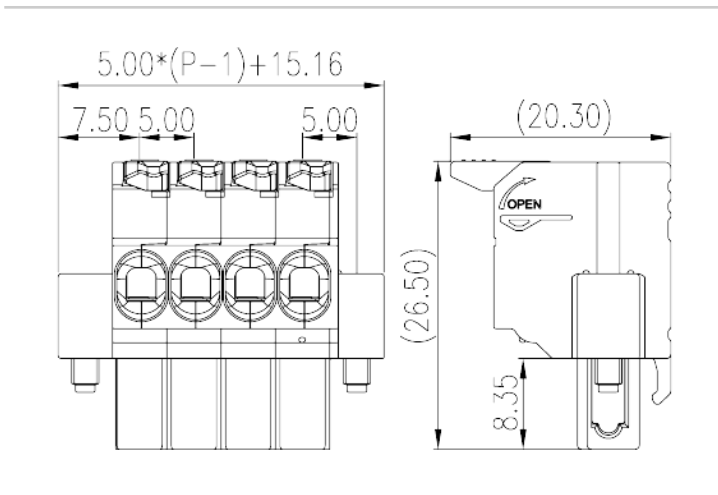

### Approvals

