

# DKB60N-XXPK

NEMA Terminal Blocks > Panel Mounting

Date:2026-05-09

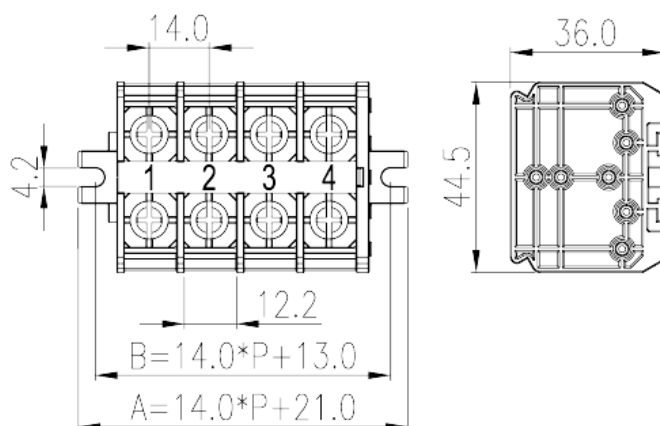

The web catalog is for reference only. Dinkle remains the right of product modification and engineering change of the design. The final product is made according to engineering drawing.

## Product Description

Pitch : 14mm, M5, 600V, 60/90A

## General information

Short description	Panel Mounting, Screw Connection
Category	Panel Mounting
Pitch (mm)	14
Color	Refer to drawing
Connection method	Screw Connection
Length (mm)	$14.00 * P + 21$
Width (mm)	44.5
Height (mm)	36
Number of positions	01P~16P
Level	Single level
Connection points	2~32

## Material information

Insulation material	PC
Insulation material group	Ⅲa
Flame retardant rating , compliant with UL94	V2

Insulation resistance	□1000MΩ at DC 500V
Conductor material	COPPER ALLOY
Plating of conductor surface	Tin PLATED

## Connection data-IEC

Rated voltage (V)	630
Rated current (A)	57/76( with Fork Terminal)
Rated voltage (III/3)(V)	630
Rated impulse voltage (III/3)(KV)	8
Conductor cross section solid. min (mm <sup>2</sup> )	0.5
Conductor cross section solid.max (mm <sup>2</sup> )	10
Conductor cross section stranded. min (mm <sup>2</sup> )	0.5
Conductor cross section stranded. max (mm <sup>2</sup> )	10
2 conductors with same cross section, solid, max (mm <sup>2</sup> )	10
2 conductors with same cross section, stranded, max (mm <sup>2</sup> )	10
Screw thread	M5
Philips screwdriver size	PH2
Rated torque (N.m)	1.6~1.8
Recommend tightening torque. min (N.m)	1.6
Recommend tightening torque. max (N.m)	1.8
Tightening torque with flange. max (N.m)	0.8
Stripping Length (mm)	13~14The stripping length depends on the specification provided by the cablelug manufacturer
Mounting rail	TS-35N · TS-35/15N
End cover plate required	YES
Grounding connections	NO

## Connection data-UL

Rated voltage (UL/CUL Group B)(V)	600
Rated current (UL/CUL Group B)(A)	50A /60A(with Fork Terminal)
Rated voltage (UL/CUL Group C)(V)	600
Rated current (UL/CUL Group C)(A)	50A /60A(with Fork Terminal)
Rated voltage (UL/CUL Group D)(V)	600
Rated current (UL/CUL Group D)(A)	50A /60A(with Fork Terminal)
Min. solid wire connection (AWG) acc. to UL/CUL	20

Max. solid wire connection AWG acc. to UL/CUL	8
Min. stranded wire connection AWG acc. to UL/CUL	20
Max. stranded wire connection AWG acc. to UL/CUL	8

## Environment & Safety

Back of the hand protection (YES or NO)	YES
Finger protection (YES or NO)	NO
Operating temperature. max (°C)	125
Operating temperature. min (°C)	-40

## UL Recognized

Wire Range (Group B)(AWG)	20-6/(2)20-(2)8
Rated voltage (Group B)(V)	600
Rated current (Group B)(A)	60/90
Wire Range (Group C)(AWG)	20-6/(2)20-(2)8
Rated voltage (Group C)(V)	600
Rated current (Group C)(A)	60/90
Wire Range (Group D)(AWG)	20-6/(2)20-(2)8
Rated voltage (Group D)(V)	600
Rated current (Group D)(A)	5

## CUL Recognized

Wire Range (Group B)(AWG)	20-6/(2)20-(2)8
Rated voltage (Group B)(V)	600
Rated current (Group B)(A)	60/90
Wire Range (Group C)(AWG)	20-6/(2)20-(2)8
Rated voltage (Group C)(V)	600
Rated current (Group C)(A)	60/90
Wire Range (Group D)(AWG)	20-6/(2)20-(2)8
Rated voltage (Group D)(V)	600
Rated current (Group D)(A)	5

## Drawings

--	--

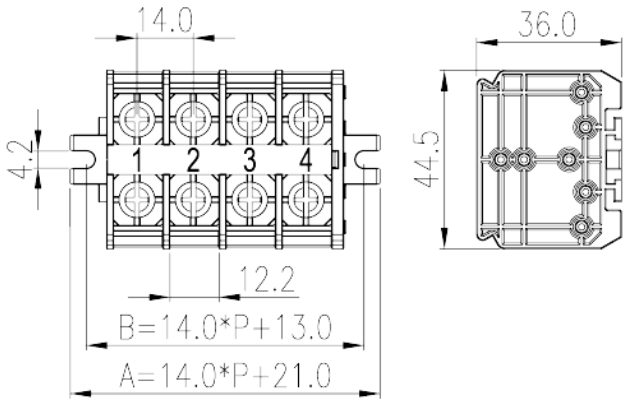

## Approvals

