

# ECH250R-XXP

PCB Terminal Blocks &gt; PCB Connector-Socket

Date:2026-05-09Version:V1

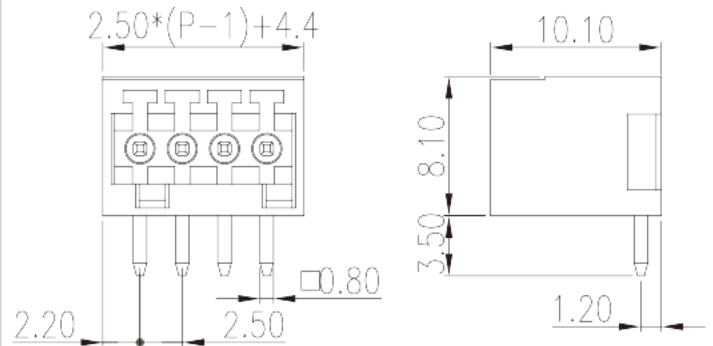
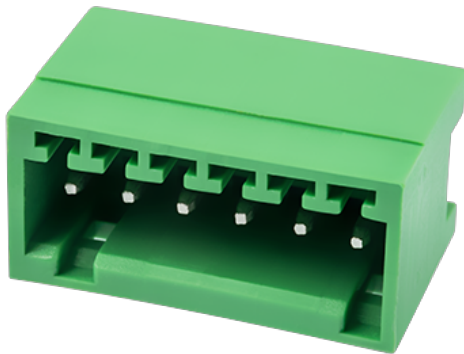

The web catalog is for reference only. Dinkle remains the right of product modification and engineering change of the design. The final product is made according to engineering drawing.

## Product Description

Pitch : 2.50 mm, 150V, 4A

## General information

Short description	PCB Connector – Socket, Wave soldering
Category	PCB Connector – Socket
Pitch (mm)	2.50
Color	Green (default)
Type of locking	Without
Soldering method	Wave soldering
Length (mm)	$2.50 \times (P-1) + 4.4$
Width (mm)	8.1
Height (mm)	10.1
Pin demensions (Thickness x Width)(mm)	0.8x0.8
PCB hole diameter (mm)	1.3
Number of positions	02P~24P
Level	Single level

## Material information

Insulation material	PA
---------------------	----

Insulation material group	I
Flame retardant rating , compliant with UL94	V0
Insulation resistance	□500MΩ at DC 500V
Conductor material	COPPER ALLOY
Plating of conductor surface	Tin PLATED

### Connection data-IEC

Rated voltage (V)	320
Rated current (A)	4
Rated voltage (II/2)(V)	320
Rated voltage (III/2) (V)	160
Rated voltage (III/3)(V)	160
Rated impulse voltage (II/2)(KV)	2.5
Rated impulse voltage (III/2)(KV)	2.5
Rated impulse voltage (III/3)(KV)	2.5

### Connection data-UL

Rated voltage (UL/CUL Group B)(V)	150
Rated current (UL/CUL Group B)(A)	4
Rated voltage (UL/CUL Group D)(V)	150
Rated current (UL/CUL Group D)(A)	4

### Environment & Safety

Finger protection (YES or NO)	YES
Operating temperature. max (°C)	120
Operating temperature. min (°C)	-40

### UL Recognized

Rated voltage (Group B)(V)	150
Rated current (Group B)(A)	4
Rated voltage (Group D)(V)	150
Rated current (Group D)(A)	4

### CUL Recognized

Rated voltage (Group B)(V)	150
----------------------------	-----

Rated current (Group B)(A)	4
Rated voltage (Group D)(V)	150
Rated current (Group D)(A)	4

## Drawings

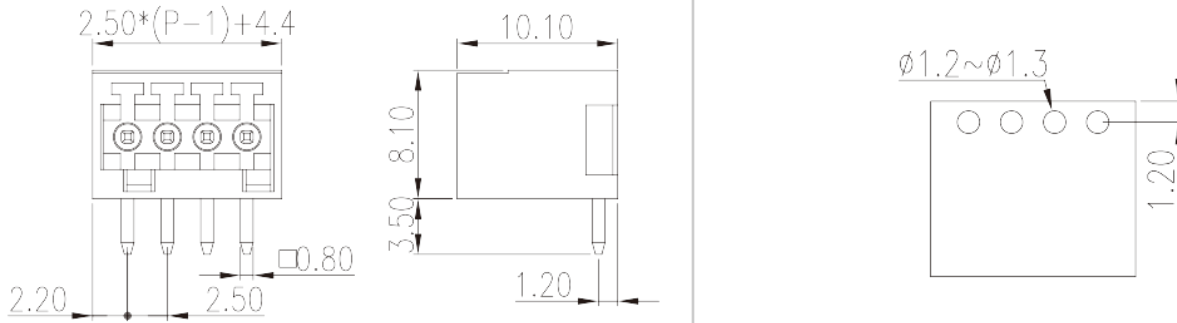

## Approvals

