

DKB80-XXPCK

NEMA Terminal Blocks > Panel Mounting

Date:2026-07-04

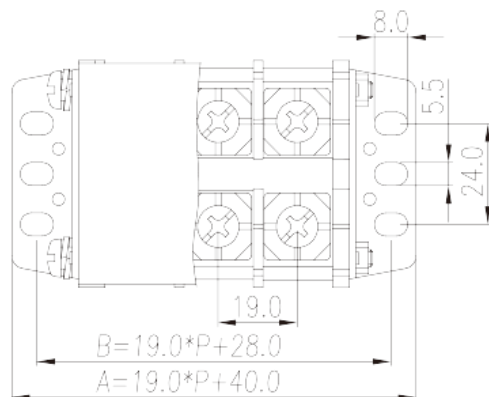

The web catalog is for reference only. Dinkle remains the right of product modification and engineering change of the design. The final product is made according to engineering drawing.

Product Description

Pitch : 19.00mm, M6, 600V, 85A

General information

Short description	Panel Mounting, Screw Connection
Category	Panel Mounting
Pitch (mm)	19.00
Color	Refer to drawing
Connection method	Screw connection
Type of locking	Panel Mounting
Length (mm)	19*P+40
Width (mm)	54
Height (mm)	Refer to drawing
Number of positions	02P~12P
Level	Single level
Connection points	4~24

Material information

Insulation material	PC
Insulation material group	IIIa

Flame retardant rating , compliant with UL94	V2
Insulation resistance	□1000MΩ at DC 500V
Conductor material	COPPER ALLOY
Plating of conductor surface	Ni PLATED

Connection data-IEC

Rated voltage (V)	800
Rated current (A)	76/101
Rated voltage (III/3)(V)	630
Rated impulse voltage (III/3)(KV)	8
Conductor cross section solid. min (mm ²)	0.75
Conductor cross section solid.max (mm ²)	16
Conductor cross section stranded. min (mm ²)	0.75
Conductor cross section stranded. max (mm ²)	16
Screw thread	M6
Philips screwdriver size	PH2
Rated torque (N.m)	3
Recommend tightening torque. min (N.m)	2.5
Recommend tightening torque. max (N.m)	3
Stripping Length (mm)	16~17 The stripping length depends on the specification provided by the cable lug manufacturer
End cover plate required	YES
Grounding connections	NO

Connection data-UL

Rated voltage (UL/CUL Group B)(V)	600
Rated current (UL/CUL Group B)(A)	85
Rated voltage (UL/CUL Group C)(V)	600
Rated current (UL/CUL Group C)(A)	85
Min. solid wire connection (AWG) acc. to UL/CUL	18
Max. solid wire connection AWG acc. to UL/CUL	4
Min. stranded wire connection AWG acc. to UL/CUL	18
Max. stranded wire connection AWG acc. to UL/CUL	4

Environment & Safety

Back of the hand protection (YES or NO)	YES
Finger protection (YES or NO)	NO
Operating temperature. max (°C)	125
Operating temperature. min (°C)	-40

UL Recognized

Wire Range (Group B)(AWG)	18~4
Rated voltage (Group B)(V)	600
Rated current (Group B)(A)	85
Wire Range (Group C)(AWG)	18~4
Rated voltage (Group C)(V)	600
Rated current (Group C)(A)	85

CUL Recognized

Wire Range (Group B)(AWG)	18~4
Rated voltage (Group B)(V)	600
Rated current (Group B)(A)	85
Wire Range (Group C)(AWG)	18~4
Rated voltage (Group C)(V)	600
Rated current (Group C)(A)	85

VDE Approval

Wire Range (mm ²)	0.75~25
Rated voltage (V)	800
Rated current (A)	76(0.75~16mm ²) / 101(25mm ² With Ring terminal)

Drawings

--	--

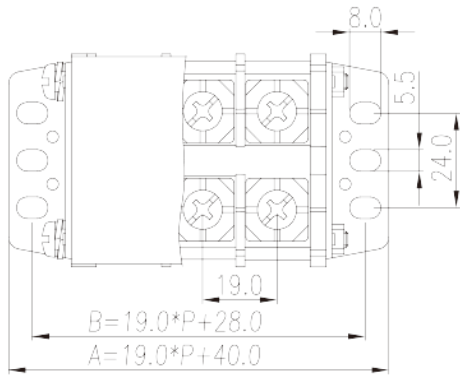

Approvals

