

DKB150-XXPCK

NEMA Terminal Blocks > Panel Mounting

Date:2026-07-04

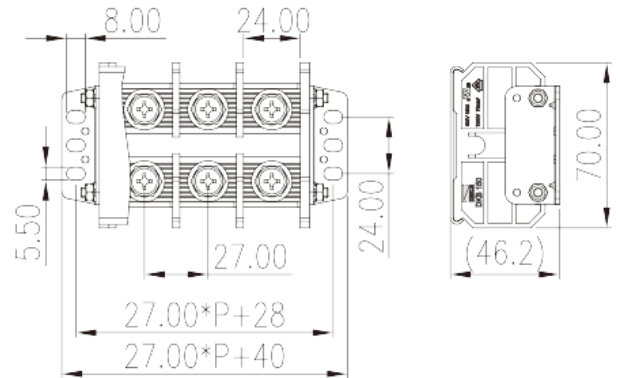
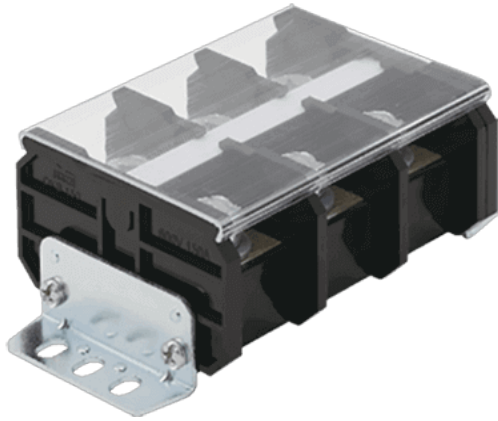

The web catalog is for reference only. Dinkle remains the right of product modification and engineering change of the design. The final product is made according to engineering drawing.

Product Description

Pitch : 27.00mm, M8, 600V, 190A

General information

Short description	Panel Mounting, Screw Connection
Category	Panel Mounting
Pitch (mm)	27.00
Color	Refer to drawing
Connection method	Screw connection
Type of locking	Panel Mounting
Length (mm)	27*P+40
Width (mm)	70
Height (mm)	Refer to drawing
Number of positions	02P~12P
Level	Single level
Connection points	4~24

Material information

Insulation material	PC
Insulation material group	IIIa

Flame retardant rating , compliant with UL94	V2
Insulation resistance	□1000MΩ at DC 500V
Conductor material	COPPER ALLOY
Plating of conductor surface	Ni PLATED

Connection data-IEC

Rated voltage (V)	1000
Rated current (A)	192
Rated voltage (III/3)(V)	1000
Rated impulse voltage (III/3)(KV)	8
Conductor cross section solid. min (mm ²)	10
Conductor cross section solid.max (mm ²)	70
Conductor cross section stranded. min (mm ²)	10
Conductor cross section stranded. max (mm ²)	70
Screw thread	M8
Philips screwdriver size	PH3
Rated torque (N.m)	4.2
Recommend tightening torque. min (N.m)	3.5
Recommend tightening torque. max (N.m)	4.2
Stripping Length (mm)	The stripping length depends on the specification provided by the cable lug manufacturer
End cover plate required	YES
Grounding connections	NO

Connection data-UL

Rated voltage (UL/CUL Group B)(V)	600
Rated current (UL/CUL Group B)(A)	190
Rated voltage (UL/CUL Group C)(V)	600
Rated current (UL/CUL Group C)(A)	190
Min. solid wire connection (AWG) acc. to UL/CUL	8
Max. solid wire connection AWG acc. to UL/CUL	3/0
Min. stranded wire connection AWG acc. to UL/CUL	8
Max. stranded wire connection AWG acc. to UL/CUL	3/0

Environment & Safety

Back of the hand protection (YES or NO)	YES
Finger protection (YES or NO)	NO
Operating temperature. max (°C)	125
Operating temperature. min (°C)	-40

UL Recognized

Wire Range (Group B)(AWG)	8~3/0
Rated voltage (Group B)(V)	600
Rated current (Group B)(A)	190
Wire Range (Group C)(AWG)	8~3/0
Rated voltage (Group C)(V)	600
Rated current (Group C)(A)	190

CUL Recognized

Wire Range (Group B)(AWG)	8~3/0
Rated voltage (Group B)(V)	600
Rated current (Group B)(A)	190
Wire Range (Group C)(AWG)	8~3/0
Rated voltage (Group C)(V)	600
Rated current (Group C)(A)	190

VDE Approval

Wire Range (mm ²)	10~70
Rated voltage (V)	1000
Rated current (A)	192

Drawings

--	--

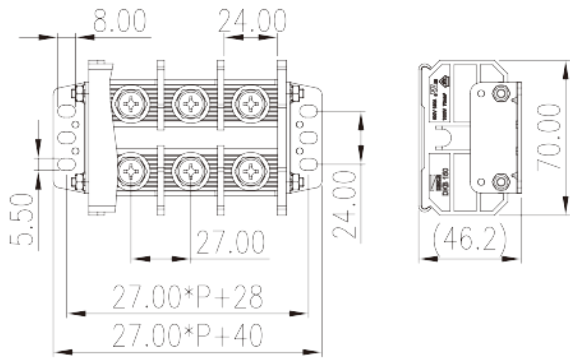

Approvals

