

DKB300

NEMA Terminal Blocks > Rail Mounting

Date:2026-07-04

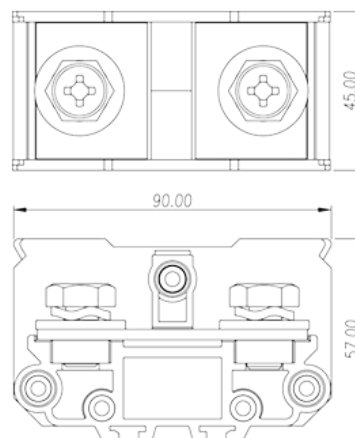
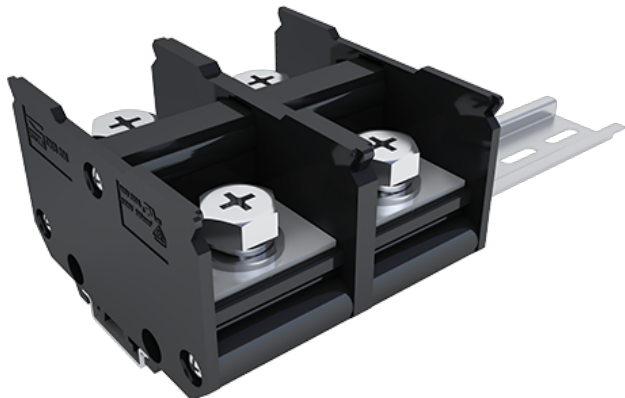

The web catalog is for reference only. Dinkle remains the right of product modification and engineering change of the design. The final product is made according to engineering drawing.

Product Description

M10, 600V, 380A

General information

Short description	Feed-Through single level, Screw Connection
Category	Feed-Through single level
Color	Refer to drawing
Connection method	Screw connection
Type of locking	Rail mounting
Length (mm)	90
Width (mm)	45
Height (mm)	Refer to drawing
Level	Single level
Connection points	2

Material information

Insulation material	PC
Insulation material group	IIIa
Flame retardant rating , compliant with UL94	V2
Insulation resistance	□1000MΩ at DC 500V

Conductor material	COPPER ALLOY
Plating of conductor surface	Ni PLATED

Connection data-IEC

Rated voltage (V)	1000
Rated current (A)	415
Rated voltage (III/3)(V)	1000
Rated impulse voltage (III/3)(KV)	8
Screw thread	M10
Philips screwdriver size	PH4
Rated torque (N.m)	10
Stripping Length (mm)	The stripping length depends on the specification provided by the cable lug manufacturer
Mounting rail	TS-35N · TS-35/15N
Grounding connections	NO

Connection data-UL

Rated voltage (UL/CUL Group B)(V)	600
Rated current (UL/CUL Group B)(A)	380
Rated voltage (UL/CUL Group C)(V)	600
Rated current (UL/CUL Group C)(A)	380
Min. solid wire connection (AWG) acc. to UL/CUL	3/0(With Ring terminals) 2X6 (With Ring terminals)
Max. solid wire connection AWG acc. to UL/CUL	500(kcmil)(With Ring terminals) 2X3/0(With Ring terminals)
Min. stranded wire connection AWG acc. to UL/CUL	3/0(With Ring terminals) 2X6 (With Ring terminals)
Max. stranded wire connection AWG acc. to UL/CUL	500(kcmil)(With Ring terminals) 2X3/0(With Ring terminals)

Environment & Safety

Back of the hand protection (YES or NO)	YES
Finger protection (YES or NO)	NO
Operating temperature. max (°C)	125
Operating temperature. min (°C)	-40

UL Recognized

Wire Range (Group B)(AWG)	3/0~500kcmil 2x(6~3/0)
---------------------------	------------------------

Rated voltage (Group B)(V)	600
Rated current (Group B)(A)	380
Wire Range (Group C)(AWG)	3/0~500kcmil 2x(6~3/0)
Rated voltage (Group C)(V)	600
Rated current (Group C)(A)	380

CUL Recognized

Wire Range (Group B)(AWG)	3/0~500kcmil 2x(6~3/0)
Rated voltage (Group B)(V)	600
Rated current (Group B)(A)	380
Wire Range (Group C)(AWG)	3/0~500kcmil 2x(6~3/0)
Rated voltage (Group C)(V)	600
Rated current (Group C)(A)	380

VDE Approval

Wire Range (mm ²)	70~240
Rated voltage (V)	1000
Rated current (A)	415

Drawings

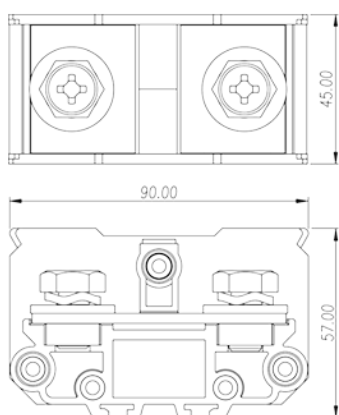

Approvals



