

# DT-49-C01W-XX

Barrier Terminal Blocks &gt; Single Row

Date:2026-05-09Version:1.1

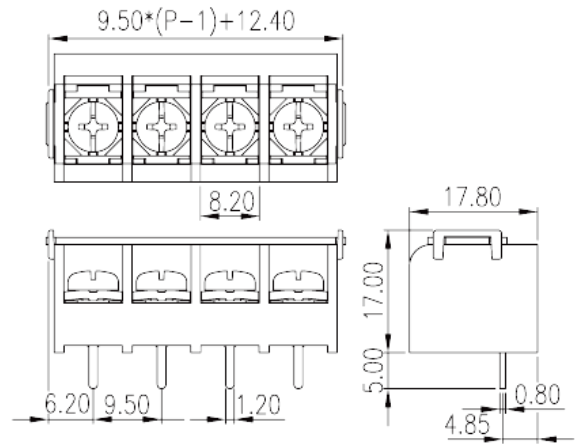
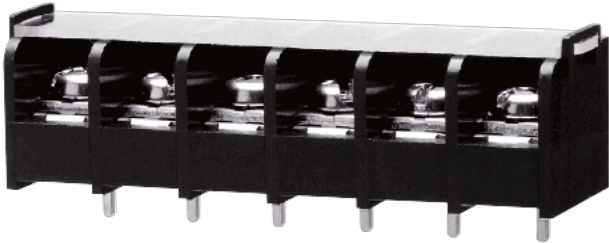

The web catalog is for reference only. Dinkle remains the right of product modification and engineering change of the design. The final product is made according to engineering drawing.

## Product Description

Pitch: 9.50mm , #6-32, 300V, 25A

## General information

Short description	Barrier terminal blocks , Screw connection
Category	Single Row
Pitch (mm)	9.50
Color	Black(default)
Connection method	Screw connection
Type of locking	Without
Pin demensions (Thickness x Width)(mm)	0.8X1.2
PCB hole diameter (mm)	1.6~1.7
Level	Single Row

## Material information

Insulation material	PA66
Insulation material group	I
Flame retardant rating , compliant with UL94	V0
Conductor material	Copper Alloy
Plating of conductor surface	Tinned

## Connection data-IEC

Rated current (A)	32
Rated voltage (II/2)(V)	1000
Rated voltage (III/2) (V)	630
Rated voltage (III/3)(V)	400
Rated impulse voltage (II/2)(KV)	6
Rated impulse voltage (III/2)(KV)	6
Rated impulse voltage (III/3)(KV)	6
Conductor cross section solid. min (mm <sup>2</sup> )	0.34
Conductor cross section solid.max (mm <sup>2</sup> )	4
Conductor cross section stranded. min (mm <sup>2</sup> )	0.34
Conductor cross section stranded. max (mm <sup>2</sup> )	2.5
2 conductors with same cross section, solid, max (mm <sup>2</sup> )	1.5
2 conductors with same cross section, stranded, max (mm <sup>2</sup> )	1.5
Screw thread	#6-32
Slotted screwdriver size (Blade thickness x Width)(mm)	0.8x4.0
Philips screwdriver size	PH2
Rated torque (N.m)	1.4
Recommend tightening torque. min (N.m)	0.8
Recommend tightening torque. max (N.m)	1.4
Stripping Length (mm)	8~9

## Connection data-UL

Rated voltage (UL/CUL Group B)(V)	300
Rated current (UL/CUL Group B)(A)	25
Rated voltage (UL/CUL Group D)(V)	300
Rated current (UL/CUL Group D)(A)	10
Min. solid wire connection (AWG) acc. to UL/CUL	22
Max. solid wire connection AWG acc. to UL/CUL	12
Min. stranded wire connection AWG acc. to UL/CUL	22
Max. stranded wire connection AWG acc. to UL/CUL	12

## Environment & Safety

Back of the hand protection (YES or NO)	YES
---	-----

Operating temperature. max (°C)	11.005
Operating temperature. min (°C)	-40

## UL Recognized

Wire Range (Group B)(AWG)	22~12
Rated voltage (Group B)(V)	300
Rated current (Group B)(A)	25
Wire Range (Group C)(AWG)	22~12
Wire Range (Group D)(AWG)	22~12
Rated voltage (Group D)(V)	300
Rated current (Group D)(A)	10

## CUL Recognized

Wire Range (Group B)(AWG)	22~12
Rated voltage (Group B)(V)	300
Rated current (Group B)(A)	25
Wire Range (Group C)(AWG)	22~12
Wire Ranget (Group D)(AWG)	22~12
Rated voltage (Group D)(V)	300
Rated current (Group D)(A)	10

## VDE Approval

Wire Range (mm <sup>2</sup> )	0.34~4
Rated current (A)	32

## Drawings

--	--

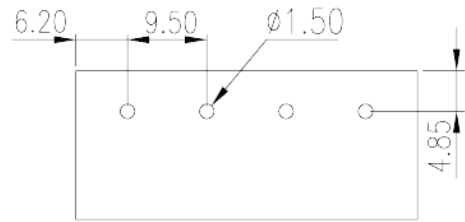
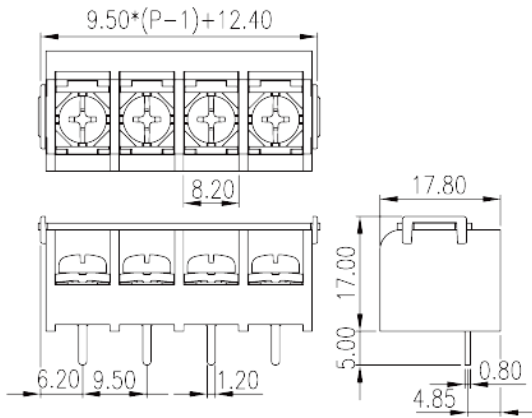

## Approvals

