

DT-65-B01W-XX

Barrier Terminal Blocks > Single Row

Date:2026-05-09Version:1.1

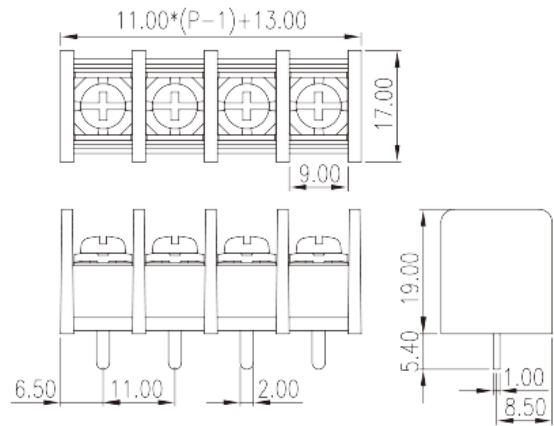
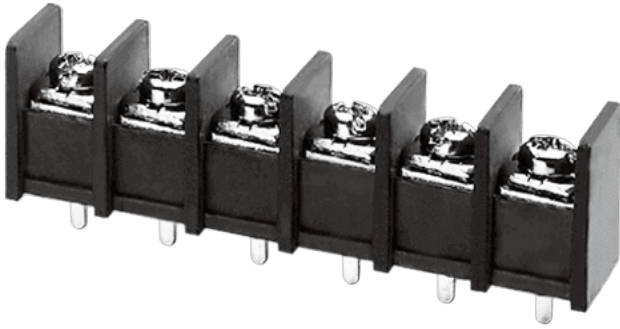

The web catalog is for reference only. Dinkle remains the right of product modification and engineering change of the design. The final product is made according to engineering drawing.

Product Description

Pitch: 11.00mm , M4, 300V, 25A

General information

Short description	Barrier terminal blocks, Screw connection
Category	Single Row
Pitch (mm)	11.00
Color	Black(default)
Connection method	Screw connection
Type of locking	Without
Pin demensions (Thickness x Width)(mm)	1.0X2.0
PCB hole diameter (mm)	1.2x3.4
Level	Single Row

Material information

Insulation material	PA66
Insulation material group	I
Flame retardant rating , compliant with UL94	V0
Conductor material	Copper Alloy
Plating of conductor surface	Tinned

Connection data-IEC

Rated current (A)	32
Rated voltage (II/2)(V)	1000
Rated voltage (III/2) (V)	630
Rated voltage (III/3)(V)	500
Rated impulse voltage (II/2)(KV)	6
Rated impulse voltage (III/2)(KV)	6
Rated impulse voltage (III/3)(KV)	6
Conductor cross section solid. min (mm ²)	0.34
Conductor cross section solid.max (mm ²)	4
Conductor cross section stranded. min (mm ²)	0.34
Conductor cross section stranded. max (mm ²)	4
2 conductors with same cross section, solid, max (mm ²)	2.5
2 conductors with same cross section, stranded, max (mm ²)	2.5
Screw thread	M4
Slotted screwdriver size (Blade thickness x Width)(mm)	1.0x5.5
Philips screwdriver size	PH2
Rated torque (N.m)	1.8
Recommend tightening torque. min (N.m)	1.2
Recommend tightening torque. max (N.m)	1.8
Stripping Length (mm)	11~12

Connection data-UL

Rated voltage (UL/CUL Group B)(V)	300
Rated current (UL/CUL Group B)(A)	25
Rated voltage (UL/CUL Group C)(V)	150
Rated current (UL/CUL Group C)(A)	25
Rated voltage (UL/CUL Group D)(V)	300
Rated current (UL/CUL Group D)(A)	10
Min. solid wire connection (AWG) acc. to UL/CUL	22
Max. solid wire connection AWG acc. to UL/CUL	12
Min. stranded wire connection AWG acc. to UL/CUL	22
Max. stranded wire connection AWG acc. to UL/CUL	12

Environment & Safety

Back of the hand protection (YES or NO)	YES
Operating temperature. max (°C)	120
Operating temperature. min (°C)	-40

UL Recognized

Wire Range (Group B)(AWG)	22~12
Rated voltage (Group B)(V)	300
Rated current (Group B)(A)	25
Wire Range (Group C)(AWG)	22~12
Rated voltage (Group C)(V)	150
Rated current (Group C)(A)	25
Wire Range (Group D)(AWG)	22~12
Rated voltage (Group D)(V)	300
Rated current (Group D)(A)	10

CUL Recognized

Wire Range (Group B)(AWG)	22~12
Rated voltage (Group B)(V)	300
Rated current (Group B)(A)	25
Wire Range (Group C)(AWG)	22~12
Rated voltage (Group C)(V)	150
Rated current (Group C)(A)	25
Wire Ranget (Group D)(AWG)	22~12
Rated voltage (Group D)(V)	300
Rated current (Group D)(A)	10

VDE Approval

Wire Range (mm ²)	0.34~4
Rated current (A)	32

Drawings

--	--

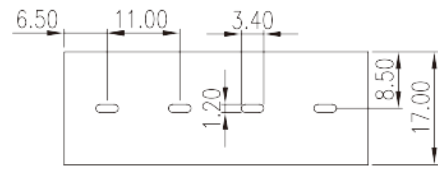
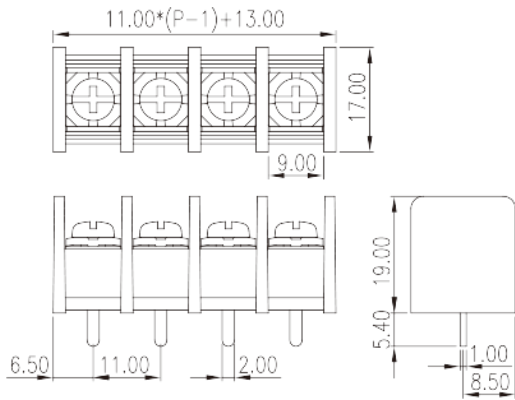

Approvals

