

# 0168-42XX

Barrier Terminal Blocks &gt; Panel Feed-Through

Date:2026-07-04Version:1.1

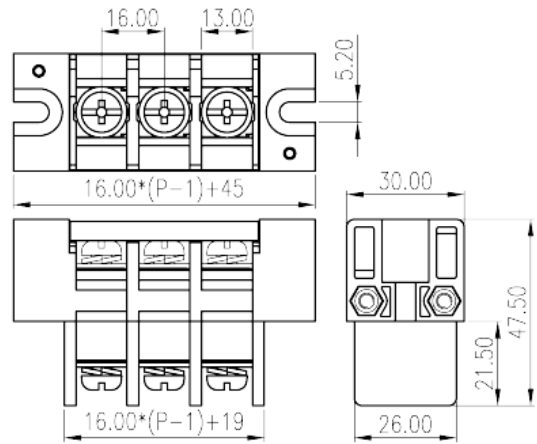
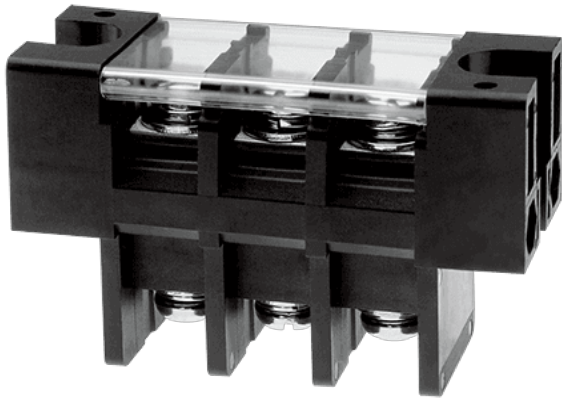

The web catalog is for reference only. Dinkle remains the right of product modification and engineering change of the design. The final product is made according to engineering drawing.

## Product Description

Pitch: 16mm, M6, 600V, 115A

## General information

Short description	Barrier terminal blocks, Screw connection
Category	Panel Feed Through Terminal Blocks
Pitch (mm)	16
Color	Black (default)
Connection method	Screw connection
Type of locking	With mounting flange
Level	Single level

## Material information

Insulation material	PBT
Insulation material group	IIIa
Flame retardant rating , compliant with UL94	V0
Conductor material	Copper Alloy
Plating of conductor surface	Tinned

## Connection data-IEC

Rated current (A)	125
Rated voltage (II/2)(V)	1000
Rated voltage (III/2) (V)	1000
Rated voltage (III/3)(V)	1000
Rated impulse voltage (II/2)(KV)	8
Rated impulse voltage (III/2)(KV)	8
Rated impulse voltage (III/3)(KV)	8
Conductor cross section solid. min (mm <sup>2</sup> )	2.5
Conductor cross section solid.max (mm <sup>2</sup> )	35
Conductor cross section stranded. min (mm <sup>2</sup> )	2.5
Conductor cross section stranded. max (mm <sup>2</sup> )	35
2 conductors with same cross section, solid, max (mm <sup>2</sup> )	35
2 conductors with same cross section, stranded, max (mm <sup>2</sup> )	35
Screw thread	M6
Slotted screwdriver size (Blade thickness x Width)(mm)	1.2x6.5
Philips screwdriver size	PH3
Rated torque (N.m)	2.5
Recommend tightening torque. min (N.m)	2.5
Recommend tightening torque. max (N.m)	3
Stripping Length (mm)	The stripping length depends on the specification provided by the cable manufacturer.

## Connection data-UL

Rated voltage (UL/CUL Group B)(V)	600
Rated current (UL/CUL Group B)(A)	115
Rated voltage (UL/CUL Group C)(V)	600
Rated current (UL/CUL Group C)(A)	115
Min. solid wire connection (AWG) acc. to UL/CUL	14
Max. solid wire connection AWG acc. to UL/CUL	2
Min. stranded wire connection AWG acc. to UL/CUL	14
Max. stranded wire connection AWG acc. to UL/CUL	2

## Environment & Safety

Back of the hand protection (YES or NO)	YES
Operating temperature. max (°C)	130

Operating temperature. min (°C)

-40

## UL Recognized

Wire Range (Group B)(AWG)	14~2
Rated voltage (Group B)(V)	600
Rated current (Group B)(A)	115
Wire Range (Group C)(AWG)	14~2
Rated voltage (Group C)(V)	600
Rated current (Group C)(A)	115

## CUL Recognized

Wire Range (Group B)(AWG)	14~2
Rated voltage (Group B)(V)	600
Rated current (Group B)(A)	115
Wire Range (Group C)(AWG)	14~2
Rated voltage (Group C)(V)	600
Rated current (Group C)(A)	115

## Drawings

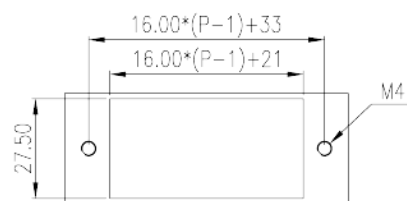
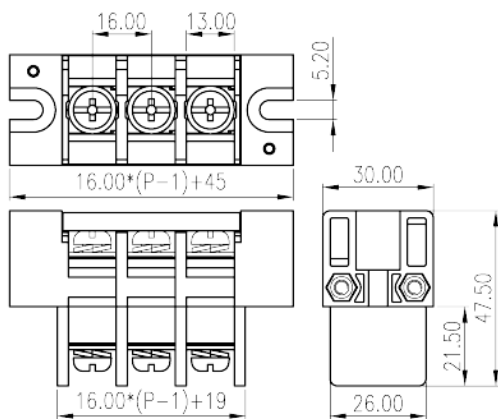

## Approvals



