

# P-831N

Barrier Terminal Blocks &gt; Wire Terminal

Date:2026-07-04Version:1.2

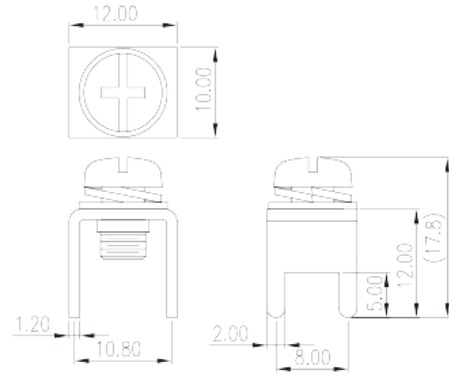

The web catalog is for reference only. Dinkle remains the right of product modification and engineering change of the design. The final product is made according to engineering drawing.

## Product Description

Pitch : 8.00 /10.80 mm ,1.2x2.0mm, 85A

## General information

Short description	Barrier terminal blocks , Quick terminal blocks
Category	Quick terminal blocks
Pitch (mm)	8.00 / 10.80
Pin demensions (Thickness x Width)(mm)	1.2x2.0

## Material information

Conductor material	Copper Alloy
Plating of conductor surface	Tinned

## Connection data-IEC

Screw thread	M5
Slotted screwdriver size (Blade thickness x Width)(mm)	1.0x5.5
Philips screwdriver size	PH2
Recommend tightening torque. min (N.m)	2
Recommend tightening torque. max (N.m)	2.4

## VDE Approval

Rated current (A)	85
-------------------	----

## Drawings

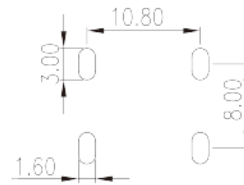
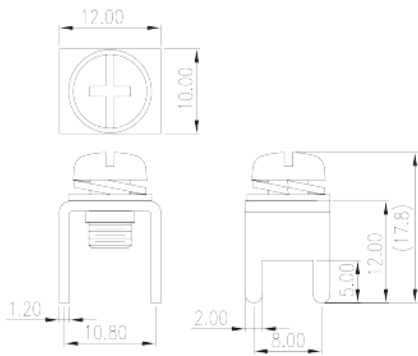

## Approvals

