

# P-861

Blocos Terminais de Barreira &gt; Terminal de fio

Date:2026-05-12Version:1.2

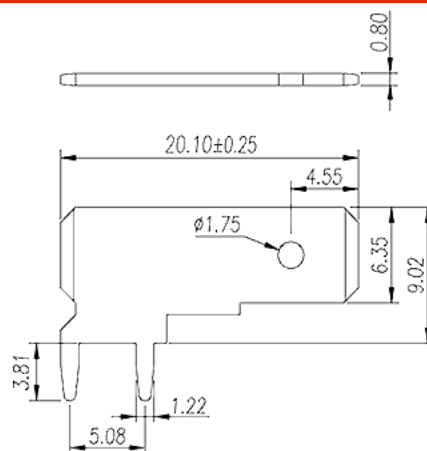
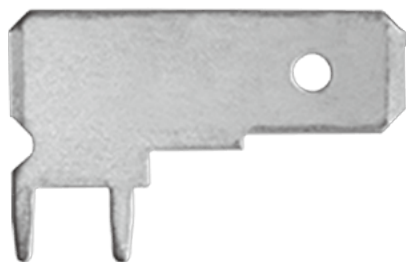

The web catalog is for reference only. Dinkle remains the right of product modification and engineering change of the design. The final product is made according to engineering drawing.

## Descrição do Produto

Pitch : 5.08mm, 0.8x1.22mm, 30A

## Informação geral

Pequena descrição	Barrier terminal blocks, Quick terminal blocks
Categoria	Quick terminal blocks
Espaçamento (mm)	5.08
Dimensões do pino (espessura x largura) (mm)	0.8x1.22

## Informações materiais

Material do condutor	COPPER ALLOY
Chapeamento de superfície condutor	Tin PLATED

## Dados de conexão-IEC

Corrente nominal (A)	30
----------------------	----

## Desenhos

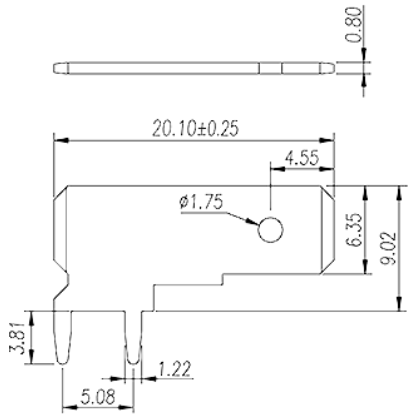

## Aprovações

