

P-851

Blocos Terminais de Barreira > Terminal de fio

Date:2026-06-26Version:1.2

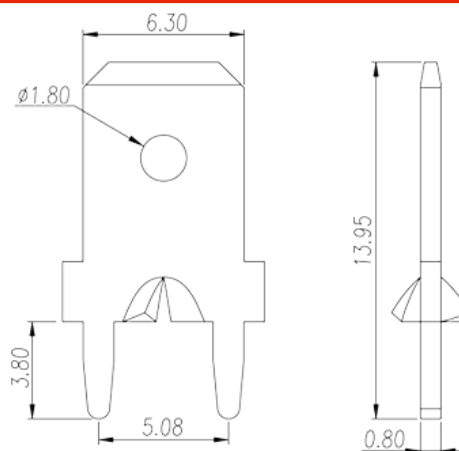
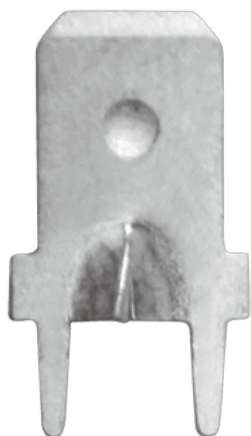

The web catalog is for reference only. Dinkle remains the right of product modification and engineering change of the design. The final product is made according to engineering drawing.

Descrição do Produto

Pitch : 5.08mm, 0.8x1.2mm, 30A

Informação geral

Pequena descrição	Barrier terminal blocks, Quick terminal blocks
Categoria	Quick terminal blocks
Espaçamento (mm)	5.08
Dimensões do pino (espessura x largura) (mm)	0.8x1.2

Informações materiais

Material do condutor	COPPER ALLOY
Chapeamento de superfície condutor	Tin PLATED

Dados de conexão-IEC

Corrente nominal (A)	30
----------------------	----

Desenhos

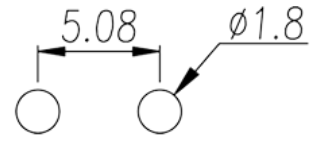
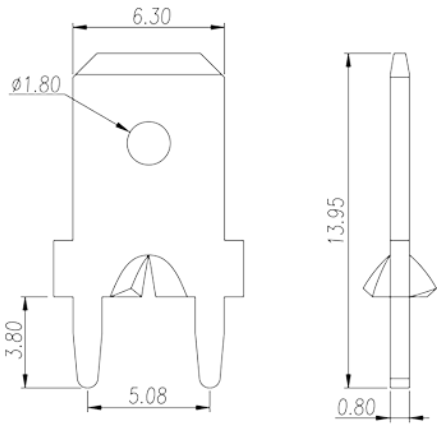

Aprovações

