

P-620

Blocos Terminais de Barreira > Terminal de fio

Date:2026-05-12Version:1.2

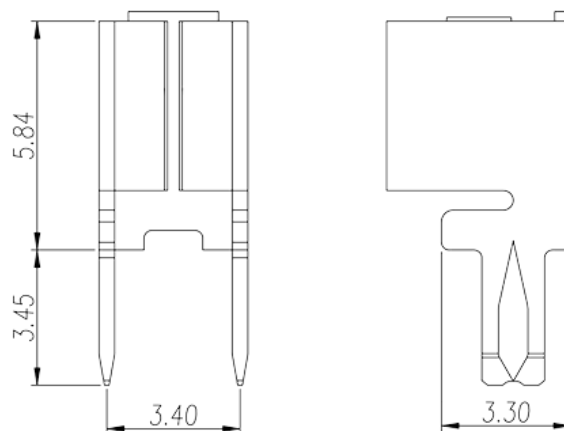
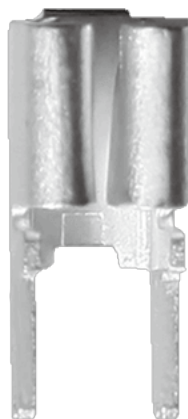

The web catalog is for reference only. Dinkle remains the right of product modification and engineering change of the design. The final product is made according to engineering drawing.

Descrição do Produto

Pitch : 3.40mm, 0.4x1.6mm, 20A

Informação geral

| | |
|--|--|
| Pequena descrição | Barrier terminal blocks, Quick terminal blocks |
| Categoria | Quick terminal blocks |
| Espaçamento (mm) | 3.40 |
| Dimensões do pino (espessura x largura) (mm) | 0.4x1.6 |

Informações materiais

| | |
|------------------------------------|--------------|
| Material do condutor | COPPER ALLOY |
| Chapeamento de superfície condutor | Tin PLATED |

Dados de conexão-IEC

| | |
|----------------------|----|
| Corrente nominal (A) | 20 |
|----------------------|----|

Desenhos

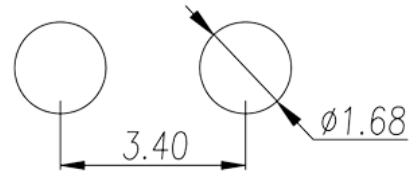
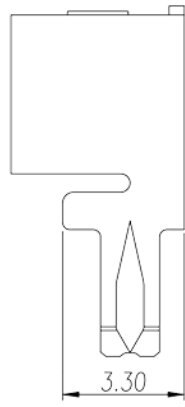
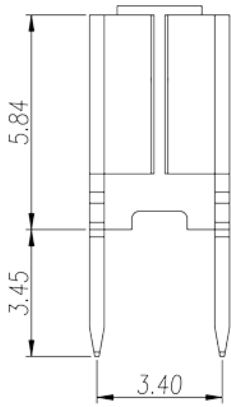

Aprovações

