

P-872

柵板式端子台 > 獨立端子

下載日期:2026-06-14版次:1.2

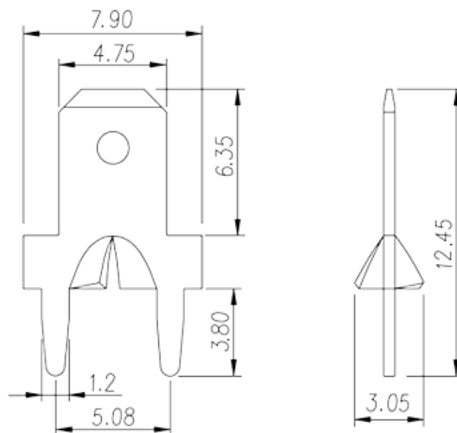
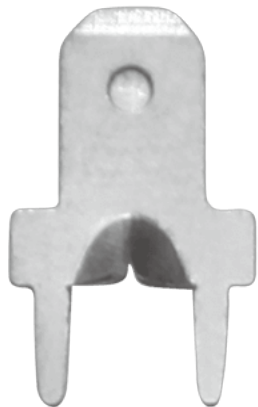

目錄僅供參考，實際規格仍依照產品工程圖面為準

產品介紹

Pitch : 5.08mm, 0.5x1.2mm, 30A

一般資訊

產品概述	Barrier terminal blocks, Quick terminal blocks
產品類型	Quick terminal blocks
產品間距 (mm)	5.08
出腳尺寸 (厚度___ x 寬度___mm)	0.5x1.2

材料資訊

導體材料	COPPER ALLOY
導體表面鍍層	Tin PLATED

連接數據-IEC

額定電流 (A)	30
----------	----

圖面

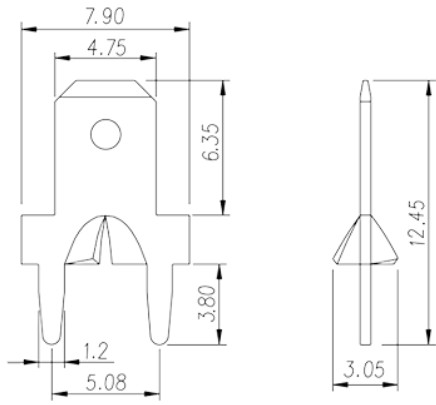

認證

