

**DINKLE ENTERPRISE CO., LTD.**

No. 19, Wuquan 2nd Road, Wugu District,  
New Taipei City 248020, Taiwan  
TEL:+886-2-8069-9000 7705-6900  
FAX:+886-2-2290-1705  
E-mail:service@dinkle.com  
Web:www.dinkle.com

**DINKLE INTERNATIONAL CO., LTD.**

No. 19, Wuquan 2nd Road, Wugu District,  
New Taipei City 248020, Taiwan  
TEL:+886-2-8069-9000 7705-6900  
FAX:+886-2-2290-1703  
E-mail:service@dinkle.com  
Web:www.dinkle.com

**OPTIKLE INTERNATIONAL CO., LTD.**

Unit 29, 1/F, Block B, Proficient Industrial Center,  
No 6, Wang Kwun Rd., Kowloon Bay,  
Kowloon, Hong Kong  
TEL:+852-2795-3840 2758-8005  
FAX:+852-2753-6919  
E-mail:Service.LY.Sales@dinkle.com.cn  
Web:www.dinkle.com

**DINKLE ELECTRIC MACHINERY (CHINA) CO., LTD.**

No. 388, Xingpu Mid Road, Shipu , Qiandeng Town,  
Kunshan City, Jiangsu Province 215343, China  
TEL:+86-512-5708-8588  
FAX:+86-512-5708-8600  
E-mail:Service.SH.Sales@dinkle.com.cn  
Web:www.dinkle.com/ks-cn/

**LI YANG ELECTRIC MACHINERY (DONGGUAN) CO., LTD.**

No.2 1st Street, Jinqianling, Huangjiang Town,  
Dongguan City, Guangdong Province 523757, China  
TEL:+86-769-8336-4350 8336-4370  
FAX:+86-769-8384-8634  
E-mail:Service.LY.Sales@dinkle.com.cn  
Web:www.dinkle.com

**DINKLE CORPORATION, USA**

13748 Pike Road, Missouri City, Texas 77489, United States  
TEL: +1-832-391-8231  
Toll-Free:+1-844-273-1850  
FAX:+1-832-532-7226  
E-mail:Service.US.Sales@dinkle.com  
Web:www.dinkle.com/en/home

**DINKLE S.R.L., ITALY**

Via Stabilini 14, Malgrate Lombardia 23864, Italia  
TEL:+39-34-1171-6154  
E-mail:Service.It.Sales@dinkle.com  
Web:www.dinkle.com/it/

**DINKLE ELECTRIC TRADING (SHANGHAI) CO., LTD.**

Unit 3708, 2 Grand Gateway, No. 3 Hongqiao Road,  
Xuhui District, Shanghai City 200030, China  
TEL:+86-21-6487-0636 6487-5423  
FAX:+86-21-3356-2500  
E-mail:Service.SH.Sales@dinkle.com.cn  
Web:www.dinkle.com/cn/

**Beijing Sales Office**

TEL:+86-10-5873-4338  
FAX:+86-10-5873-4337  
E-mail: Service.SH.Sales@dinkle.com.cn  
Web: www.dinkle.com/cn/



E-mail : service@dinkle.com

Web : www.dinkle.com

Dinkle remains the right of product modification and engineering change of design.  
The catalogue is for reference only. The final product is made according to actual  
engineering drawing.

弊社標準品に関しては、修正や設計変更等が行われるため、カタログは参考であり、  
詳細仕様は図面を基準とする。

本公司對產品保有修改、設變權，目錄僅供參考，實際產品仍需依照工程圖面  
為準。

JUL./2025\_V.03

# Circular Connector

M5 / M8 / M12 / M23 / 7/8" Series

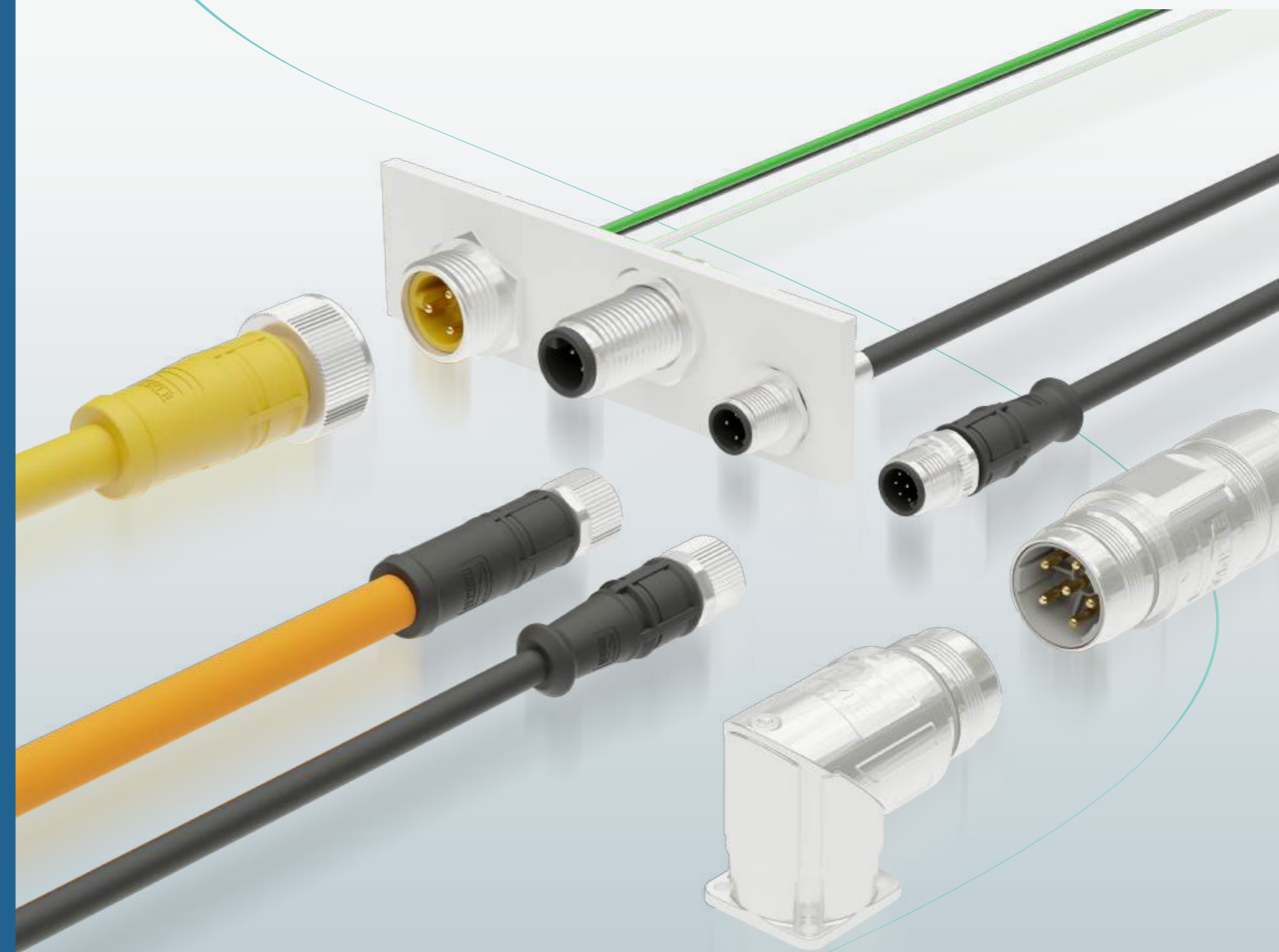



## Delight Through Connections

Dinkle Group was established in 1983, and since that time has insisted on constant innovation and preserving an excellent craftsman's spirit. Starting with a core business of terminal block manufacturing, Dinkle has expanded to provide many outstanding products, deliver highly efficient global service, and promote close connections with end users.

Dinkle has accumulated extensive experience through close cooperation with global customers and application of advanced technologies in the market. Attentively listening to customers, correctly understanding their needs and accurately providing solutions are the key to Dinkle's success and creates end users' satisfaction. Customer support and trust increases our continuous passion and motivation to continue innovating.

Dinkle appreciates our role as an ideal win-win partner for your diverse needs; let us **Delight Through Connections!!**

## M5 / M8 / M12 / M23 / 7/8" Circular Connector



## Product Feature

- Fully gold-plated contacts
- Pre-assembled cables, fast connection
- IP68 protection - waterproof and dustproof
- Vibration and shock resistance
- Shielded option available, 360° protection
- International Specification
- RoHS and CE compliant

## Effortless and Simple On-site Wiring Solution

With the growing industrial automation system, need a reliable power, signal and data transmission; a standardized connector but personalized cable and wiring solutions. Whether you need signal cables for sensor, or Ethernet cables for data communication, Dinkle is able to provide the best solution for every application.

Dinkle standard M5-7/8" circular connector features high stability and tightness. Meeting IP67 rating and higher, our connectors allow reliable connection solution in extreme environments with humidity, large temperature changes, and vibrations. Dinkle provides single and double-ended straight and angled molded connector with PVC and PUR cables for quick field wiring and improves the overall productivity.

## Product Advantage



### Easy to Assemble; Universal Interface

- Fully gold-plated contacts, effectively transmit signal without interruption
- IP68 Rating

### High Shock Resistance Design

- Meets UL2237/UL2238 safety test requirement
- Designed in accordance with IEC 61076-2-101/104/111, 360° fully shielded

### Customized Service

- Multiple color options
- Cable lengths and prints can be customized, PUR and PVC cables available.



# Index

## Universal Signal & Power

Connector Code	Connector Type	Shielding	Material	Page	
M5	Molded Connector	No Shield		P.4	
	Device Connector	No Shield - Wire : PVC		P.7	
	PCB Connector	One-piece	No Shield	P.9	
M8	Molded Connector	Shield		P.13	
		No Shield		P.14 - P.15	
	Device Connector	No Shield - Wire : PVC		P.19	
		No Shield - Solder cup			
	PCB Connector	One-piece	No Shield	P.22	
		Two-piece	No Shield	P.25	
	B-Code	Molded Connector	Shield		P.28
			No Shield		P.29 - P.30
		Device Connector	No Shield - Wire : PVC		P.33
	No Shield - Solder cup				
PCB Connector	One-piece	No Shield	P.35		
M12	Molded Connector	Shield		P.39	
		No Shield		P.40	
		No Shield - Drag chain		P.41	
		No Shield - Molded Y-Splitter		P.42	
	Device Connector	Shield - PUR Cable		P.45	
		No Shield - Wire : PVC		P.46	
		No Shield - Solder cup			
	PCB Connector	One-piece	Shield / No Shield	P.50	
		Two-piece	Shield / No Shield	P.53	
	Assembly Connector	Solder	Shield / No Shield	P.55	
				P.58	
	B-Code	Molded Connector	Shield		P.59
		No Shield		P.60	
		No Shield - Drag chain		P.60	
Device Connector		Shield - PUR Cable		P.63	
		No Shield - Wire : PVC		P.64	
		No Shield - Solder cup			
PCB Connector	One-piece	Shield / No Shield	P.68		
	Two-piece	Shield / No Shield	P.71		
Assembly Connector	Solder	Shield / No Shield	P.73		
D-Code	Molded Connector	Shield		P.76	
		No Shield		P.77	
		No Shield - Drag chain		P.78	
	Device Connector	Shield - PUR Cable		P.81	
		No Shield - Wire : PVC		P.82	
		No Shield - Solder cup			

# Index

## Universal Signal & Power

<b>M12</b>	D-Code	PCB Connector	One-piece	Shield / No Shield	P.86
			Two-piece	Shield / No Shield	P.89
		Assembly Connector	Solder	Shield / No Shield	P.91
	S-Code	Molded Connector	No Shield		P.94
		Device Connector	No Shield - Wire : PVC		P.97
	T-Code	Molded Connector	No Shield		P.100
		Device Connector	No Shield - Wire : PVC		P.103
		PCB Connector	One-piece	Shield / No Shield	P.106
	X-Code	PCB Connector	Two-piece	Shield	P.108
		Molded Connector	No Shield		P.111
	L-Code	Device Connector	No Shield - Wire : PVC		P.114
		PCB Connector	One-piece	Shield / No Shield	P.117
			Two-piece	Shield / No Shield	P.120
	K-Code	Molded Connector	Shield / No Shield		P.123
Device Connector		No Shield - Wire : PVC		P.126	
M-Code	Molded Connector	Shield / No Shield		P.129	
	Device Connector	No Shield - Wire : PVC		P.132	
<b>M23</b>	N-Code	Power	Power	P.136	
		Signal	Signal	P.137	
<b>7/8"</b>	A-Code	Molded Connector	No Shield	P.140	
		Device Connector	No Shield - Wire : PVC	P.142	
	PCB Connector	One-piece	No Shield	P.144	
<b>Distribution Box</b>	Features & Products				P.145
	Dimension & Application				P.146
	Product Information				P.147

## Industrial Ethernet

<b>M12</b>	A-Code	Molded Connector	Ethernet(PUR)	P.151
			CC-Link(PVC)	P.152
			CANopen(PUR)	P.155
	A-Code	Device Connector	Ethernet(PUR)	P.155
			CC-Link(PVC)	P.156
			CANopen(PUR)	P.156
	PCB Connector	Ethernet(PUR)		
		CC-Link(PVC)		P.159
		CANopen(PUR)		
	B-Code	Molded Connector	PROFIBUS(PUR)	P.162
		Device Connector	PROFIBUS(PUR)	P.165
		PCB Connector	PROFIBUS(PUR)	P.168
	D-Code	Molded Connector	PROFINET(PVC)	P.171
			Ethernet(PUR)	
PROFINET(PVC)			P.174	
Device Connector	PROFINET(PVC)			
	Ethernet(PUR)			

# Index

## Industrial Ethernet

<b>M12</b>	D-Code	PCB Connector	PROFINET(PVC)	P.176
			Ethernet(PUR)	
X-Code	Molded Connector	Ethernet(PUR)	P.179	
		PCB Connector	Ethernet(PUR)	P.181
<b>Functional</b>				
<b>M8</b>	A-Code	Molded Connector	Ethernet(PUR)	P.185
		Molded Connector	Ethernet(PUR)	P.188
<b>M12</b>	D-Code	Molded Connector	PROFINET(PVC)	P.194
			Ethernet(PUR)	
	Device Connector	PROFINET(PVC)	P.197	
		Ethernet(PUR)		
X-Code	Molded Connector	Ethernet(PUR)	P.200	
<b>Accessories</b>				P.201

# M5 Circular Connector

Dinkle's M5 circular connectors are designed with high reliability and airtightness. With a compact form factor, they are ideal for more compact devices, offering additional communication points within limited spaces.

To meet the needs of various industrial applications, Dinkle provides high-quality PVC and PUR cables. PVC cables are an excellent choice for chemical washdown applications common in the food and beverage industry. Meanwhile, PUR cables are resistant to cutting fluids, oil, and other harsh chemicals. They also feature high tensile strength, abrasion resistance, and flexibility, making them ideal for high-frequency movement applications like robotic arms.

Dinkle's M5 panel-mounted circular connectors are equipped with sealing rings during installation, enabling high airtightness and waterproof performance. They are well-suited for harsh industrial automation environments. Structurally, Dinkle offers panel-mounted products with two installation options: front-mount and rear-mount designs.

Additionally, Dinkle provides M5 one-piece PCB circular connectors, where the housing and internal structure are integrated. This simplifies the installation process while enhancing connection stability and structural integrity. They are particularly suitable for industrial automation and miniature electronic equipment applications.

The M5 circular connectors include A-Code encoding, making them ideal for data and signal transmission in automation control systems. They are available in 3-pin and 4-pin options, offering flexible solutions for your equipment requirements.





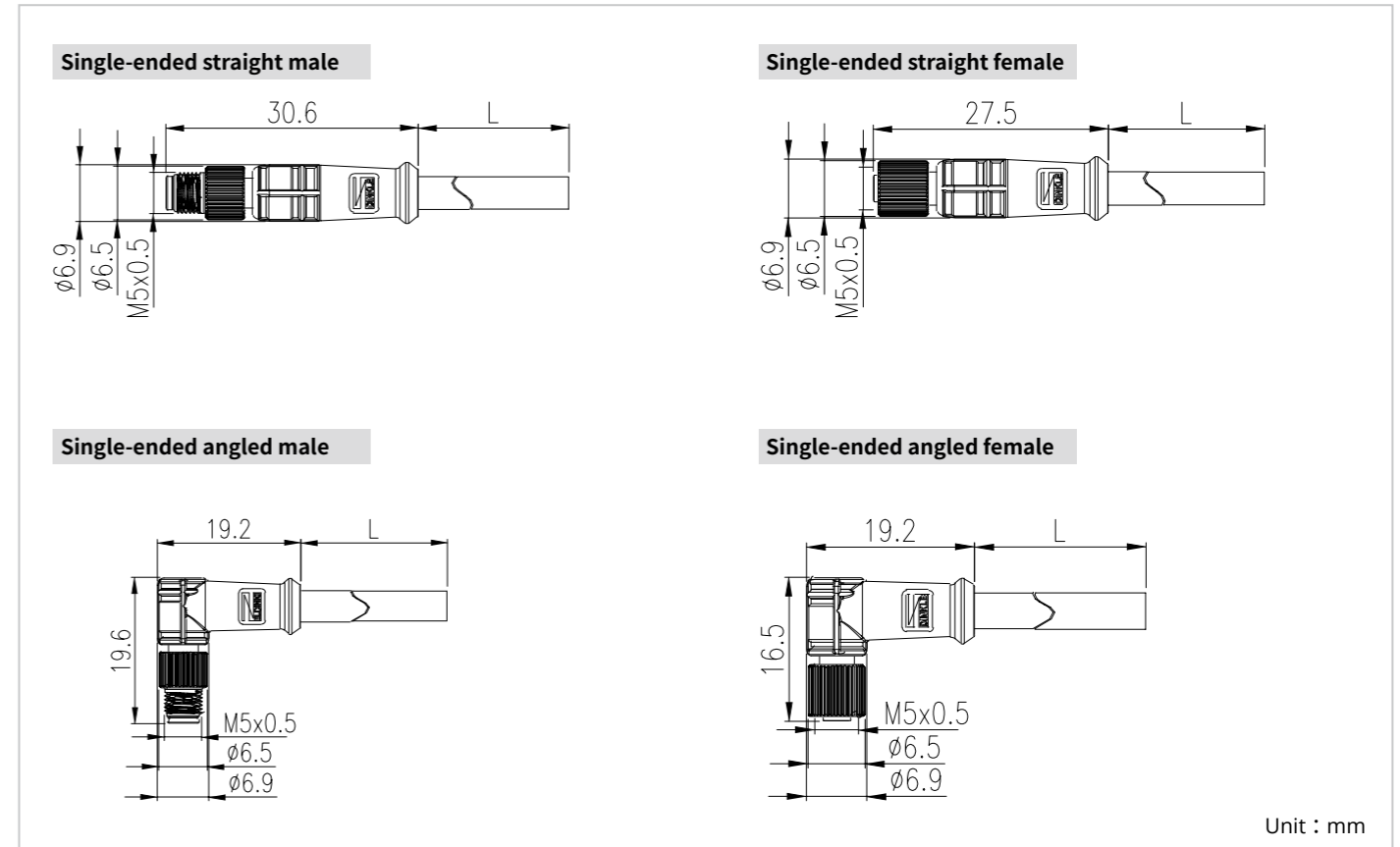

## M5 A-Code Molded Circular Connector

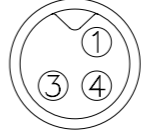
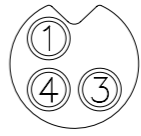
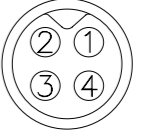
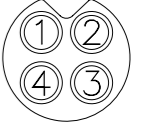

## M5 A-Code Molded Connector

Mechanical Properties		Material Properties	
Min. Insertion/withdrawal cycles	100	Contact / contact surface	Copper alloy / Gold plated
Degree of protection	IP67	Contact carrier / overmolding	PUR
Operating Temperature	-40°C ~ 80°C ( Fixed installation )	O-ring	NBR
	-25°C ~ 80°C ( Fixed installation )	Cable gland material	Copper alloy, nickel-plated
Fasten torque	0.3 Nm	UL94 Flammability rating	HB
Electrical Properties		Cable Information	
Rated voltage / current (contacts)	60VDC / 1A (3 Pin)	Cable Jacket	PUR / PVC, BLACK
	60VDC / 1A (4 Pin)	UL AWM style	Shield PUR : UL AWM 20549 / PVC : UL AWM 2464
Rated Impulse Voltage	1.5kV (3 Pin)		No Shield PUR : UL AWM 20549 / PVC : UL AWM 2464
	1.5kV (4 Pin)	Conductor cross section	0.14mm <sup>2</sup> / 26AWG (3 Pin)
Insulation resistance	Min. 100MΩ		0.14mm <sup>2</sup> / 26AWG (4 Pin)
Overvoltage Category	II	Material conductor insulation	PP
Pollution Degree	3	Flame resistance	FT-2 / VW-1
		Dielectric strength	2.0KV/1min
Standards and Regulations			
Design reference	IEC 61076-2-105: Detail specification for M5 connectors with screw-locking		
	IEC 60512: Electromechanical components for electronic equipment; basic testing procedure and measuring methods		
	IEC 60529: Degree of protection provided by enclosures (IP Code)		
Certification reference	UL 2238		
Notice			
The mechanical and electrical data performance can be ensured when the connector pair is correctly locked and fasten by specified torque. If the connector is not locked and or exposed in th contaminated enviroment, the connector must be sealed by the protective cover. Also, the influences from conductor, cable or PCB assembly must be taken into consideration.			

## M5 A-Code Molded Connector ( No Shield )

Coding and contacts	Code Contact	A		A	
		3		4	
Rated voltage / current		60V / 1A		60V / 1A	
Contact arrangement		Male	Female	Male	Female
					
Connector style	Cable	Length(m)	Part number		
	PVC	2	101-A3010-20S020	101-A4010-20S020	
		5	101-A3010-20S050	101-A4010-20S050	
		10	101-A3010-20S100	101-A4010-20S100	
	PUR	2	101-A3010-00S020	101-A4010-00S020	
		5	101-A3010-00S050	101-A4010-00S050	
		10	101-A3010-00S100	101-A4010-00S100	
	PVC	2	102-A3010-20S020	102-A4010-20S020	
		5	102-A3010-20S050	102-A4010-20S050	
		10	102-A3010-20S100	102-A4010-20S100	
	PUR	2	102-A3010-00S020	102-A4010-00S020	
		5	102-A3010-00S050	102-A4010-00S050	
		10	102-A3010-00S100	102-A4010-00S100	
	PVC	2	103-A3010-20S020	103-A4010-20S020	
		5	103-A3010-20S050	103-A4010-20S050	
		10	103-A3010-20S100	103-A4010-20S100	
	PUR	2	103-A3010-00S020	103-A4010-00S020	
		5	103-A3010-00S050	103-A4010-00S050	
		10	103-A3010-00S100	103-A4010-00S100	
	PVC	2	104-A3010-20S020	104-A4010-20S020	
		5	104-A3010-20S050	104-A4010-20S050	
		10	104-A3010-20S100	104-A4010-20S100	
	PUR	2	104-A3010-00S020	104-A4010-00S020	
		5	104-A3010-00S050	104-A4010-00S050	
		10	104-A3010-00S100	104-A4010-00S100	

## M5 A-Code Device Circular Connector

### Front mounting with 0.5m wire

Male

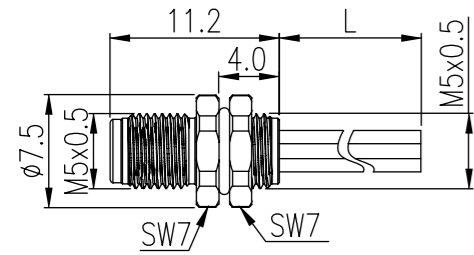

Female

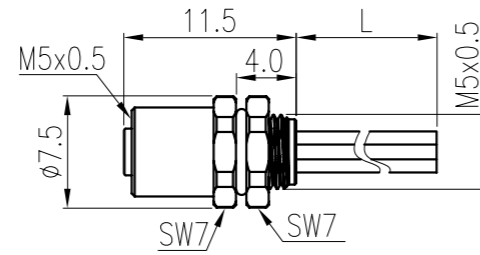

### Rear mounting with 0.5m wire

Male

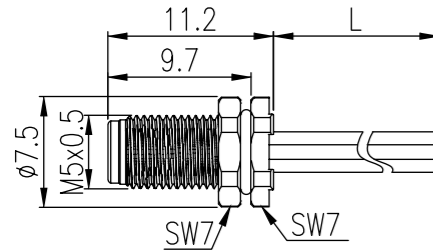

Female

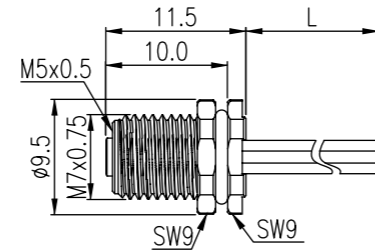

### Pin assignments and wire colors

Pin out	3P		4P	
	1	2	1	2
	Brown	-	Brown	White
	Blue		Blue	
	Black		Black	





## M5 A-Code Device Connector

Mechanical Properties		Material Properties	
Min. Insertion/withdrawal cycles	100	Contact / contact surface	Copper alloy / Gold plated
Degree of protection	IP67	Contact carrier	PA
Operating Temperature	-40°C ~ 80°C	Hexigonal nut / Outer Shield	Copper alloy, nickel-plated
Fasten torque	0.3 N·m	O-ring	NBR
Mounting torque	0.6 N·m	UL94 Flammability rating	V0
Electrical Properties		Cable Information	
Rated voltage / current (contacts)	60VDC / 1A (3 Pin)	Cable Jacket	PVC
	60VDC / 1A (4 Pin)	UL AWM style	PVC : UL 1061
Rated Impulse Voltage	1.5kV (3 Pin)	Conductor cross section	0.14mm <sup>2</sup> / 26AWG (3 Pin)
	1.5kV (4 Pin)		0.14mm <sup>2</sup> / 26AWG (4 Pin)
Insulation resistance	Min. 100MΩ	Material conductor insulation	PVC
Overvoltage Category	II	Flame resistance	FT-2 / VW-1
Pollution Degree	3	Dielectric strength	NA
Standards and Regulations			
Design reference	IEC 61076-2-105: Detail specification for M5 connectors with screw-locking		
	IEC 60512: Electromechanical components for electronic equipment; basic testing procedure and measuring methods		
	IEC 60529: Degree of protection provided by enclosures (IP Code)		
Certification reference	UL 2238		

### Notice

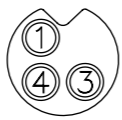
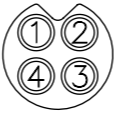
The mechanical and electrical data performance can be ensured when the connector pair is correctly locked and fasten by specified torque. If the connector is not locked and or exposed in th contaminated enviroment, the connector must be sealed by the protective cover. Also, the influences from conductor, cable or PCB assembly must be taken into consideration.

## M5 A-Code Device Connector ( No Shield )

Coding and contacts	Code	A		A	
	Contact	3		4	
Rated voltage / current		60V / 1A		60V / 1A	
Contact arrangement	Male				
	Female				
<b>Front mounting with 0.5m conductor</b>					
Connector style	Mount thread	Part number			
Male 	M5 X 0.5	118-A3010-0VSL50		118-A4010-0VSL50	
Female 	M5 X 0.5	119-A3010-0VSL50		119-A4010-0VSL50	
<b>Rear mounting with 0.5m conductor</b>					
Connector style	Mount thread	Part number			
Male 	M5 X 0.5	120-A3010-0VSL50		120-A4010-0VSL50	
Female 	M7 X 0.75	121-A3011-0VSL50		121-A4011-0VSL50	

The wire length can be customized. For more details, please contact Dinkle

## M5 A-Code One-piece PCB Circular Connector

### 180° Rear mounting, straight(NonShielded)

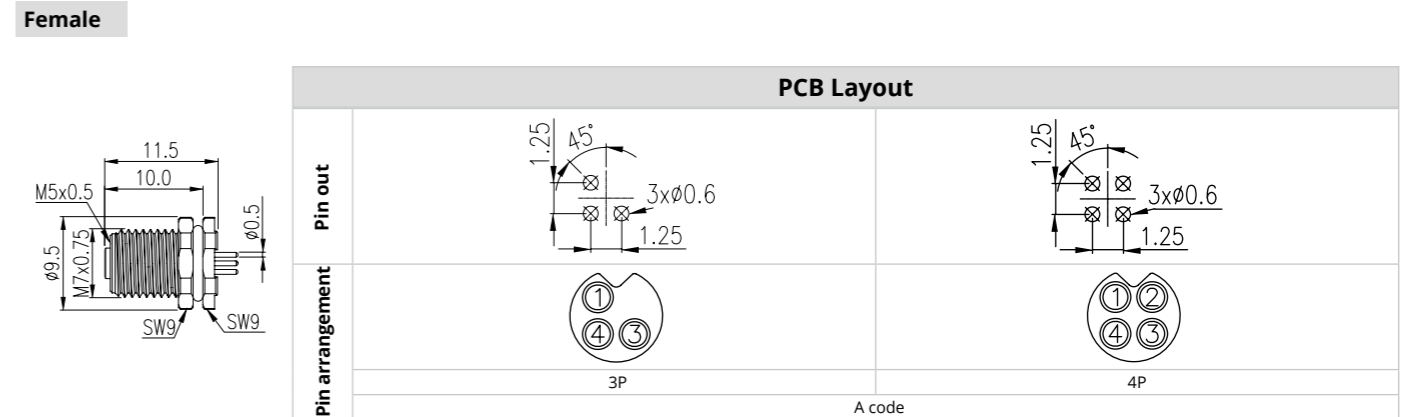
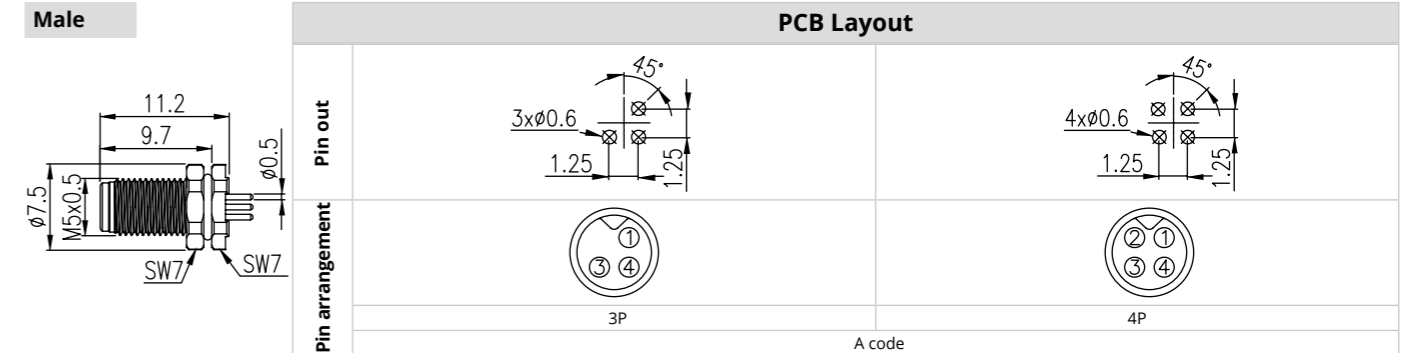

## M5 A-Code One-piece PCB Connector

Mechanical Properties		Material Properties	
Min. Insertion/withdrawal cycles	100	Contact / contact surface	Copper alloy / Gold plated
Degree of protection	IP67	Contact carrier	PA
Operating Temperature	-40°C ~ 80°C	Hexigonal nut / Outer Shield	Copper alloy, nickel-plated
Fasten torque	0.3 Nm	O-ring	NBR
Soldering method	Wave Soldering	UL94 Flammability rating	V0





Electrical Properties		Cable Information	
Rated voltage / current (contacts)	60VDC / 1A (3 Pin)		
	60VDC / 1A (4 Pin)		
Rated Impulse Voltage	1.5kV (3 Pin)		
	1.5kV (4 Pin)		
Insulation resistance	Min. 100M $\Omega$		
Overvoltage Category	II		
Pollution Degree	3		

Standards and Regulations	
Design reference	IEC 61076-2-105: Detail specification for M5 connectors with screw-locking IEC 60512: Electromechanical components for electronic equipment; basic testing procedure and measuring methods IEC 60529: Degree of protection provided by enclosures (IP Code)
Certification reference	UL 2238

### Notice

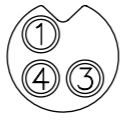
The mechanical and electrical data performance can be ensured when the connector pair is correctly locked and fasten by specified torque. If the connector is not locked and or exposed in th contaminated enviroment, the connector must be sealed by the protective cover. Also, the influences from conductor, cable or PCB assembly must be taken into consideration.

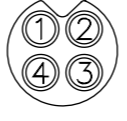
## M5 A-Code One-piece PCB Connector ( No Shield )

Coding and contacts	Code	A		A	
	Contact	3		4	
Rated voltage / current		60V / 1A		60V / 1A	
Contact arrangement	Male		Female	Male	Female
					
Rear mounting, straight					
Connector style	Mount thread	Part number			
Male 	M5 X 0.5	126-A3010-1	126-A4010-1		
Female 	M7 X 0.75	127-A3011-1	127-A4011-1		

# M8 Circular Connector

Dinkle's M8 circular connectors with cables combine miniaturization, high protection, durability, and ease of installation, making them ideal for industrial automation, sensor, and control system applications. Their corrosion-resistant materials and various coding options allow for stable operation and high-quality signal transmission in harsh industrial environments. To meet the needs of different industrial applications, Dinkle offers high-quality PVC and PUR cables. Additionally, shielded cables with tinned copper wire braiding are available, enhancing electromagnetic shielding and noise resistance, effectively preventing interference in high-noise environments, and ensuring the communication reliability of sensors and actuators.

If you require a more compact solution with higher power density within a limited enclosure space, Dinkle's M8 panel-mounted circular connectors perform excellently under demanding conditions and provide a minimum IP65 dustproof and waterproof rating. Structurally, the panel-mounted product line offers front-locking and rear-locking housings to accommodate different installation requirements. These connectors also include terminals with solder cups, allowing customers to customize wiring based on the internal space of their equipment.

Dinkle's M8 one-piece PCB circular connectors feature industry-standard metric thread structures and IP68 high protection ratings, enabling simple and secure direct transmission of signals, data, and power to PCBs. Whether it's M5, M8, or M12 PCB circular connectors, all use corrosion-resistant nickel-plated metal housings combined with sealing rings, offering the most reliable protection for your equipment.

The M8 two-piece PCB circular connectors employ SMT (Surface-Mount Technology), distinguishing them from earlier through-hole parts that used wave soldering. SMT significantly reduces the size of electronic products, achieving lighter, thinner, shorter, and more compact designs. SMT technology also boasts high reliability, strong vibration resistance, low solder joint defect rates, good high-frequency characteristics, high assembly density, small electronic product sizes, and ease of automation.

Dinkle's M8 circular connector series also includes A and B coding options, providing greater flexibility for your equipment solutions.



## M8 A-Code Molded Circular Connector

Single-ended straight male

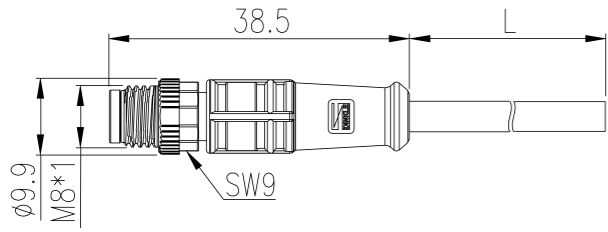

Single-ended straight female

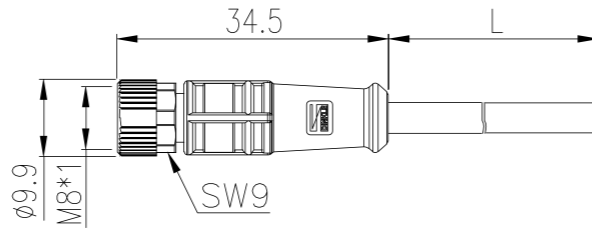

Single-ended angled male

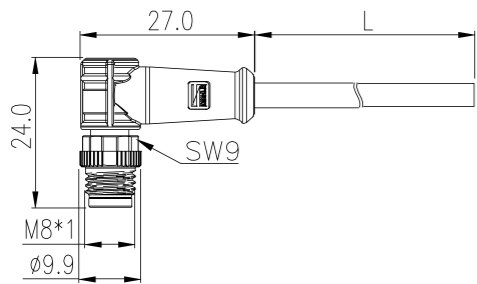

Single-ended angled female

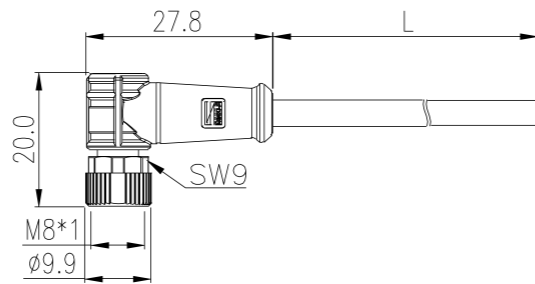

Unit : mm

Single male to Single female

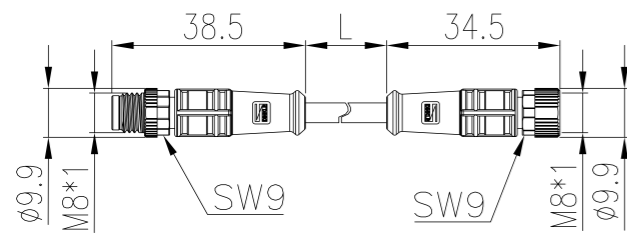

Angled male to angled female

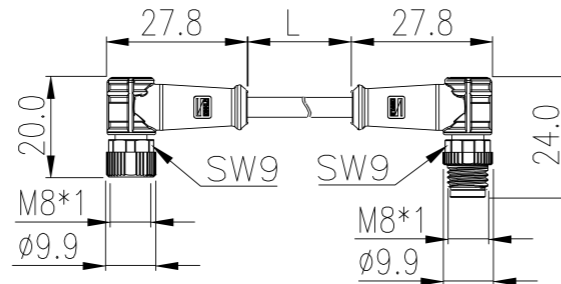

Single male to angled female

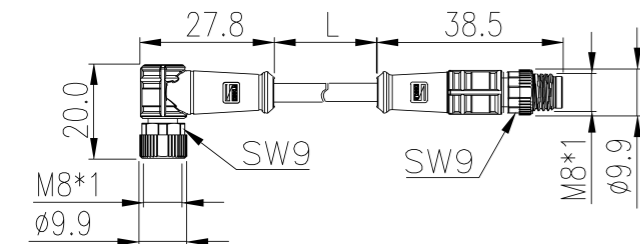

Angled male to straight female

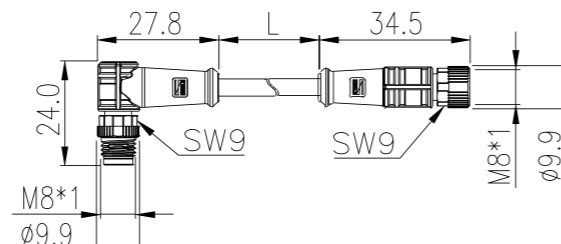

Unit : mm







## M8 A-Code Molded Connector

Mechanical Properties		Material Properties	
Min. Insertion/withdrawal cycles	100	Contact / contact surface	Copper alloy / Gold plated
Degree of protection	IP67	Contact carrier / overmolding	PUR / PUR
Operating Temperature	-40°C ~ 80°C ( Fixed installation )	O-ring	NBR
	-25°C ~ 80°C ( Fixed installation )	Cable gland material	Zinc die-cast, nickel-plated
Fasten torque	0.3 Nm	UL94 Flammability rating	HB
Electrical Properties		Cable Information	
Rated voltage / current (contacts)	60VAC / 4A (≤4 Pin)	Cable Jacket	PUR / PVC, BLACK
	30VAC / 1.5A (6 Pin)	UL AWM style	Shield PUR : UL AWM 20549 / PVC : UL AWM 2464
	30VAC / 1.5A (8 Pin)		No Shield PUR : UL AWM 20549 / PVC : UL AWM 2464
Rated Impulse Voltage	1.5kV (≤4 Pin)	Conductor cross section	0.20mm <sup>2</sup> / 24AWG (≤4 Pin)
	0.8kV (6 Pin)		0.14mm <sup>2</sup> / 26AWG (6 Pin)
	0.8kV (8 Pin)		0.14mm <sup>2</sup> / 26AWG (8 Pin)
Insulation resistance	Min. 100MΩ	Material conductor insulation	PP
Overvoltage Category	II	Flame resistance	FT-2 / VW-1
Pollution Degree	3	Dielectric strength	2.0KV/1min
Standards and Regulations			
Design reference	IEC 61076-2-104: Detail specification for M8 connectors with screw-locking		
	IEC 60512: Electromechanical components for electronic equipment; basic testing procedure and measuring methods		
	IEC 60529: Degree of protection provided by enclosures (IP Code)		
Certification reference	UL 2238		

### Notice







The mechanical and electrical data performance can be ensured when the connector pair is correctly locked and fasten by specified torque. If the connector is not locked and or exposed in th contaminated enviroment, the connector must be sealed by the protective cover. Also, the influences from conductor, cable or PCB assembly must be taken into consideration.

## M8 A-Code Molded Connector ( Shield )

Coding and contacts		Code	A		A		A		A	
		Contact	3	4	4	6	6	8	8	
Rated voltage / current			60V / 4A		60V / 4A		30V / 1.5A		30V / 1.5A	
Contact arrangement			Male	Female	Male	Female	Male	Female	Male	Female
Connector style		Cable	Length(m)		Part number					
	PVC	2	351-A3000-15S020	351-A4000-15S020	351-A6000-15S020	351-A8000-15S020				
		5	351-A3000-15S050	351-A4000-15S050	351-A6000-15S050	351-A8000-15S050				
		10	351-A3000-15S100	351-A4000-15S100	351-A6000-15S100	351-A8000-15S100				
	PUR	2	351-A3000-05S020	351-A4000-05S020	351-A6000-05S020	351-A8000-05S020				
		5	351-A3000-05S050	351-A4000-05S050	351-A6000-05S050	351-A8000-05S050				
		10	351-A3000-05S100	351-A4000-05S100	351-A6000-05S100	351-A8000-05S100				
	PVC	2	352-A3000-15S020	352-A4000-15S020	352-A6000-15S020	352-A8000-15S020				
		5	352-A3000-15S050	352-A4000-15S050	352-A6000-15S050	352-A8000-15S050				
		10	352-A3000-15S100	352-A4000-15S100	352-A6000-15S100	352-A8000-15S100				
	PUR	2	352-A3000-05S020	352-A4000-05S020	352-A6000-05S020	352-A8000-05S020				
		5	352-A3000-05S050	352-A4000-05S050	352-A6000-05S050	352-A8000-05S050				
		10	352-A3000-05S100	352-A4000-05S100	352-A6000-05S100	352-A8000-05S100				
	PVC	2	353-A3000-15S020	353-A4000-15S020	353-A6000-15S020	353-A8000-15S020				
		5	353-A3000-15S050	353-A4000-15S050	353-A6000-15S050	353-A8000-15S050				
		10	353-A3000-15S100	353-A4000-15S100	353-A6000-15S100	353-A8000-15S100				
	PUR	2	353-A3000-05S020	353-A4000-05S020	353-A6000-05S020	353-A8000-05S020				
		5	353-A3000-05S050	353-A4000-05S050	353-A6000-05S050	353-A8000-05S050				
		10	353-A3000-05S100	353-A4000-05S100	353-A6000-05S100	353-A8000-05S100				
	PVC	2	354-A3000-15S020	354-A4000-15S020	354-A6000-15S020	354-A8000-15S020				
		5	354-A3000-15S050	354-A4000-15S050	354-A6000-15S050	354-A8000-15S050				
		10	354-A3000-15S100	354-A4000-15S100	354-A6000-15S100	354-A8000-15S100				
	PUR	2	354-A3000-05S020	354-A4000-05S020	354-A6000-05S020	354-A8000-05S020				
		5	354-A3000-05S050	354-A4000-05S050	354-A6000-05S050	354-A8000-05S050				
		10	354-A3000-05S100	354-A4000-05S100	354-A6000-05S100	354-A8000-05S100				
	PVC	0.6	356-A3000-15SL60	356-A4000-15SL60	356-A6000-15SL60	356-A8000-15SL60				
		1.5	356-A3000-15S015	356-A4000-15S015	356-A6000-15S015	356-A8000-15S015				
		3	356-A3000-15S030	356-A4000-15S030	356-A6000-15S030	356-A8000-15S030				
	PUR	0.6	356-A3000-05SL60	356-A4000-05SL60	356-A6000-05SL60	356-A8000-05SL60				
		1.5	356-A3000-05S015	356-A4000-05S015	356-A6000-05S015	356-A8000-05S015				
		3	356-A3000-05S030	356-A4000-05S030	356-A6000-05S030	356-A8000-05S030				
	PVC	0.6	359-A3000-15SL60	359-A4000-15SL60	359-A6000-15SL60	359-A8000-15SL60				
		1.5	359-A3000-15S015	359-A4000-15S015	359-A6000-15S015	359-A8000-15S015				
		3	359-A3000-15S030	359-A4000-15S030	359-A6000-15S030	359-A8000-15S030				
	PUR	0.6	359-A3000-05SL60	359-A4000-05SL60	359-A6000-05SL60	359-A8000-05SL60				
		1.5	359-A3000-05S015	359-A4000-05S015	359-A6000-05S015	359-A8000-05S015				
		3	359-A3000-05S030	359-A4000-05S030	359-A6000-05S030	359-A8000-05S030				







The configuration of connectors and the cable length can be customized. For more details, please contact Dinkle

## M8 A-Code Molded Connector ( No Shield )

Coding and contacts		Code	A		A		A		A	
		Contact	3	4	4	6	6	8	8	
Rated voltage / current			60V / 4A		60V / 4A		30V / 1.5A		30V / 1.5A	
Contact arrangement			Male	Female	Male	Female	Male	Female	Male	Female
Connector style		Cable	Length(m)		Part number					
	PVC	2	<b>301-A3000-10S020</b>	<b>301-A4000-10S020</b>	301-A6000-10S020	<b>301-A8000-10S020</b>				
		5	<b>301-A3000-10S050</b>	<b>301-A4000-10S050</b>	301-A6000-10S050	<b>301-A8000-10S050</b>				
		10	<b>301-A3000-10S100</b>	<b>301-A4000-10S100</b>	301-A6000-10S100	<b>301-A8000-10S100</b>				
	PUR	2	<b>301-A3000-00S020</b>	<b>301-A4000-00S020</b>	301-A6000-00S020	<b>301-A8000-00S020</b>				
		5	<b>301-A3000-00S050</b>	<b>301-A4000-00S050</b>	301-A6000-00S050	<b>301-A8000-00S050</b>				
		10	<b>301-A3000-00S100</b>	<b>301-A4000-00S100</b>	301-A6000-00S100	<b>301-A8000-00S100</b>				
	PVC	2	<b>302-A3000-10S020</b>	<b>302-A4000-10S020</b>	302-A6000-10S020	<b>302-A8000-10S020</b>				
		5	<b>302-A3000-10S050</b>	<b>302-A4000-10S050</b>	302-A6000-10S050	<b>302-A8000-10S050</b>				
		10	<b>302-A3000-10S100</b>	<b>302-A4000-10S100</b>	302-A6000-10S100	<b>302-A8000-10S100</b>				
	PUR	2	<b>302-A3000-00S020</b>	<b>302-A4000-00S020</b>	302-A6000-00S020	<b>302-A8000-00S020</b>				
		5	<b>302-A3000-00S050</b>	<b>302-A4000-00S050</b>	302-A6000-00S050	<b>302-A8000-00S050</b>				
		10	<b>302-A3000-00S100</b>	<b>302-A4000-00S100</b>	302-A6000-00S100	<b>302-A8000-00S100</b>				
	PVC	2	<b>303-A3000-10S020</b>	<b>303-A4000-10S020</b>	303-A6000-10S020	<b>303-A8000-10S020</b>				
		5	<b>303-A3000-10S050</b>	<b>303-A4000-10S050</b>	303-A6000-10S050	<b>303-A8000-10S050</b>				
		10	<b>303-A3000-10S100</b>	<b>303-A4000-10S100</b>	303-A6000-10S100	<b>303-A8000-10S100</b>				
	PUR	2	<b>303-A3000-00S020</b>	<b>303-A4000-00S020</b>	303-A6000-00S020	<b>303-A8000-00S020</b>				
		5	<b>303-A3000-00S050</b>	<b>303-A4000-00S050</b>	303-A6000-00S050	<b>303-A8000-00S050</b>				
		10	<b>303-A3000-00S100</b>	<b>303-A4000-00S100</b>	303-A6000-00S100	<b>303-A8000-00S100</b>				
	PVC	2	<b>304-A3000-10S020</b>	<b>304-A4000-10S020</b>	304-A6000-10S020	<b>304-A8000-10S020</b>				
		5	<b>304-A3000-10S050</b>	<b>304-A4000-10S050</b>	304-A6000-10S050	<b>304-A8000-10S050</b>				
		10	<b>304-A3000-10S100</b>	<b>304-A4000-10S100</b>	304-A6000-10S100	<b>304-A8000-10S100</b>				
	PUR	2	<b>304-A3000-00S020</b>	<b>304-A4000-00S020</b>	304-A6000-00S020	<b>304-A8000-00S020</b>				
		5	<b>304-A3000-00S050</b>	<b>304-A4000-00S050</b>	304-A6000-00S050	<b>304-A8000-00S050</b>				
		10	<b>304-A3000-00S100</b>	<b>304-A4000-00S100</b>	304-A6000-00S100	<b>304-A8000-00S100</b>				
	PVC	0.6	<b>306-A3000-10SL60</b>	<b>306-A4000-10SL60</b>	306-A6000-10SL60	<b>306-A8000-10SL60</b>				
		1.5	<b>306-A3000-10S015</b>	<b>306-A4000-10S015</b>	306-A6000-10S015	<b>306-A8000-10S015</b>				
		3	<b>306-A3000-10S030</b>	<b>306-A4000-10S030</b>	306-A6000-10S030	<b>306-A8000-10S030</b>				
	PUR	0.6	<b>306-A3000-00SL60</b>	<b>306-A4000-00SL60</b>	306-A6000-00SL60	<b>306-A8000-00SL60</b>				
		1.5	<b>306-A3000-00S015</b>	<b>306-A4000-00S015</b>	306-A6000-00S015	<b>306-A8000-00S015</b>				
		3	<b>306-A3000-00S030</b>	<b>306-A4000-00S030</b>	306-A6000-00S030	<b>306-A8000-00S030</b>				
	PVC	0.6	<b>309-A3000-10SL60</b>	<b>309-A4000-10SL60</b>	309-A6000-10SL60	<b>309-A8000-10SL60</b>				
		1.5	<b>309-A3000-10S015</b>	<b>309-A4000-10S015</b>	309-A6000-10S015	<b>309-A8000-10S015</b>				
		3	<b>309-A3000-10S030</b>	<b>309-A4000-10S030</b>	309-A6000-10S030	<b>309-A8000-10S030</b>				
	PUR	0.6	<b>309-A3000-00SL60</b>	<b>309-A4000-00SL60</b>	309-A6000-00SL60	<b>309-A8000-00SL60</b>				
		1.5	<b>309-A3000-00S015</b>	<b>309-A4000-00S015</b>	309-A6000-00S015	<b>309-A8000-00S015</b>				
		3	<b>309-A3000-00S030</b>	<b>309-A4000-00S030</b>	309-A6000-00S030	<b>309-A8000-00S030</b>				



The configuration of connectors and the cable length can be customized. For more details, please contact Dinkle

## M8 A-Code Molded Connector ( No Shield, Drag, chain )

Coding and contacts		Code Contact	A 3		A 4		A 6		A 8	
Rated voltage / current			60V / 4A		60V / 4A		30V / 1.5A		30V / 1.5A	
Contact arrangement			Male	Female	Male	Female	Male	Female	Male	Female
Connector style	Cable	Length(m)	Part number							
 Single-ended straight male	PUR	2	301-A3000-02S020	301-A4000-02S020	301-A6000-02S020	301-A8000-02S020				
		5	301-A3000-02S050	301-A4000-02S050	301-A6000-02S050	301-A8000-02S050				
		10	301-A3000-02S100	301-A4000-02S100	301-A6000-02S100	301-A8000-02S100				
 Single-ended straight female	PUR	2	302-A3000-02S020	302-A4000-02S020	302-A6000-02S020	302-A8000-02S020				
		5	302-A3000-02S050	302-A4000-02S050	302-A6000-02S050	302-A8000-02S050				
		10	302-A3000-02S100	302-A4000-02S100	302-A6000-02S100	302-A8000-02S100				
 Single-ended angled male	PUR	2	303-A3000-02S020	303-A4000-02S020	303-A6000-02S020	303-A8000-02S020				
		5	303-A3000-02S050	303-A4000-02S050	303-A6000-02S050	303-A8000-02S050				
		10	303-A3000-02S100	303-A4000-02S100	303-A6000-02S100	303-A8000-02S100				
 Single-ended angled female	PUR	2	304-A3000-02S020	304-A4000-02S020	304-A6000-02S020	304-A8000-02S020				
		5	304-A3000-02S050	304-A4000-02S050	304-A6000-02S050	304-A8000-02S050				
		10	304-A3000-02S100	304-A4000-02S100	304-A6000-02S100	304-A8000-02S100				
 Straight male mate straight female	PUR	0.6	306-A3000-02SL60	306-A4000-02SL60	306-A6000-02SL60	306-A8000-02SL60				
		1.5	306-A3000-02S015	306-A4000-02S015	306-A6000-02S015	306-A8000-02S015				
		3	306-A3000-02S030	306-A4000-02S030	306-A6000-02S030	306-A8000-02S030				
 Angled male mate angled female	PUR	0.6	309-A3000-02SL60	309-A4000-02SL60	309-A6000-02SL60	309-A8000-02SL60				
		1.5	309-A3000-02S015	309-A4000-02S015	309-A6000-02S015	309-A8000-02S015				
		3	309-A3000-02S030	309-A4000-02S030	309-A6000-02S030	309-A8000-02S030				



Cables with drag chain function are guaranteed to withstand 5 million bending times(R=28mm, L=1m, V=1m/s)  
The configuration of connectors and the cable length can be customized. For more details, please contact Dinkle

## M8 mate M12 A-Code Molded Connector ( Shielded )

Coding and contacts		Code Contact	A 3		A 4	
Rated voltage / current			60V / 4A		60V / 4A	
Contact arrangement			Male	Female	Male	Female
Connector style	Cable	Length(m)	Part number			
 M8 straight male mate M12 straight female	PVC	0.6	350-13000-10SL60		350-14000-10SL60	
		1.5	350-13000-10S015		350-14000-10S015	
		3	350-13000-10S030		350-14000-10S030	
	PUR	0.6	350-13000-00SL60		350-14000-00SL60	
		1.5	350-13000-00S015		350-14000-00S015	
		3	350-13000-00S030		350-14000-00S030	
 M8 angled male mate M12 angled female	PVC	0.6	350-73000-10SL60		350-74000-10SL60	
		1.5	350-73000-10S015		350-74000-10S015	
		3	350-73000-10S030		350-74000-10S030	
	PUR	0.6	350-73000-00SL60		350-74000-00SL60	
		1.5	350-73000-00S015		350-74000-00S015	
		3	350-73000-00S030		350-74000-00S030	

The connector on both sides can be customized, such as straight/angled, male/female  
The cable length can be customized, please contacts with Dinkle

## M8 mate M12 A-Code Molded Connector ( No Shielded )

Coding and contacts		Code Contact	A 3		A 4	
Rated voltage / current			60V / 4A		60V / 4A	
Contact arrangement			Male	Female	Male	Female
Connector style	Cable	Length(m)	Part number			
 M8 straight male mate M12 straight female	PUR	0.6	350-13000-02SL60		350-14000-02SL60	
		1.5	350-13000-02S015		350-14000-02S015	
		3	350-13000-02S030		350-14000-02S030	
 M8 angled male mate M12 angled female	PUR	0.6	350-73000-02SL60		350-74000-02SL60	
		1.5	350-73000-02S015		350-74000-02S015	
		3	350-73000-02S030		350-74000-02S030	

The connector on both sides can be customized, such as straight/angled, male/female  
The cable length can be customized, please contacts with Dinkle

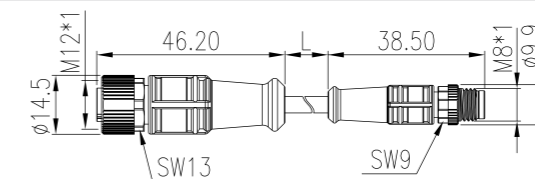

## M8 A-Code Device Circular Connector

### Front mounting with 0.5m wire

Male

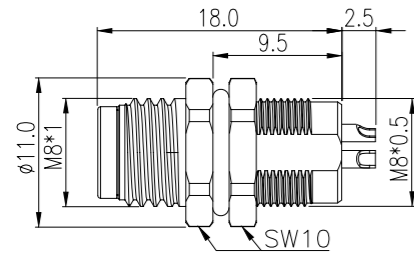

Female

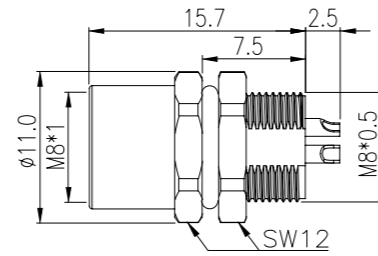

### Front mounting with solder cup

Male

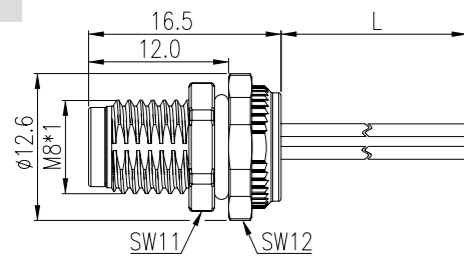

Female

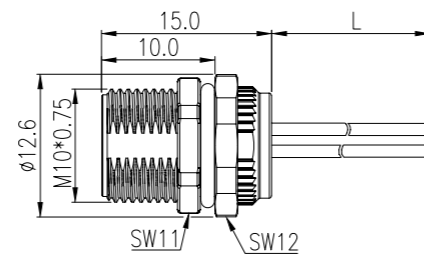

### Rear mounting with 0.5m wire

Male

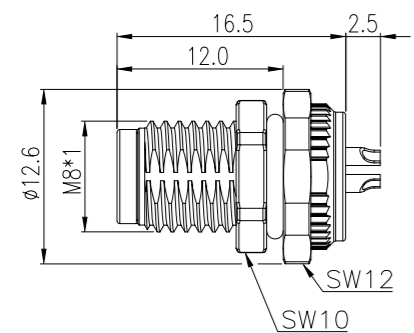

Female

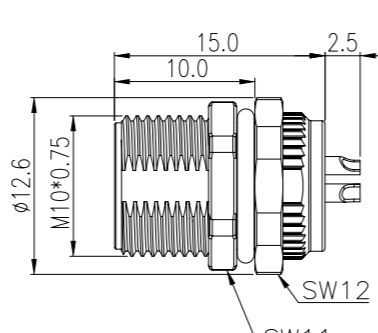

### Pin assignments and wire colors

Pin arrangement	A code					
	3P	4P	6P	8P		
Pin out	1	Brown	1	Brown	1	White
	2	-	2	White	2	Brown
	3	Blue	3	Blue	3	Green
	4	Black	4	Black	4	Yellow
			5	Gray	5	Gray
			6	Pink	6	Pink
					7	Blue
					8	Red

## M8 A-Code Device Connector

Mechanical Properties		Material Properties	
Min. Insertion/withdrawal cycles	100	Contact / contact surface	Copper alloy / Gold plated
Degree of protection	IP67	Contact carrier	PA
Operating Temperature	-40°C ~ 80°C	Hexagonal nut / Outer Shield	Zinc die-cast, nickel-plated
Fasten torque	0.3 Nm	O-ring	NBR
Mounting torque	0.8 Nm	UL94 Flammability rating	V0

Electrical Properties		Cable Information	
Rated voltage / current (contacts)	60VAC / 4A (≤4 Pin)	Cable Jacket	PVC
	30VAC / 1.5A (6 Pin)	UL AWM style	PVC : UL 1061
	30VAC / 1.5A (8 Pin)		0.25mm <sup>2</sup> / 24AWG (≤4 Pin)
Rated Impulse Voltage	1.5kV (≤4 Pin)	Conductor cross section	0.14mm <sup>2</sup> / 26AWG (6 Pin)
	0.8kV (6 Pin)		0.14mm <sup>2</sup> / 26AWG (8 Pin)
	0.8kV (8 Pin)	Material conductor insulation	SR-PVC
Insulation resistance	Min. 100MΩ	Flame resistance	VW-1/FT-1
Overvoltage Category	II	Dielectric strength	NA
Pollution Degree	3		

Standards and Regulations	
Design reference	IEC 61076-2-104: Detail specification for M8 connectors with screw-locking IEC 60512: Electromechanical components for electronic equipment; basic testing procedure and measuring methods IEC 60529: Degree of protection provided by enclosures (IP Code)
Certification reference	UL 2238

Notice	
The mechanical and electrical data performance can be ensured when the connector pair is correctly locked and fasten by specified torque. If the connector is not locked and or exposed in th contaminated enviroment, the connector must be sealed by the protective cover. Also, the influences from conductor, cable or PCB assembly must be taken into consideration.	

## M8 A-Code Device Connector ( No Shield )

Coding and contacts	Code	A		A		A		A	
	Contact	3		4		6		8	
Rated voltage / current		60V / 4A		60V / 4A		30V / 1.5A		30V / 1.5A	
Contact arrangement	Male								
	Female								
<b>Front mounting with 0.5m wire</b>									
Connector style	Mount thread	Part number							
Male	M8 X 0.5	<b>318-A3000-0VSL50</b>	<b>318-A4000-0VSL50</b>	318-A6000-0VSL50	318-A8000-0VSL50				
Female	M8 X 0.5	<b>319-A3000-0VSL50</b>	<b>319-A4000-0VSL50</b>	319-A6000-0VSL50	319-A8000-0VSL50				
<b>Rear mounting with 0.5m wire</b>									
Connector style	Mount thread	Part number							
Male	M8 x 1	<b>320-A3001-0VSL50</b>	<b>320-A4001-0VSL50</b>	320-A6001-0VSL50	320-A8001-0VSL50				
Female	M10 x 0.75	<b>321-A3002-0VSL50</b>	<b>321-A4002-0VSL50</b>	321-A6002-0VSL50	321-A8002-0VSL50				
<b>Front mounting with solder cup</b>									
Connector style	Mount thread	Part number							
Male	M8 X 0.5	<b>332-A3000-S</b>	<b>332-A4000-S</b>	332-A6000-S	332-A8000-S				
Female	M8 X 0.5	<b>333-A3000-S</b>	<b>333-A4000-S</b>	333-A6000-S	333-A8000-S				
<b>Rear mounting with solder cup</b>									
Connector style	Mount thread	Part number							
Male	M8 x 1	<b>330-A3001-S</b>	<b>330-A4001-S</b>	330-A6001-S	330-A8001-S				
Female	M10 x 0.75	<b>331-A3002-S</b>	<b>331-A4002-S</b>	331-A6002-S	331-A8002-S				

**Bolded part number is cULus certified.**

The wire length can be customized. For more details, please contact Dinkle

## M8 A-Code One-piece PCB Circular Connector

### 180° Rear mounting, straight

Male

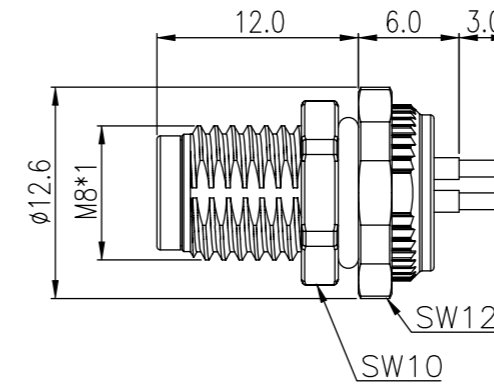

Female

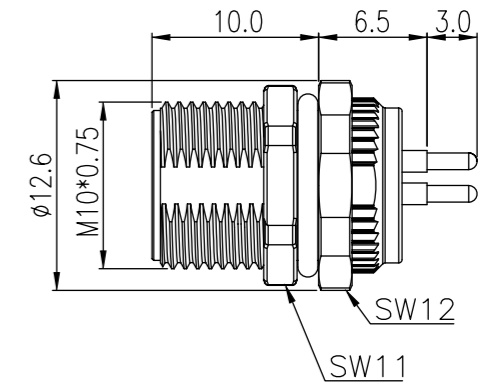

### PCB Layout

	3P	4P	6P	8P
Pin out				
Pin arrangement				
	3P	4P	6P	8P

A code

## M8 A-Code One-piece PCB Connector

Mechanical Properties		Material Properties	
Min. Insertion/withdrawal cycles	100	Contact / contact surface	Copper alloy / Gold plated
Degree of protection	IP67	Contact carrier	PA
Operating Temperature	-40°C ~ 80°C	Hexigonal nut / Outer Shield	Zinc die-cast, nickel-plated / Brass, nickel-plated
Fasten torque	0.4 Nm	O-ring	NBR
Soldering method	Wave Soldering	UL94 Flammability rating	V0
Electrical Properties		Cable Information	
Rated voltage / current (contacts)	60VAC / 4A (≤4 Pin)		
	30VAC / 1.5A (6 Pin)		
	30VAC / 1.5A (8 Pin)		
Rated Impulse Voltage	1.5kV (≤4 Pin)		
	0.8kV (6 Pin)		
	0.8kV (8 Pin)		
Insulation resistance	Min. 100MΩ		
Overvoltage Category	II		
Pollution Degree	3		
Standards and Regulations			
Design reference	IEC 61076-2-104: Detail specification for M8 connectors with screw-locking		
	IEC 60512: Electromechanical components for electronic equipment; basic testing procedure and measuring methods		
	IEC 60529: Degree of protection provided by enclosures (IP Code)		
Certification reference	UL 2238		
Notice			
The mechanical and electrical data performance can be ensured when the connector pair is correctly locked and fasten by specified torque. If the connector is not locked and or exposed in th contaminated enviroment, the connector must be sealed by the protective cover. Also, the influences from conductor, cable or PCB assembly must be taken into consideration.			

## M8 A-Code One-piece PCB Connector ( Shield / No Shield )

Coding and contacts	Code	A		A		A		A	
	Contact	3		4		6		8	
Rated voltage / current		60V / 4A		60V / 4A		30V / 1.5A		30V / 1.5A	
Contact arrangement		Male	Female	Male	Female	Male	Female	Male	Female
									
Rear mounting, straight, No shield									
Connector style	Mount thread	Part number							
Male 	M8 X 1	<b>326-A3001-4</b>	<b>326-A4001-4</b>	326-A6001-4		326-A8001-4			
Female 	M10 x 0.75	<b>327-A3002-4</b>	<b>327-A4002-4</b>	327-A6002-4		327-A8002-4			
Rear mounting, angled, shield									
Connector style	Mount thread	Part number							
Male 	M8 X 1	328-A3001-4	328-A4001-4	328-A6001-4		328-A8001-4			
Female 	M10 x 0.75	329-A3002-4	329-A4002-4	329-A6002-4		329-A8002-4			

**Bolded part number is cULus certified.**

## M8 A-Code Two-piece PCB Circular Connector

### 180° Rear mounting, straight (Shielded)

#### Male

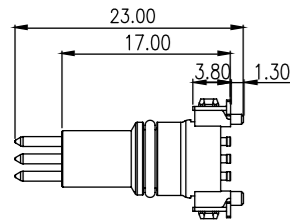

		PCB Layout				
Pin out						
Pin arrangement	3P	4P	5P	6P	8P	
A code						

#### Female

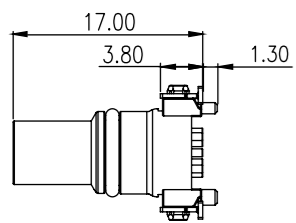

		PCB Layout				
Pin out						
Pin arrangement	3P	4P	5P	6P	8P	
A code						

## M8 A-Code Two-piece PCB Connector

Mechanical Properties		Material Properties	
Min. Insertion/withdrawal cycles	100	Contact / contact surface	Copper alloy / Gold plated
Degree of protection	IP67	Contact carrier	LCP
Operating Temperature	-25°C ~ 80°C	O-ring	SILICONE
Soldering method	THR	Moisture Sensitivity Levels	1
		UL94 Flammability rating	V0
電氣特性		線材資訊	
Rated voltage / current (contacts)	60VAC / 4A (≤4 Pin)		
	30VAC / 3A (5 Pin)		
	30VAC / 1.5A (6 Pin)		
	30VAC / 1.5A (8 Pin)		
Rated Impulse Voltage	1.5kV (≤4 Pin)		
	0.8kV (5 Pin)		
	0.8kV (6 Pin)		
	0.8kV (8 Pin)		
Insulation resistance	Min. 100MΩ		
Overvoltage Category	II		
Pollution Degree	3		
Standards and Regulations			
Design reference	IEC 61076-2-104: Detail specification for M8 connectors with screw-locking		
	IEC 60512: Electromechanical components for electronic equipment; basic testing procedure and measuring methods		
	IEC 60529: Degree of protection provided by enclosures (IP Code)		
Notice			
The mechanical and electrical data performance can be ensured when the connector pair is correctly locked and fasten by specified torque. If the connector is not locked and or exposed in th contaminated enviroment, the connector must be sealed by the protective cover. Also, the influences from conductor, cable or PCB assembly must be taken into consideration.			

## M8 A-Code Two-piece PCB Connector ( No Shield )

Coding and contacts	Code	A		A		A		A		A	
	Contact	3		4		5		6		8	
Rated voltage / current		60V / 4A		60V / 4A		60V / 4A		30V / 1.5A		30V / 1.5A	
Contact arrangement		Male	Female	Male	Female	Male	Female	Male	Female	Male	Female
SMT Soldering, straight, No shield											
Connector style	package	Part number									
 Male	Tray	381-A3S00U-1	381-A4S00U-1	-	-	-	-	-	-	-	-
	Tape-and reel	381-A3S00U-2	381-A4S00U-2	-	-	-	-	-	-	-	-
 Female	Tray	382-A3S00U-1	382-A4S00U-1	382-A5S00U-1	382-A6S00U-1	382-A8S00U-1					
	Tape-and reel	382-A3S00U-2	382-A4S00U-2	382-A5S00U-2	382-A6S00U-2	382-A8S00U-2					
Style	Mount thread	Part number									
 Male use	M12 X 1	383-S1200									
 Female use	M12 X 1	384-S1200									

Package unit, Tray : 60 pcs; Tape-and-Reel : 100 pcs

## M8 B-Code Molded Circular Connector

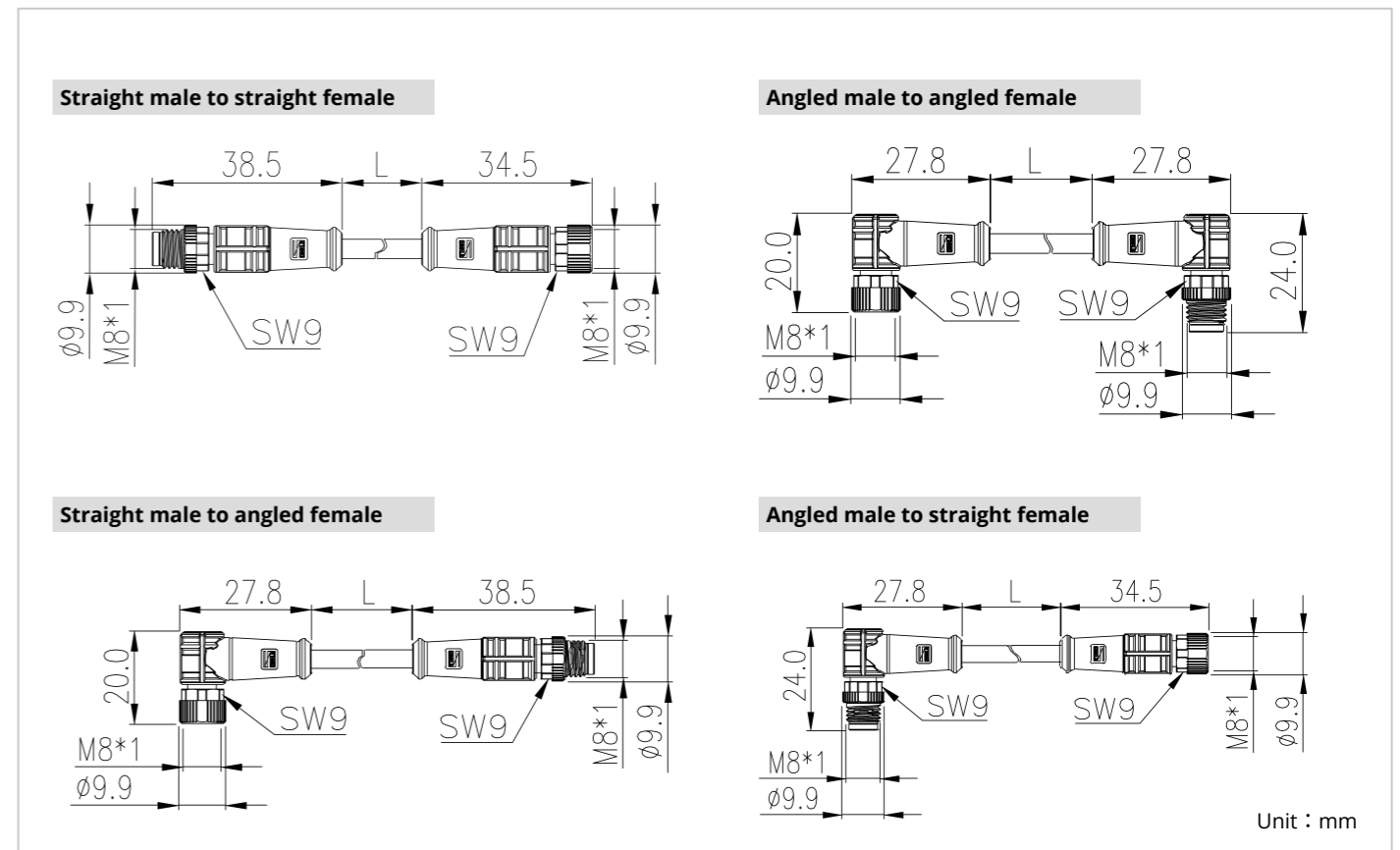
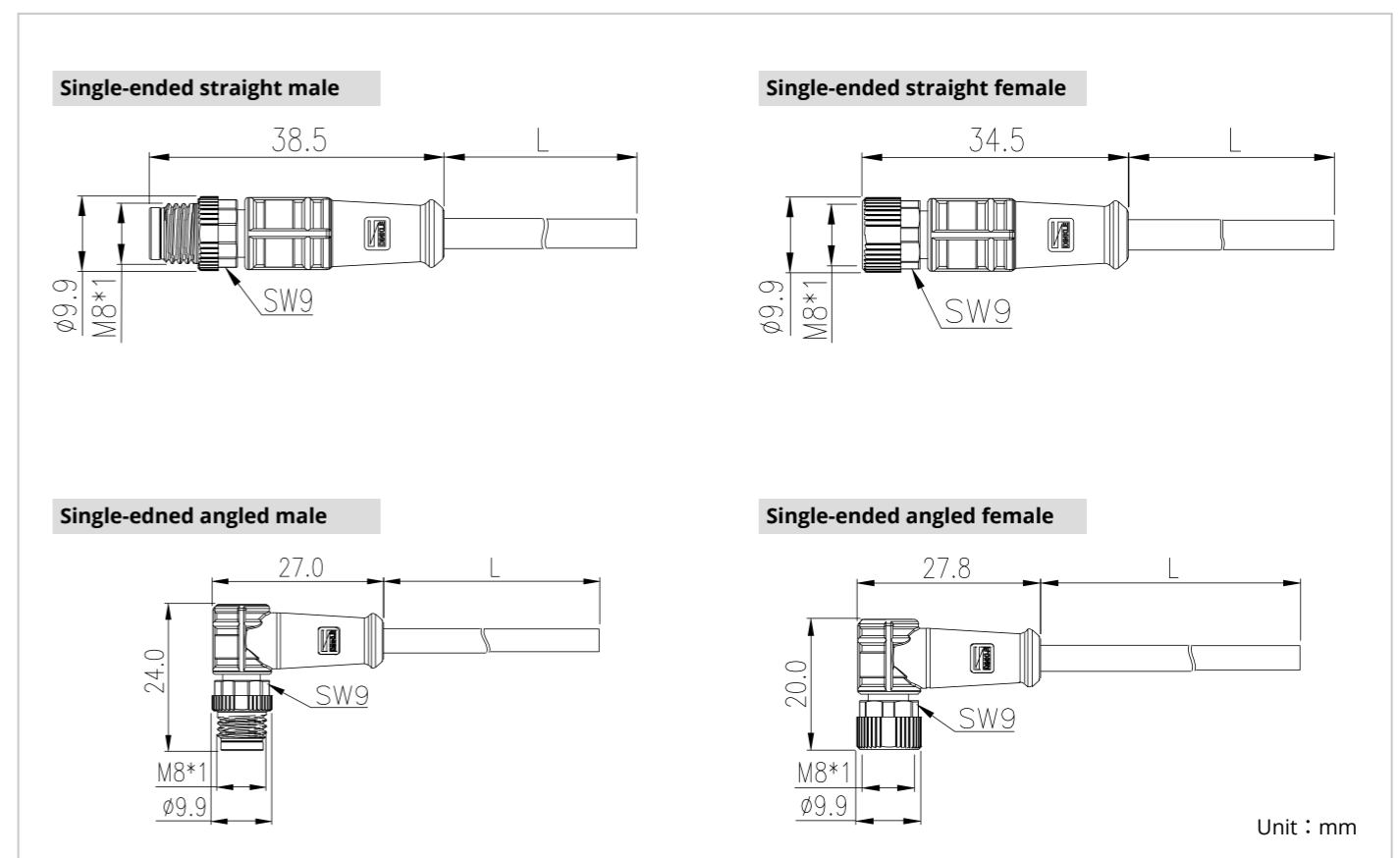

## M8 B-Code Molded Connector









Mechanical Properties		Material Properties	
Min. Insertion/withdrawal cycles	100	Contact / contact surface	Copper alloy / Gold plated
Degree of protection	IP67	Contact carrier / overmolding	PUR / PUR
Operating Temperature	-40°C ~ 80°C ( Fixed installation )	O-ring	NBR
	-25°C ~ 80°C ( Fixed installation )	Cable gland material	Zinc die-cast, nickel-plated
Fasten torque	0.3 Nm	UL94 Flammability rating	HB
Electrical Properties		Cable Information	
Rated voltage / current (contacts)	30VAC / 3A (5 Pin)	Cable Jacket	PUR / PVC, BLACK
Rated Impulse Voltage	0.8kV (5 Pin)	UL AWM style	Shield PUR : UL AWM 20549 / PVC : UL AWM 2464
Insulation resistance	Min. 100MΩ		No Shield PUR : UL AWM 20549 / PVC : UL AWM 2464
Overvoltage Category	II	Conductor cross section	0.20mm <sup>2</sup> / 24AWG (5 Pin)
Pollution Degree	3	Material conductor insulation	PP
		Flame resistance	FT-2 / VW-1
		Dielectric strength	2.0KV/1min
Standards and Regulations			
Design reference	IEC 61076-2-104: Detail specification for M8 connectors with screw-locking		
	IEC 60512: Electromechanical components for electronic equipment; basic testing procedure and measuring methods		
	IEC 60529: Degree of protection provided by enclosures (IP Code)		
Certification reference	UL 2238		
Notice			
The mechanical and electrical data performance can be ensured when the connector pair is correctly locked and fasten by specified torque. If the connector is not locked and or exposed in th contaminated enviroment, the connector must be sealed by the protective cover. Also, the influences from conductor, cable or PCB assembly must be taken into consideration.			

## M8 B-Code Molded Connector ( Shield )

Coding and contacts	Code	B	
	Contact	5	
Rated voltage / current		30V / 3A	
Contact arrangement		Male 	Female 
Connector style	Cable	Length(m)	Part number
Single-ended straight male 	PVC	2	351-B5000-15S020
		5	351-B5000-15S050
		10	351-B5000-15S100
	PUR	2	351-B5000-05S020
		5	351-B5000-05S050
		10	351-B5000-05S100
Single-ended straight female 	PVC	2	352-B5000-15S020
		5	352-B5000-15S050
		10	352-B5000-15S100
	PUR	2	352-B5000-05S020
		5	352-B5000-05S050
		10	352-B5000-05S100
Single-ended angled male 	PVC	2	353-B5000-15S020
		5	353-B5000-15S050
		10	353-B5000-15S100
	PUR	2	353-B5000-05S020
		5	353-B5000-05S050
		10	353-B5000-05S100
Single-ended angled female 	PVC	2	354-B5000-15S020
		5	354-B5000-15S050
		10	354-B5000-15S100
	PUR	2	354-B5000-05S020
		5	354-B5000-05S050
		10	354-B5000-05S100
Straight male mate straight female 	PVC	0.6	356-B5000-15SL60
		1.5	356-B5000-15S015
		3	356-B5000-15S030
	PUR	0.6	356-B5000-05SL60
		1.5	356-B5000-05S015
		3	356-B5000-05S030
Angled male mate angled female 	PVC	0.6	359-B5000-15SL60
		1.5	359-B5000-15S015
		3	359-B5000-15S030
	PUR	0.6	359-B5000-05SL60
		1.5	359-B5000-05S015
			359-B5000-05S030

The configuration of connectors and the cable length can be customized. For more details, please contact Dinkle

## M8 B-Code Molded Connector ( No Shield )

Coding and contacts		Code	B	
		Contact	5	
Rated voltage / current		30V / 3A		
Contact arrangement		Male	Female	
				
Connector style	Cable	Length(m)	Part number	
Single-ended straight male 	PVC	2	301-B5000-10S020	
		5	301-B5000-10S050	
		10	301-B5000-10S100	
	PUR	2	301-B5000-00S020	
		5	301-B5000-00S050	
		10	301-B5000-00S100	
Single-ended straight female 	PVC	2	302-B5000-10S020	
		5	302-B5000-10S050	
		10	302-B5000-10S100	
	PUR	2	302-B5000-00S020	
		5	302-B5000-00S050	
		10	302-B5000-00S100	
Single-ended angled male 	PVC	2	303-B5000-10S020	
		5	303-B5000-10S050	
		10	303-B5000-10S100	
	PUR	2	303-B5000-00S020	
		5	303-B5000-00S050	
		10	303-B5000-00S100	
Single-ended angled female 	PVC	2	304-B5000-10S020	
		5	304-B5000-10S050	
		10	304-B5000-10S100	
	PUR	2	304-B5000-00S020	
		5	304-B5000-00S050	
		10	304-B5000-00S100	
Straight male mate straight female 	PVC	0.6	306-B5000-10SL60	
		1.5	306-B5000-10S015	
		3	306-B5000-10S030	
	PUR	0.6	306-B5000-00SL60	
		1.5	306-B5000-00S015	
		3	306-B5000-00S030	
Angled male mate angled female 	PVC	0.6	309-B5000-10SL60	
		1.5	309-B5000-10S015	
		3	309-B5000-10S030	
	PUR	0.6	309-B5000-00SL60	
		1.5	309-B5000-00S015	
			309-B5000-00S030	

The configuration of connectors and the cable length can be customized. For more details, please contact Dinkle

## M8 B-Code Molded Connector ( No Shield, Drag, chain )

Coding and contacts		Code	B	
		Contact	5	
Rated voltage / current		30V / 3A		
Contact arrangement		Male	Female	
				
Connector style	Cable	Length(m)	Part number	
Single-ended straight male 	PUR	2	301-B5000-02S020	
		5	301-B5000-02S050	
		10	301-B5000-02S100	
Single-ended straight female 	PUR	2	302-B5000-02S020	
		5	302-B5000-02S050	
		10	302-B5000-02S100	
Single-ended angled male 	PUR	2	303-B5000-02S020	
		5	303-B5000-02S050	
		10	303-B5000-02S100	
Single-ended angled female 	PUR	2	304-B5000-02S020	
		5	304-B5000-02S050	
		10	304-B5000-02S100	
Straight male mate straight female 	PUR	0.6	306-B5000-02SL60	
		1.5	306-B5000-02S015	
		3	306-B5000-02S030	
Angled male mate angled female 	PUR	0.6	309-B5000-02SL60	
		1.5	309-B5000-02S015	
			309-B5000-02S030	

Cables with drag chain function are guaranteed to withstand 5 million bending times(R=28mm, L=1m, V=1m/s)  
The configuration of connectors and the cable length can be customized. For more details, please contact Dinkle

## M8 B-Code Device Circular Connector

### Front mounting with 0.5m wire

Male

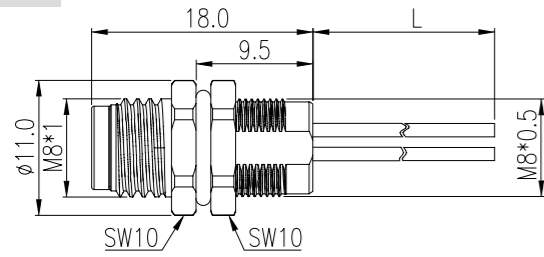

Female

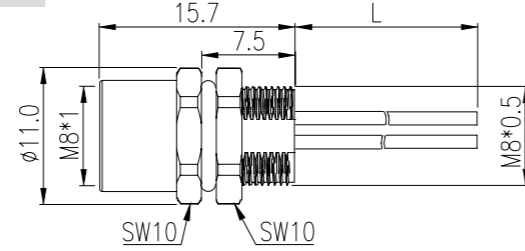

### Front mounting with solder cup

Male

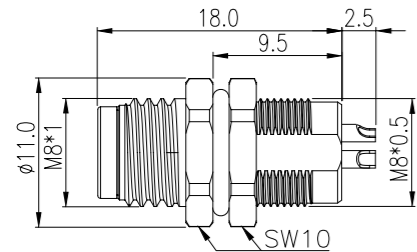

Female

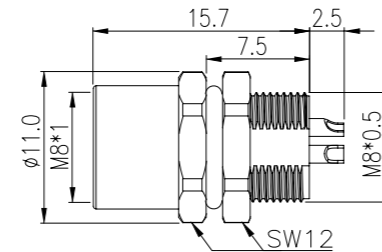

### Rear mounting with 0.5m wire

Male

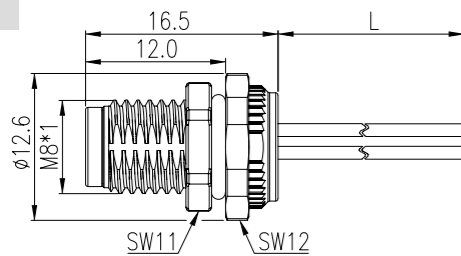

Female

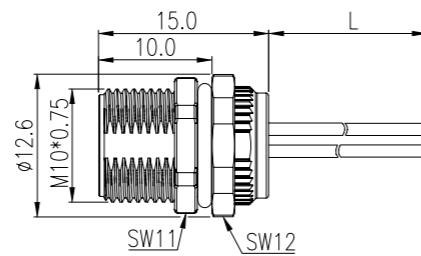

### Rear mounting with solder cup

Male

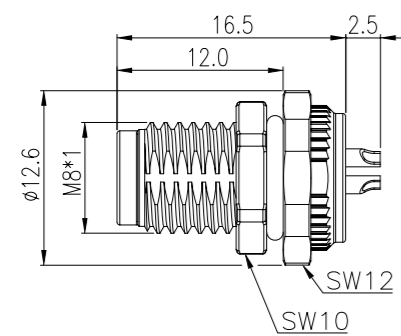

Female

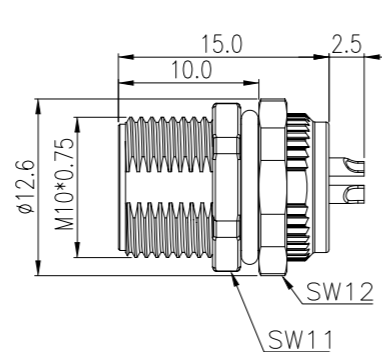

### Pin assignments and wire colors

Pin out	Pin arrangement	Wire color
	5P	
	B code	
1		Brown
2		White
3		Blue
4		Black
5		Gray

## M8 B-Code Device Connector

Mechanical Properties		Mechanical Properties	
Min. Insertion/withdrawal cycles	100	Contact / contact surface	Copper alloy / Gold plated
Degree of protection	IP67	Contact carrier	PA
Operating Temperature	-40°C ~ 80°C	Hexigonal nut / Outer Shield	Zinc die-cast, nickel-plated
Fasten torque	0.3 Nm	O-ring	NBR
Mounting torque	0.8 Nm	UL94 Flammability rating	V0

Electrical Properties		Cable Information	
Rated voltage / current (contacts)	30VAC / 3A (5 Pin)	Cable Jacket	PVC
Rated Impulse Voltage	0.8kV (5 Pin)	UL AWM style	PVC : UL 1061
Insulation resistance	Min. 100MΩ	Conductor cross section	0.25mm <sup>2</sup> / 24AWG (5 Pin)
Overvoltage Category	II	Material conductor insulation	SR-PVC
Pollution Degree	3	Flame resistance	VW-1 / FT-1
		Dielectric strength	NA

Standards and Regulations	
Design reference	IEC 61076-2-104: Detail specification for M8 connectors with screw-locking IEC 60512: Electromechanical components for electronic equipment; basic testing procedure and measuring methods IEC 60529: Degree of protection provided by enclosures (IP Code)
Certification reference	UL 2238

**Notice**  
The mechanical and electrical data performance can be ensured when the connector pair is correctly locked and fasten by specified torque. If the connector is not locked and or exposed in th contaminated enviroment, the connector must be sealed by the protective cover. Also, the influences from conductor, cable or PCB assembly must be taken into consideration.

## M8 B-Code Device Connector ( No Shield )

Coding and contacts	Code	<b>B</b>	
	Contact	<b>5</b>	
Rated voltage / current	30V / 3A		
Contact arrangement	Male	Female	
 			
<b>Front mounting with 0.5m wire</b>			
<b>Connector style</b>	<b>Mount thread</b>	<b>Part number</b>	
Male	M8 X 0.5	318-B5000-0VSL50	
Female	M8 X 0.5	319-B5000-0VSL50	
<b>Rear mounting with 0.5m wire</b>			
<b>Connector style</b>	<b>Mount thread</b>	<b>Part number</b>	
Male	M8 x 1	320-B5001-0VSL50	
Female	M10 x 0.75	321-B5002-0VSL50	
<b>Front mounting with solder cup</b>			
<b>Connector style</b>	<b>Mount thread</b>	<b>Part number</b>	
Male	M8 X 0.5	332-B5000-S	
Female	M8 X 0.5	333-B5000-S	
<b>Rear mounting with solder cup</b>			
<b>Connector style</b>	<b>Mount thread</b>	<b>Part number</b>	
Male	M8 x 1	330-B5001-S	
Female	M10 x 0.75	331-B5002-S	

The wire length can be customized. For more details, please contact Dinkle

## M8 B-Code One-piece PCB Circular Connector

### 180° Rear mounting, straight



### PCB Layout

Pin out	
Pin arrangement	<p>5P B code</p>

## M8 B-Code One-piece PCB Connector

Mechanical Properties		Material Properties	
Min. Insertion/withdrawal cycles	100	Contact / contact surface	Copper alloy / Gold plated
Degree of protection	IP67	Contact carrier	PA
Operating Temperature	-40°C ~ 80°C	Hexigonal nut / Outer Shield	Zinc die-cast, nickel-plated / Brass, nickel-plated
Fasten torque	0.4 Nm	O-ring	NBR
Soldering method	Wave Soldering	UL94 Flammability rating	V0
Electrical Properties		Cable Information	
Rated voltage / current (contacts)	30VAC / 3A (5 Pin)		
Rated Impulse Voltage	0.8kV (5 Pin)		
Insulation resistance	Min. 100MΩ		
Overvoltage Category	II		
Pollution Degree	3		
Standards and Regulations			
Design reference	IEC 61076-2-104: Detail specification for M8 connectors with screw-locking IEC 60512: Electromechanical components for electronic equipment; basic testing procedure and measuring methods IEC 60529: Degree of protection provided by enclosures (IP Code)		
Certification reference	UL 2238		

### Notice

The mechanical and electrical data performance can be ensured when the connector pair is correctly locked and fasten by specified torque. If the connector is not locked and or exposed in th contaminated enviroment, the connector must be sealed by the protective cover. Also, the influences from conductor, cable or PCB assembly must be taken into consideration.

## M8 A-Code One / Two-piece PCB Connector ( Shield / No Shield )

<b>Coding and contacts</b>	<b>Code</b>	<b>B</b>
	<b>Contact</b>	<b>5</b>
<b>Rated voltage / current</b>		30V / 3A
<b>Contact arrangement</b>	Male 	Female 
<b>Rear mounting, straight, No shield</b>		
<b>Connector style</b>	<b>Mount thread</b>	<b>Part number</b>
Male 	M8 X 1	<b>326-B5001-4</b>
Female 	M10 x 0.75	<b>327-B5002-4</b>
<b>Rear mounting, angled, shield</b>		
<b>Connector style</b>	<b>Mount thread</b>	<b>Part number</b>
Male 	M8 X 1	<b>328-B5001-4</b>
Female 	M10 x 0.75	<b>329-B5002-4</b>
<b>SMT Soldering, straight, No shield</b>		
<b>Connector style</b>	<b>package</b>	<b>Part number</b>
Male 	Tray	381-B5S00U-1
		381-B5S00U-2
Female 	Tape-and reel	382-B5S00U-1
		382-B5S00U-2
<b>Connector style</b>	<b>Mount thread</b>	<b>Part number</b>
Male 	M12 X 1	383-S1200
Female 	M12 X 1	384-S1200

**Bolded part number is cULus certified.**

Package unit, Tray : 60 pcs; Tape-and-Reel : 100 pcs

# M12 Circular Connector

Dinkle's M12 circular connectors with overmolded cable assemblies offer high stability and sealing performance. They provide waterproof and dustproof protection (IP67/IP68) when mated, making them a reliable solution for environments with moisture, large temperature variations, and vibrations. Dinkle offers high-quality PVC and PUR cables to meet your needs and shielded cables for additional options. The cable options also include drag chain cables with bending resistance guaranteed for 5 million cycles (R=28mm, L=1m, V=1m/s).

Dinkle's M12 panel-mounted connectors support shielded cables and use PUR cables with higher tensile strength, tear resistance, and wear resistance. These connectors are available in front-locking and rear-locking versions to suit varying installation requirements. Unshielded panel-mounted connectors, when paired with a sealing ring, provide excellent airtightness and waterproofing for equipment. Designed to be installed on equipment enclosures or panels, these connectors come in both front-locking and rear-locking configurations. Additionally, versions with solder cup contacts are available for customization alongside standard PVC wires.

The M12 one-piece PCB circular connectors cater to enclosure and PCB placement needs, offering 180-degree (Straight) and 90-degree (Angled) solder pin options for flexible installation orientations. For additional functionality, shielded one-piece PCB connectors are also available, equipped with pins connected to the metal housing for functional grounding (FE).

Dinkle's M12 two-piece PCB circular connectors consist of separate parts: a conductor carrier and a metal shell. The conductor carrier is made of high-temperature-resistant plastic, allowing for reflow soldering (THR) processes directly onto PCBs. With automated pick-and-place compatibility, the connectors are packaged in either tape-on-reel or tray options, reducing production costs in automated assembly.

Dinkle also offers field-assembly circular connectors that do not require factory pre-wiring. These connectors allow users to cut cable lengths and install connectors based on actual needs. In addition to convenience, Dinkle provides shielded options for addressing signal interference concerns.

For the M12 circular connector series, Dinkle offers a wide variety of codings (A, B, D, X, S, T, L, K, M, etc.) to accommodate diverse application requirements, including high-voltage and high-current environments.



## M12 A-Code Molded Circular Connector

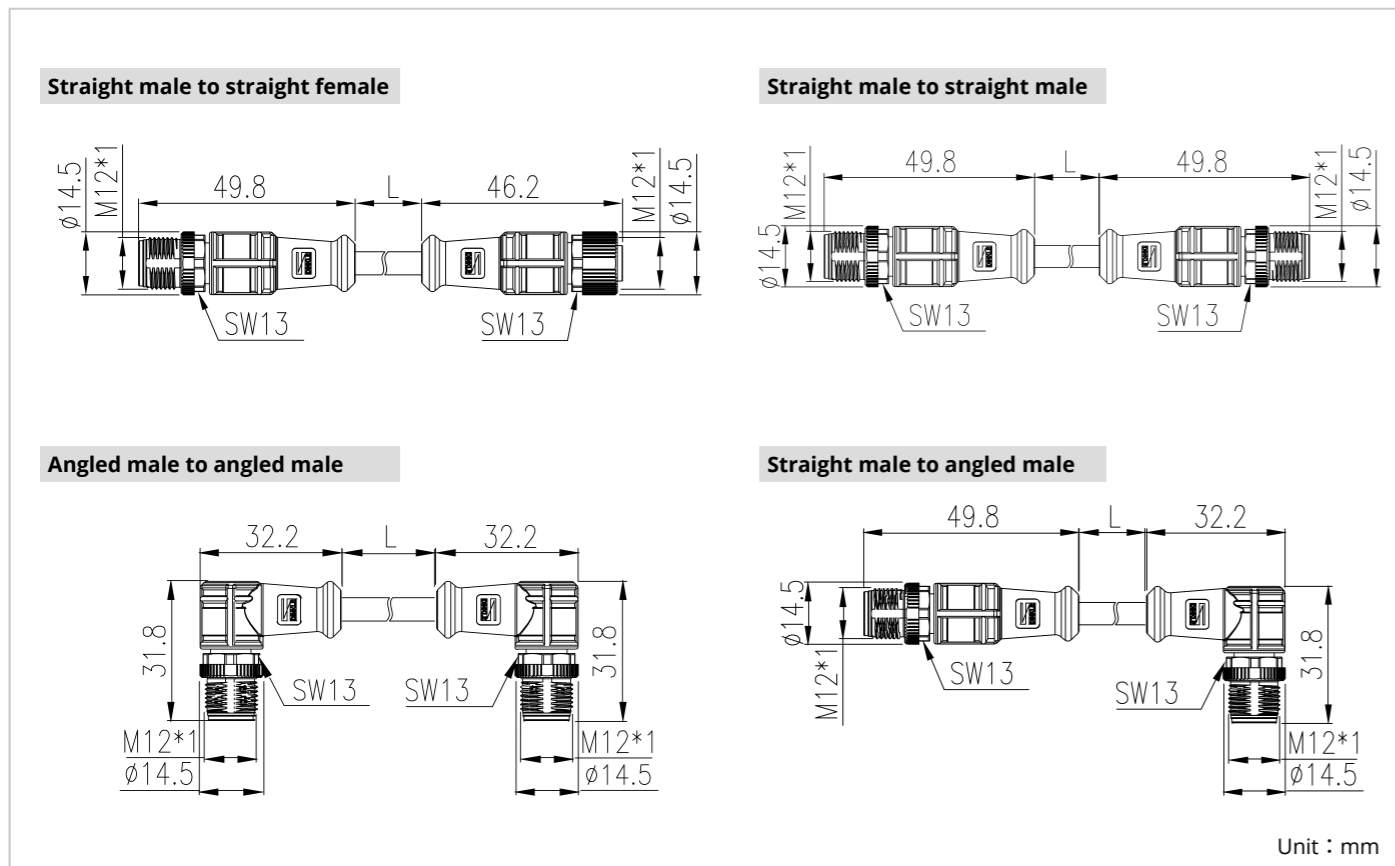
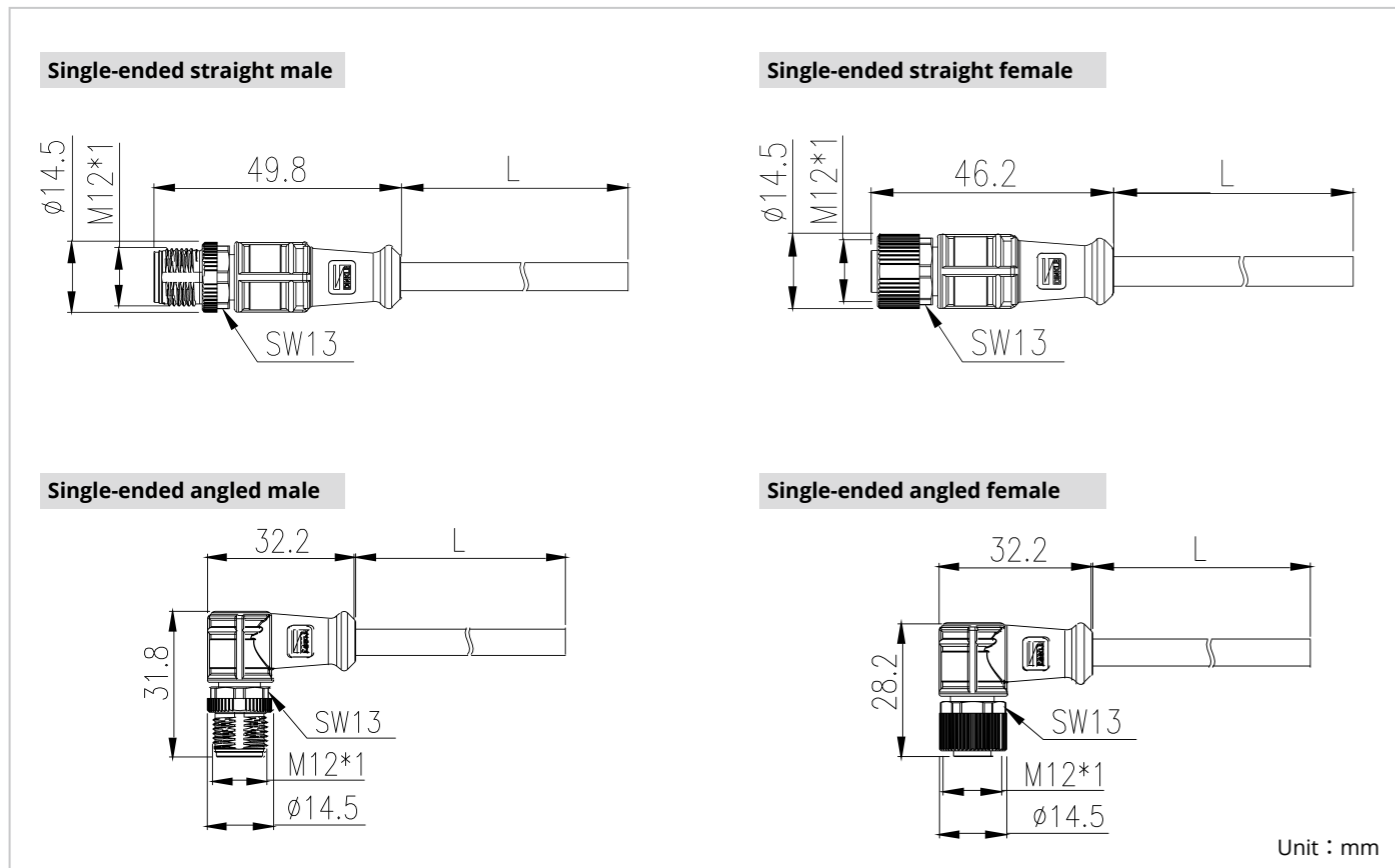







## M12 A-Code Molded Connector

Mechanical Properties		Material Properties		
Min. Insertion/withdrawal cycles	100	Contact / contact surface	Copper alloy / Gold plated	
Degree of protection	IP67/IP68	Contact carrier / overmolding	PUR	
Operating Temperature	-40°C ~ 80°C ( Fixed installation )	O-ring	NBR	
	-25°C ~ 80°C ( Fixed installation )	Cable gland material	Zinc die-cast, nickel-plated	
Fasten torque	0.4 Nm	UL94 Flammability rating	HB	
Electrical Properties		Cable Information		
Rated voltage / current (contacts)	250VAC / 4A (≤4 Pin)	Cable Jacket	PUR/PVC, BLACK	
	250VAC / 4A (5 Pin)		UL AWM style	Shield PUR : UL AWM 20549 / PVC : UL AWM 2464
	250VAC / 2A (8 Pin)			No Shield PUR : UL AWM 20549 / PVC : UL AWM 2464
	250VAC / 2.5A (12 Pin)			Drag chain PUR : UL AWM 20549
Rated Impulse Voltage	2.5kV (≤4 Pin)	Conductor cross section	0.34mm <sup>2</sup> /22AWG (≤4 Pin)	
	1.5kV (5 Pin)		0.34mm <sup>2</sup> /22AWG (5 Pin)	
	0.8kV (8 Pin)		0.25mm <sup>2</sup> /24AWG (8 Pin)	
	0.8kV (12 Pin)		0.14mm <sup>2</sup> /26AWG (12 Pin)	
Insulation resistance	Min. 100MΩ	Material conductor insulation	PE/PVC	
Overvoltage Category	II	Flame resistance	FT-2 / VW-1	
Pollution Degree	3	Dielectric strength	2.0KV/1min	
Standards and Regulations				
Design reference	IEC 61076-2-101: Detail specification for M12 connectors with screw-locking			
	IEC 60512: Electromechanical components for electronic equipment; basic testing procedure and measuring methods			
	IEC 60529: Degree of protection provided by enclosures (IP Code)			
Certification reference	UL 2238			

### Notice

The mechanical and electrical data performance can be ensured when the connector pair is correctly locked and fasten by specified torque. If the connector is not locked and or exposed in th contaminated enviroment, the connector must be sealed by the protective cover. Also, the influences from conductor, cable or PCB assembly must be taken into consideration.







## M12 A-Code Molded Connector ( Shield )

Coding and contacts		Code	A		A		A		A		A	
		Contact	3		4		5		8		12	
Rated voltage / current		250V / 4A		250V / 4A		60V / 4A		30V / 2A		30V / 1.5A		
Contact arrangement		Male	Female	Male	Female	Male	Female	Male	Female	Male	Female	
Connector style		Cable	Length (m)	Part number								
	PVC	2	<b>251-A3000-25S020</b>	<b>251-A4000-25S020</b>	<b>251-A5000-25S020</b>	251-A8000-25S020	251-AC000-25S020					
		5	<b>251-A3000-25S050</b>	<b>251-A4000-25S050</b>	<b>251-A5000-25S050</b>	251-A8000-25S050	251-AC000-25S050					
		10	<b>251-A3000-25S100</b>	<b>251-A4000-25S100</b>	<b>251-A5000-25S100</b>	251-A8000-25S100	251-AC000-25S100					
	PUR	2	<b>251-A3000-05S020</b>	<b>251-A4000-05S020</b>	<b>251-A5000-05S020</b>	251-A8000-05S020	251-AC000-05S020					
		5	<b>251-A3000-05S050</b>	<b>251-A4000-05S050</b>	<b>251-A5000-05S050</b>	251-A8000-05S050	251-AC000-05S050					
		10	<b>251-A3000-05S100</b>	<b>251-A4000-05S100</b>	<b>251-A5000-05S100</b>	251-A8000-05S100	251-AC000-05S100					
	PVC	2	<b>252-A3000-25S020</b>	<b>252-A4000-25S020</b>	<b>252-A5000-25S020</b>	252-A8000-25S020	252-AC000-25S020					
		5	<b>252-A3000-25S050</b>	<b>252-A4000-25S050</b>	<b>252-A5000-25S050</b>	252-A8000-25S050	252-AC000-25S050					
		10	<b>252-A3000-25S100</b>	<b>252-A4000-25S100</b>	<b>252-A5000-25S100</b>	252-A8000-25S100	252-AC000-25S100					
	PUR	2	<b>252-A3000-05S020</b>	<b>252-A4000-05S020</b>	<b>252-A5000-05S020</b>	252-A8000-05S020	252-AC000-05S020					
		5	<b>252-A3000-05S050</b>	<b>252-A4000-05S050</b>	<b>252-A5000-05S050</b>	252-A8000-05S050	252-AC000-05S050					
		10	<b>252-A3000-05S100</b>	<b>252-A4000-05S100</b>	<b>252-A5000-05S100</b>	252-A8000-05S100	252-AC000-05S100					
	PVC	2	<b>253-A3000-25S020</b>	<b>253-A4000-25S020</b>	<b>253-A5000-25S020</b>	253-A8000-25S020	253-AC000-25S020					
		5	<b>253-A3000-25S050</b>	<b>253-A4000-25S050</b>	<b>253-A5000-25S050</b>	253-A8000-25S050	253-AC000-25S050					
		10	<b>253-A3000-25S100</b>	<b>253-A4000-25S100</b>	<b>253-A5000-25S100</b>	253-A8000-25S100	253-AC000-25S100					
	PUR	2	<b>253-A3000-05S020</b>	<b>253-A4000-05S020</b>	<b>253-A5000-05S020</b>	253-A8000-05S020	253-AC000-05S020					
		5	<b>253-A3000-05S050</b>	<b>253-A4000-05S050</b>	<b>253-A5000-05S050</b>	253-A8000-05S050	253-AC000-05S050					
		10	<b>253-A3000-05S100</b>	<b>253-A4000-05S100</b>	<b>253-A5000-05S100</b>	253-A8000-05S100	253-AC000-05S100					
	PVC	2	<b>254-A3000-25S020</b>	<b>254-A4000-25S020</b>	<b>254-A5000-25S020</b>	254-A8000-25S020	254-AC000-25S020					
		5	<b>254-A3000-25S050</b>	<b>254-A4000-25S050</b>	<b>254-A5000-25S050</b>	254-A8000-25S050	254-AC000-25S050					
		10	<b>254-A3000-25S100</b>	<b>254-A4000-25S100</b>	<b>254-A5000-25S100</b>	254-A8000-25S100	254-AC000-25S100					
	PUR	2	<b>254-A3000-05S020</b>	<b>254-A4000-05S020</b>	<b>254-A5000-05S020</b>	254-A8000-05S020	254-AC000-05S020					
		5	<b>254-A3000-05S050</b>	<b>254-A4000-05S050</b>	<b>254-A5000-05S050</b>	254-A8000-05S050	254-AC000-05S050					
		10	<b>254-A3000-05S100</b>	<b>254-A4000-05S100</b>	<b>254-A5000-05S100</b>	254-A8000-05S100	254-AC000-05S100					
	PVC	0.6	<b>256-A3000-25SL60</b>	<b>256-A4000-25SL60</b>	<b>256-A5000-25SL60</b>	256-A8000-25SL60	256-AC000-25SL60					
		1.5	<b>256-A3000-25S015</b>	<b>256-A4000-25S015</b>	<b>256-A5000-25S015</b>	256-A8000-25S015	256-AC000-25S015					
		3	<b>256-A3000-25S030</b>	<b>256-A4000-25S030</b>	<b>256-A5000-25S030</b>	256-A8000-25S030	256-AC000-25S030					
	PUR	0.6	<b>256-A3000-05SL60</b>	<b>256-A4000-05SL60</b>	<b>256-A5000-05SL60</b>	256-A8000-05SL60	256-AC000-05SL60					
		1.5	<b>256-A3000-05S015</b>	<b>256-A4000-05S015</b>	<b>256-A5000-05S015</b>	256-A8000-05S015	256-AC000-05S015					
		3	<b>256-A3000-05S030</b>	<b>256-A4000-05S030</b>	<b>256-A5000-05S030</b>	256-A8000-05S030	256-AC000-05S030					
	PVC	0.6	<b>259-A3000-25SL60</b>	<b>259-A4000-25SL60</b>	<b>259-A5000-25SL60</b>	259-A8000-25SL60	259-AC000-25SL60					
		1.5	<b>259-A3000-25S015</b>	<b>259-A4000-25S015</b>	<b>259-A5000-25S015</b>	259-A8000-25S015	259-AC000-25S015					
		3	<b>259-A3000-25S030</b>	<b>259-A4000-25S030</b>	<b>259-A5000-25S030</b>	259-A8000-25S030	259-AC000-25S030					
	PUR	0.6	<b>259-A3000-05SL60</b>	<b>259-A4000-05SL60</b>	<b>259-A5000-05SL60</b>	259-A8000-05SL60	259-AC000-05SL60					
		1.5	<b>259-A3000-05S015</b>	<b>259-A4000-05S015</b>	<b>259-A5000-05S015</b>	259-A8000-05S015	259-AC000-05S015					
		3	<b>259-A3000-05S030</b>	<b>259-A4000-05S030</b>	<b>259-A5000-05S030</b>	259-A8000-05S030	259-AC000-05S030					

The configuration of connectors and the cable length can be customized. For more details, please contact Dinkle

**Bolded part number is cULus certified.**

## M12 A-Code Molded Connector ( No Shield )

Coding and contacts		Code	A		A		A		A		A	
		Contact	3		4		5		8		12	
Rated voltage / current		250V / 4A		250V / 4A		60V / 4A		30V / 2A		30V / 1.5A		
Contact arrangement		Male	Female	Male	Female	Male	Female	Male	Female	Male	Female	
Connector style		Cable	Length (m)	Part number								
	PVC	2	<b>201-A3000-20S020</b>	<b>201-A4000-20S020</b>	<b>201-A5000-20S020</b>	201-A8000-20S020	201-AC000-20S020					
		5	<b>201-A3000-20S050</b>	<b>201-A4000-20S050</b>	<b>201-A5000-20S050</b>	201-A8000-20S050	201-AC000-20S050					
		10	<b>201-A3000-20S100</b>	<b>201-A4000-20S100</b>	<b>201-A5000-20S100</b>	201-A8000-20S100	201-AC000-20S100					
	PUR	2	<b>201-A3000-00S020</b>	<b>201-A4000-00S020</b>	<b>201-A5000-00S020</b>	201-A8000-00S020	201-AC000-00S020					
		5	<b>201-A3000-00S050</b>	<b>201-A4000-00S050</b>	<b>201-A5000-00S050</b>	201-A8000-00S050	201-AC000-00S050					
		10	<b>201-A3000-00S100</b>	<b>201-A4000-00S100</b>	<b>201-A5000-00S100</b>	201-A8000-00S100	201-AC000-00S100					
	PVC	2	<b>202-A3000-20S020</b>	<b>202-A4000-20S020</b>	<b>202-A5000-20S020</b>	202-A8000-20S020	202-AC000-20S020					
		5	<b>202-A3000-20S050</b>	<b>202-A4000-20S050</b>	<b>202-A5000-20S050</b>	202-A8000-20S050	202-AC000-20S050					
		10	<b>202-A3000-20S100</b>	<b>202-A4000-20S100</b>	<b>202-A5000-20S100</b>	202-A8000-20S100	202-AC000-20S100					
	PUR	2	<b>202-A3000-00S020</b>	<b>202-A4000-00S020</b>	<b>202-A5000-00S020</b>	202-A8000-00S020	202-AC000-00S020					
		5	<b>202-A3000-00S050</b>	<b>202-A4000-00S050</b>	<b>202-A5000-00S050</b>	202-A8000-00S050	202-AC000-00S050					
		10	<b>202-A3000-00S100</b>	<b>202-A4000-00S100</b>	<b>202-A5000-00S100</b>	202-A8000-00S100	202-AC000-00S100					
	PVC	2	<b>203-A3000-20S020</b>	<b>203-A4000-20S020</b>	<b>203-A5000-20S020</b>	203-A8000-20S020	203-AC000-20S020					
		5	<b>203-A3000-20S050</b>	<b>203-A4000-20S050</b>	<b>203-A5000-20S050</b>	203-A8000-20S050	203-AC000-20S050					
		10	<b>203-A3000-20S100</b>	<b>203-A4000-20S100</b>	<b>203-A5000-20S100</b>	203-A8000-20S100	203-AC000-20S100					
	PUR	2	<b>203-A3000-00S020</b>	<b>203-A4000-00S020</b>	<b>203-A5000-00S020</b>	203-A8000-00S020	203-AC000-00S020					
		5	<b>203-A3000-00S050</b>	<b>203-A4000-00S050</b>	<b>203-A5000-00S050</b>	203-A8000-00S050	203-AC000-00S050					
		10	<b>203-A3000-00S100</b>	<b>203-A4000-00S100</b>	<b>203-A5000-00S100</b>	203-A8000-00S100	203-AC000-00S100					
	PVC	2	<b>204-A3000-20S020</b>	<b>204-A4000-20S020</b>	<b>204-A5000-20S020</b>	204-A8000-20S020	204-AC000-20S020					
		5	<b>204-A3000-20S050</b>	<b>204-A4000-20S050</b>	<b>204-A5000-20S050</b>	204-A8000-20S050	204-AC000-20S050					
		10	<b>204-A3000-20S100</b>	<b>204-A4000-20S100</b>	<b>204-A5000-20S100</b>	204-A8000-20S100	204-AC000-20S100					
	PUR	2	<b>204-A3000-00S020</b>	<b>204-A4000-00S020</b>	<b>204-A5000-00S020</b>	204-A8000-00S020	204-AC000-00S020					
		5	<b>204-A3000-00S050</b>	<b>204-A4000-00S050</b>	<b>204-A5000-00S050</b>	204-A8000-00S050	204-AC000-00S050					
		10	<b>204-A3000-00S100</b>	<b>204-A4000-00S100</b>	<b>204-A5000-00S100</b>	204-A8000-00S100	204-AC000-00S100					
	PVC	0.6	<b>206-A3000-20SL60</b>	<b>206-A4000-20SL60</b>	<b>206-A5000-20SL60</b>	206-A8000-20SL60	206-AC000-20SL60					
		1.5	<b>206-A3000-20S015</b>	<b>206-A4000-20S015</b>	<b>206-A5000-20S015</b>	206-A8000-20S015	206-AC000-20S015					
		3	<b>206-A3000-20S030</b>	<b>206-A4000-20S030</b>	<b>206-A5000-20S030</b>	206-A8000-20S030	206-AC000-20S030					
	PUR	0.6	<b>206-A3000-00SL60</b>	<b>206-A4000-00SL60</b>	<b>206-A5000-00SL60</b>	206-A8000-00SL60	206-AC000-00SL60					
		1.5	<b>206-A3000-00S015</b>	<b>206-A4000-00S015</b>	<b>206-A5000-00S015</b>	206-A8000-00S015	206-AC000-00S015					
		3	<b>206-A3000-00S030</b>	<b>206-A4000-00S030</b>	<b>206-A5000-00S030</b>	206-A8000-00S030	206-AC000-00S030					
	PVC	0.6	<b>209-A3000-20SL60</b>	<b>209-A4000-20SL60</b>	<b>209-A5000-20SL60</b>	209-A8000-20SL60	209-AC000-20SL60					
		1.5	<b>209-A3000-20S015</b>	<b>209-A4000-20S015</b>	<b>209-A5000-20S015</b>	209-A8000-20S015	209-AC000-20S015					
		3	<b>209-A3000-20S030</b>	<b>209-A4000-20S030</b>	<b>209-A5000-20S030</b>	209-A8000-20S030	209-AC000-20S030					
	PUR	0.6	<b>209-A3000-00SL60</b>	<b>209-A4000-00SL60</b>	<b>209-A5000-00SL60</b>	209-A8000-00SL60	209-AC000-00SL60					
		1.5	<b>209-A3000-00S015</b>	<b>209-A4000-00S015</b>	<b>209-A5000-00S015</b>	209-A8000-00S015	209-AC000-00S015					
		3	<b>209-A3000-00S030</b>	<b>209-A4000-00S030</b>	<b>209-A5000-00S030</b>	209-A8000-00S030	209-AC000-00S030					

**Bolded part number is cULus certified.**The configuration of connectors and the cable length can be customized. For more details, please contact Dinkle

## M12 A-Code Molded Connector ( No Shield, Drag, chain )

Coding and contacts	Code	A		A		A		A		A	
	Contact	3		4		5		8		12	
Rated voltage / current		250V / 4A		250V / 4A		60V / 4A		30V / 2A		30V / 1.5A	
Contact arrangement		Male	Female	Male	Female	Male	Female	Male	Female	Male	Female
Connector style	Cable	Length(m)	Part number								
Single-ended straight male 	PUR	2	201-A3000-02S020	201-A4000-02S020	201-A5000-02S020	201-A8000-02S020	201-AC000-02S020				
		5	201-A3000-02S050	201-A4000-02S050	201-A5000-02S050	201-A8000-02S050	201-AC000-02S050				
		10	201-A3000-02S100	201-A4000-02S100	201-A5000-02S100	201-A8000-02S100	201-AC000-02S100				
Single-ended straight female 	PUR	2	202-A3000-02S020	202-A4000-02S020	202-A5000-02S020	202-A8000-02S020	202-AC000-02S020				
		5	202-A3000-02S050	202-A4000-02S050	202-A5000-02S050	202-A8000-02S050	202-AC000-02S050				
		10	202-A3000-02S100	202-A4000-02S100	202-A5000-02S100	202-A8000-02S100	202-AC000-02S100				
Single-ended angled male 	PUR	2	203-A3000-02S020	203-A4000-02S020	203-A5000-02S020	203-A8000-02S020	203-AC000-02S020				
		5	203-A3000-02S050	203-A4000-02S050	203-A5000-02S050	203-A8000-02S050	203-AC000-02S050				
		10	203-A3000-02S100	203-A4000-02S100	203-A5000-02S100	203-A8000-02S100	203-AC000-02S100				
Single-ended angled female 	PUR	2	204-A3000-02S020	204-A4000-02S020	204-A5000-02S020	204-A8000-02S020	204-AC000-02S020				
		5	204-A3000-02S050	204-A4000-02S050	204-A5000-02S050	204-A8000-02S050	204-AC000-02S050				
		10	204-A3000-02S100	204-A4000-02S100	204-A5000-02S100	204-A8000-02S100	204-AC000-02S100				
Straight male mate straight female 	PUR	0.6	206-A3000-02SL60	206-A4000-02SL60	206-A5000-02SL60	206-A8000-02SL60	206-AC000-02SL60				
		1.5	206-A3000-02S015	206-A4000-02S015	206-A5000-02S015	206-A8000-02S015	206-AC000-02S015				
		3	206-A3000-02S030	206-A4000-02S030	206-A5000-02S030	206-A8000-02S030	206-AC000-02S030				
Angled male mate angled female 	PUR	0.6	209-A3000-02SL60	209-A4000-02SL60	209-A5000-02SL60	209-A8000-02SL60	209-AC000-02SL60				
		1.5	209-A3000-02S015	209-A4000-02S015	209-A5000-02S015	209-A8000-02S015	209-AC000-02S015				
			209-A3000-02S030	209-A4000-02S030	209-A5000-02S030	209-A8000-02S030	209-AC000-02S030				

Cables with drag chain function are guaranteed to withstand 5 million bending times(R=28mm, L=1m, V=1m/s)  
The configuration of connectors and the cable length can be customized. For more details, please contact Dinkle

## M12 A-Code Molded Y-splitter ( No Shield )

DINKLE Y-Splitter connectors are ideal for space-constrained industrial environments, offering great flexibility. The connector adopts an unshielded A-Code design, which can power two sensor/actuators simultaneously, which greatly simplifies the wiring time and reduces the installation costs while avoiding potential errors. The plastic-coated cable assemblies provide high structural stability and tightness, making connectors waterproof and dustproof with IP67 protection. This provides a rugged and reliable connection solution in harsh environments.

Coding and contacts	Code	A	
	Contact	5	
Rated voltage / current		60V / 4A	
Contact arrangement		Male	Female
Connector style	Cable	Part number	
( 1 x Straight male to 2 x straight female ) With cable ( length : 15cm ) 	PUR	222-A5530-00SL15	
	PVC	222-A5530-20SL15	
Without cable 	-	224-2A5100	

The cable length of 222 series can be customized. For more details, please contact Dinkle

### Dimension Drawing

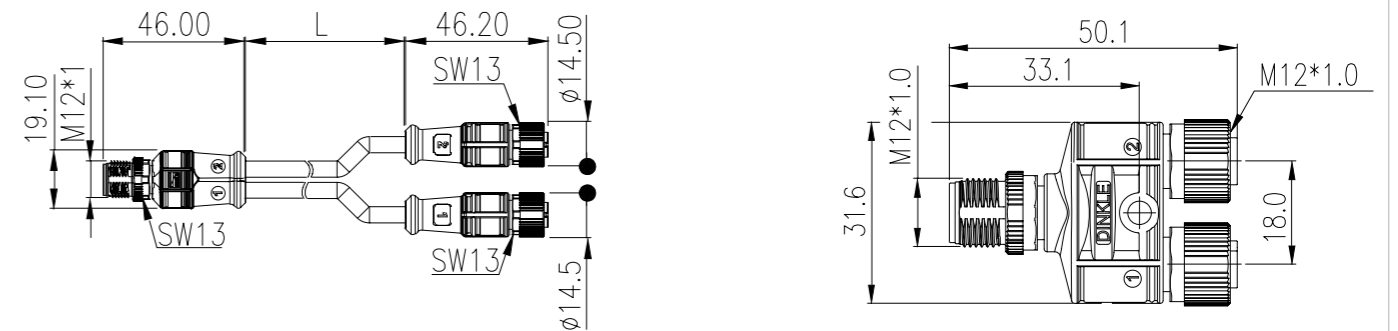

### Wiring diagram

Pin out	5	5	Grey	5	Grey
	4	4	Black	4	Black
	3	3	Blue	3	Blue
	2	2	White	2	White
	1	1	Brown	1	Brown
Pin arrangement					
	conn.3 5P	conn.2 5P	A code	conn.1 5P	

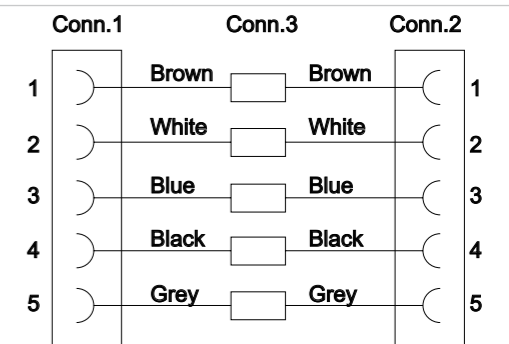

## M12 A-Code Device Circular Connector

### Front mounting with 0.5m wire

Male

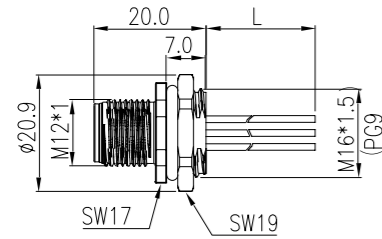

Female

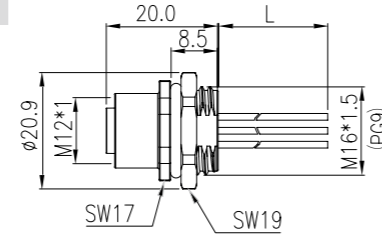

### Front mounting with solder pin

Male

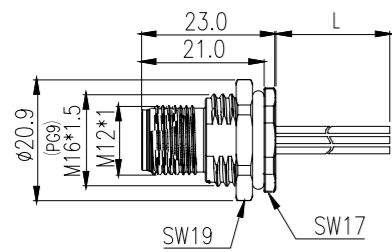

Female

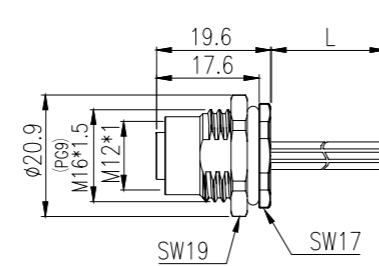

### Rear mounting with 0.5m wire

Male

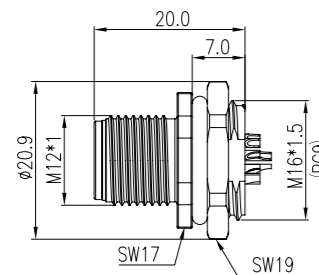

Female

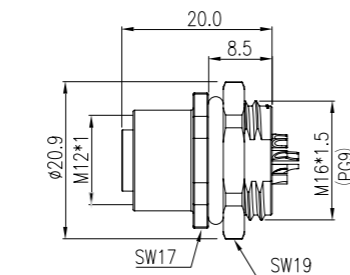

### Rear mounting with cup pin

Male

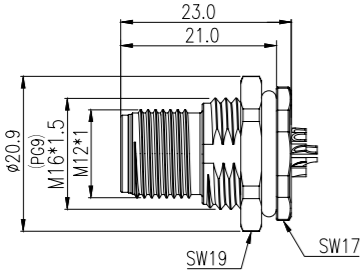

Female

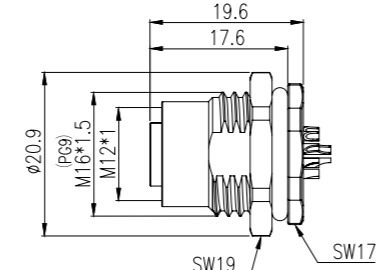

### Pin assignments and wire colors

Pin arrangement	A code				
	3P	4P	5P	8P	12P
Pin out	1	1	1	1	1
	2	2	2	2	2
	3	3	3	3	3
	4	4	4	4	4
	5	5	5	5	5
				6	6
				7	7
				8	8
				9	9
				10	10
				11	11
				12	12

## M12 A-Code Device Connector

Mechanical Properties		Material Properties	
Min. Insertion/withdrawal cycles	100	Contact / contact surface	Copper alloy / Gold plated
Degree of protection	IP67	Contact carrier	PA
Operating Temperature	-40°C ~ 80°C	Hexagonal nut / Outer Shield	Zinc die-cast, nickel-plated
Fasten torque	0.4 Nm	O-ring	NBR
Mounting torque	0.8 Nm	UL94 Flammability rating	V0

Electrical Properties		Cable Information		
Rated voltage / current (contacts)	250VAC / 4A (≤4 Pin)	Cable Jacket	Shield	PUR / PVC, BLACK
	60VAC / 4A (5 Pin)		No Shield	PVC
	30VAC / 2A (8 Pin)	UL AWM style	Shield	PUR : UL AWM 20549 / PVC : UL AWM 2464
	30VAC / 1.5A (12 Pin)		No Shield	PVC : UL AWM 1061
Rated Impulse Voltage	2.5kV (≤4 Pin)	Conductor cross section	0.34mm <sup>2</sup> / 22AWG (≤4 Pin)	
	1.5kV (5 Pin)		0.34mm <sup>2</sup> / 22AWG (5 Pin)	
	0.8kV (8 Pin)		0.25mm <sup>2</sup> / 24AWG (8 Pin)	
	0.8kV (12 Pin)		0.14mm <sup>2</sup> / 26AWG (12 Pin)	
Insulation resistance	Min. 100MΩ	Material conductor insulation	Shield	PE / PVC
Overvoltage Category	II	Flame resistance	FT-2 / VW-1	
Pollution Degree	3	Dielectric strength	2.0KV/1min	















### Standards and Regulations

Design reference	IEC 61076-2-101: Detail specification for M12 connectors with screw-locking IEC 60512: Electromechanical components for electronic equipment; basic testing procedure and measuring methods IEC 60529: Degree of protection provided by enclosures (IP Code)
Certification reference	UL 2238

### Notice



















The mechanical and electrical data performance can be ensured when the connector pair is correctly locked and fasten by specified torque. If the connector is not locked and or exposed in th contaminated enviroment, the connector must be sealed by the protective cover. Also, the influences from conductor, cable or PCB assembly must be taken into consideration.

## M12 A-Code Device Connector ( Shield )

Coding and contacts	Code	A		A		A		A		A	
	Contact	3		4		5		8		12	
Rated voltage / current		250V / 4A		250V / 4A		60V / 4A		30V / 2A		30V / 1.5A	
Contact arrangement		Male	Female	Male	Female	Male	Female	Male	Female	Female	Female
											
<b>2m PUR cable</b>											
Connector style	Mount thread	Part number									
 Male	M16 X 1.5	268-A3000-15S020	268-A4000-15S020	268-A5000-15S020	268-A8000-15S020	268-AC000-15S020					
	Pg9	268-A3002-15S020	268-A4002-15S020	268-A5002-15S020	268-A8002-15S020	268-AC002-15S020					
 Female	M16 X 1.5	269-A3000-15S020	269-A4000-15S020	269-A5000-15S020	269-A8000-15S020	269-AC000-15S020					
	Pg9	269-A3002-15S020	269-A4002-15S020	269-A5002-15S020	269-A8002-15S020	269-AC002-15S020					
 Male	M16 X 1.5	270-A3000-15S020	270-A4000-15S020	270-A5000-15S020	270-A8000-15S020	270-AC000-15S020					
	Pg9	270-A3002-15S020	270-A4002-15S020	270-A5002-15S020	270-A8002-15S020	270-AC002-15S020					
 Female	M16 X 1.5	271-A3000-15S020	271-A4000-15S020	271-A5000-15S020	271-A8000-15S020	271-AC000-15S020					
	Pg9	271-A3002-15S020	271-A4002-15S020	271-A5002-15S020	271-A8002-15S020	271-AC002-15S020					

The wire length can be customized. For more details, please contact Dinkle

## M12 A-Code Device Connector ( No Shield )

Coding and contacts	Code	A		A		A		A		A	
	Contact	3		4		5		8		12	
Rated voltage / current		250V / 4A		250V / 4A		60V / 4A		30V / 2A		30V / 1.5A	
Contact arrangement		Male	Female	Male	Female	Male	Female	Male	Female	Male	Female
											
<b>Front mounting with 0.5m wire</b>											
Connector style	Mount thread	Part number									
 Male	M16 X 1.5	<b>218-A3000-0VSL50</b>	<b>218-A4000-0VSL50</b>	<b>218-A5000-0VSL50</b>	<b>218-A8000-0VSL50</b>	<b>218-AC000-0VSL50</b>					
	Pg9	<b>218-A3002-0VSL50</b>	<b>218-A4002-0VSL50</b>	<b>218-A5002-0VSL50</b>	<b>218-A8002-0VSL50</b>	<b>218-AC002-0VSL50</b>					
 Female	M16 X 1.5	<b>219-A3000-0VSL50</b>	<b>219-A4000-0VSL50</b>	<b>219-A5000-0VSL50</b>	<b>219-A8000-0VSL50</b>	<b>219-AC000-0VSL50</b>					
	Pg9	<b>219-A3002-0VSL50</b>	<b>219-A4002-0VSL50</b>	<b>219-A5002-0VSL50</b>	<b>219-A8002-0VSL50</b>	<b>219-AC002-0VSL50</b>					
<b>Rear mounting with 0.5m wire</b>											
Connector style	Mount thread	Part number									
 Male	M16 X 1.5	<b>220-A3000-0VSL50</b>	<b>220-A4000-0VSL50</b>	<b>220-A5000-0VSL50</b>	<b>220-A8000-0VSL50</b>	<b>220-AC000-0VSL50</b>					
	Pg9	<b>220-A3002-0VSL50</b>	<b>220-A4002-0VSL50</b>	<b>220-A5002-0VSL50</b>	<b>220-A8002-0VSL50</b>	<b>220-AC002-0VSL50</b>					
 Female	M16 X 1.5	<b>221-A3000-0VSL50</b>	<b>221-A4000-0VSL50</b>	<b>221-A5000-0VSL50</b>	<b>221-A8000-0VSL50</b>	<b>221-AC000-0VSL50</b>					
	Pg9	<b>221-A3002-0VSL50</b>	<b>221-A4002-0VSL50</b>	<b>221-A5002-0VSL50</b>	<b>221-A8002-0VSL50</b>	<b>221-AC002-0VSL50</b>					
<b>Front mounting with solder cup</b>											
Connector style	Mount thread	Part number									
 Male	M16 X 1.5	<b>232-A3000-S</b>	<b>232-A4000-S</b>	<b>232-A5000-S</b>	<b>232-A8000-S</b>	<b>232-AC000-S</b>					
	Pg9	<b>232-A3002-S</b>	<b>232-A4002-S</b>	<b>232-A5002-S</b>	<b>232-A8002-S</b>	<b>232-AC002-S</b>					
 Female	M16 X 1.5	<b>233-A3000-S</b>	<b>233-A4000-S</b>	<b>233-A5000-S</b>	<b>233-A8000-S</b>	<b>233-AC000-S</b>					
	Pg9	<b>233-A3002-S</b>	<b>233-A4002-S</b>	<b>233-A5002-S</b>	<b>233-A8002-S</b>	<b>233-AC002-S</b>					
<b>Rear mounting with solder cup</b>											
Connector style	Mount thread	Part number									
 Male	M16 X 1.5	<b>230-A3000-S</b>	<b>230-A4000-S</b>	<b>230-A5000-S</b>	<b>230-A8000-S</b>	<b>230-AC000-S</b>					
	Pg9	<b>230-A3002-S</b>	<b>230-A4002-S</b>	<b>230-A5002-S</b>	<b>230-A8002-S</b>	<b>230-AC002-S</b>					
 Female	M16 X 1.5	<b>231-A3000-S</b>	<b>231-A4000-S</b>	<b>231-A5000-S</b>	<b>231-A8000-S</b>	<b>231-AC000-S</b>					
	Pg9	<b>231-A3002-S</b>	<b>231-A4002-S</b>	<b>231-A5002-S</b>	<b>231-A8002-S</b>	<b>231-AC002-S</b>					

**Bolded part number is cULus certified** The wire length can be customized. For more details, please contact Dinkle

# M12 A-Code One-piece PCB Circular Connector

## 180° Rear mounting, straight (Shielded)

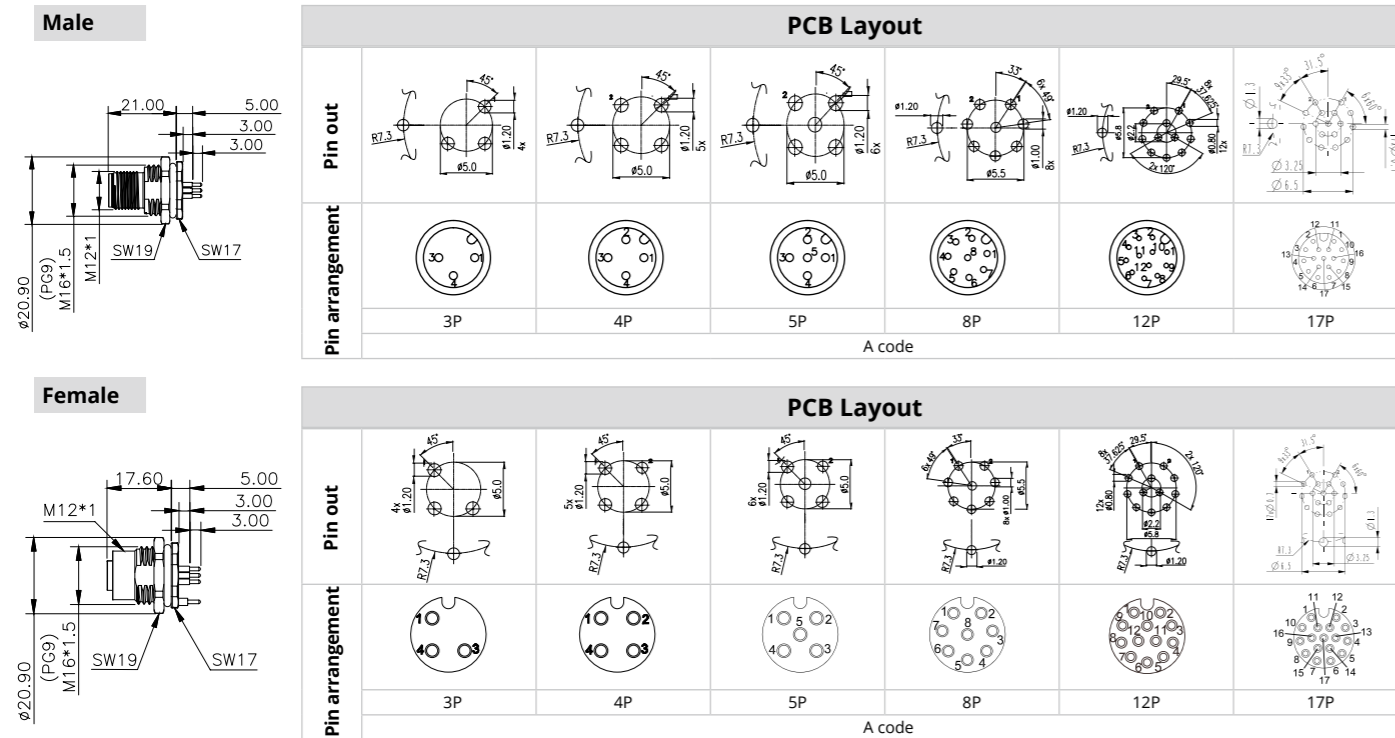

## 180° Rear mounting, straight (NonShielded)

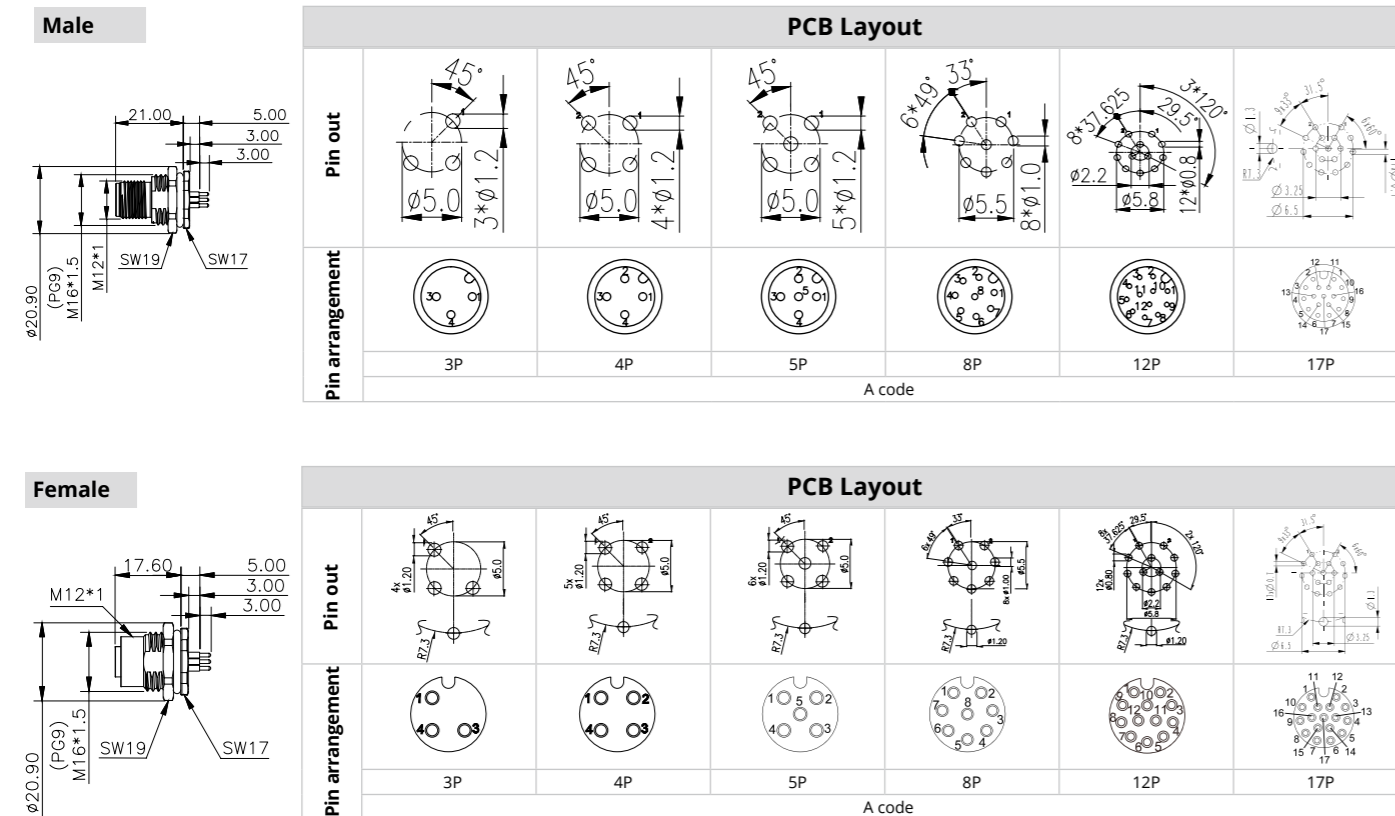

# M12 A-Code One-piece PCB Circular Connector

## 90° Rear mounting, straight (Shielded)

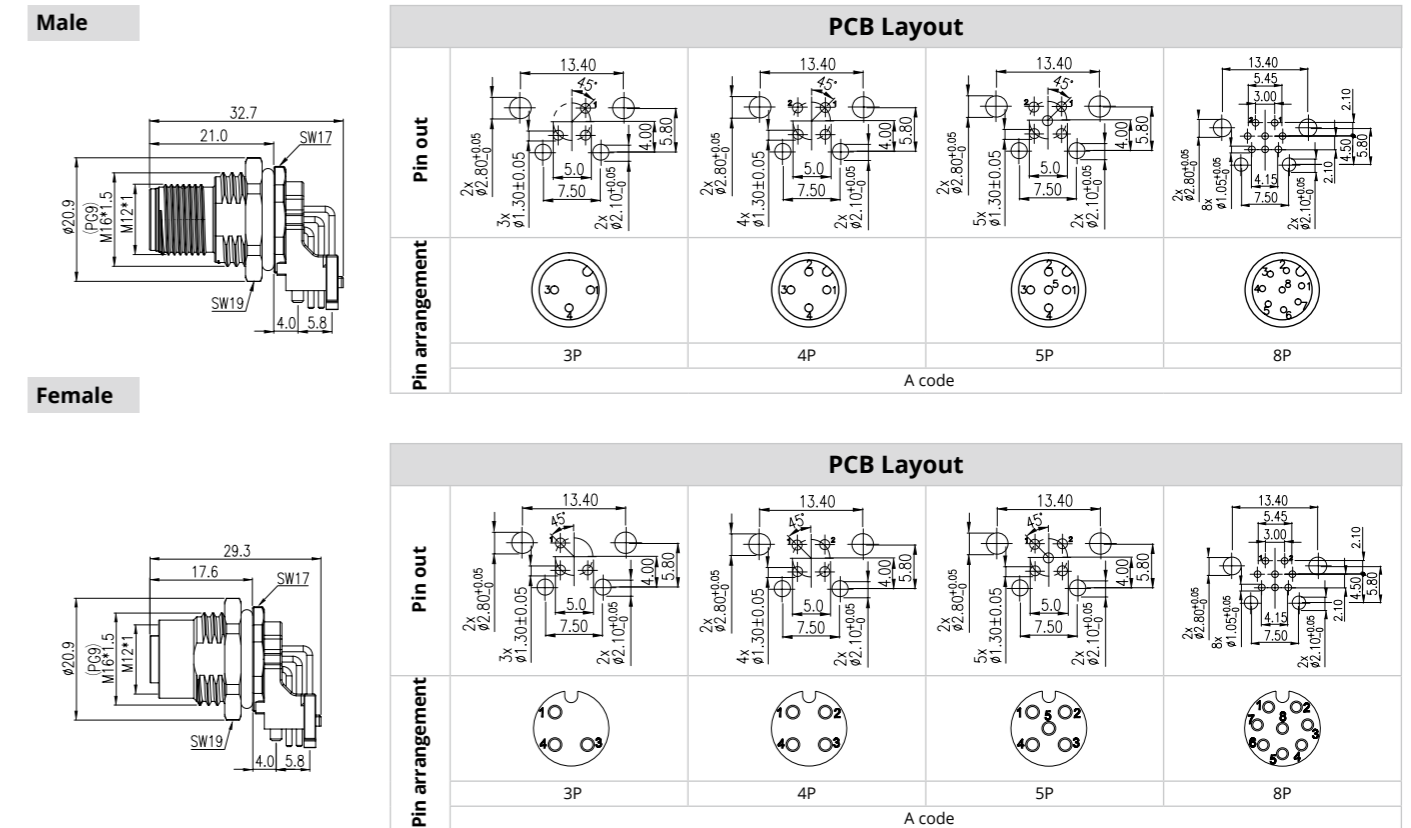

## 90° Rear mounting, straight (NonShielded)

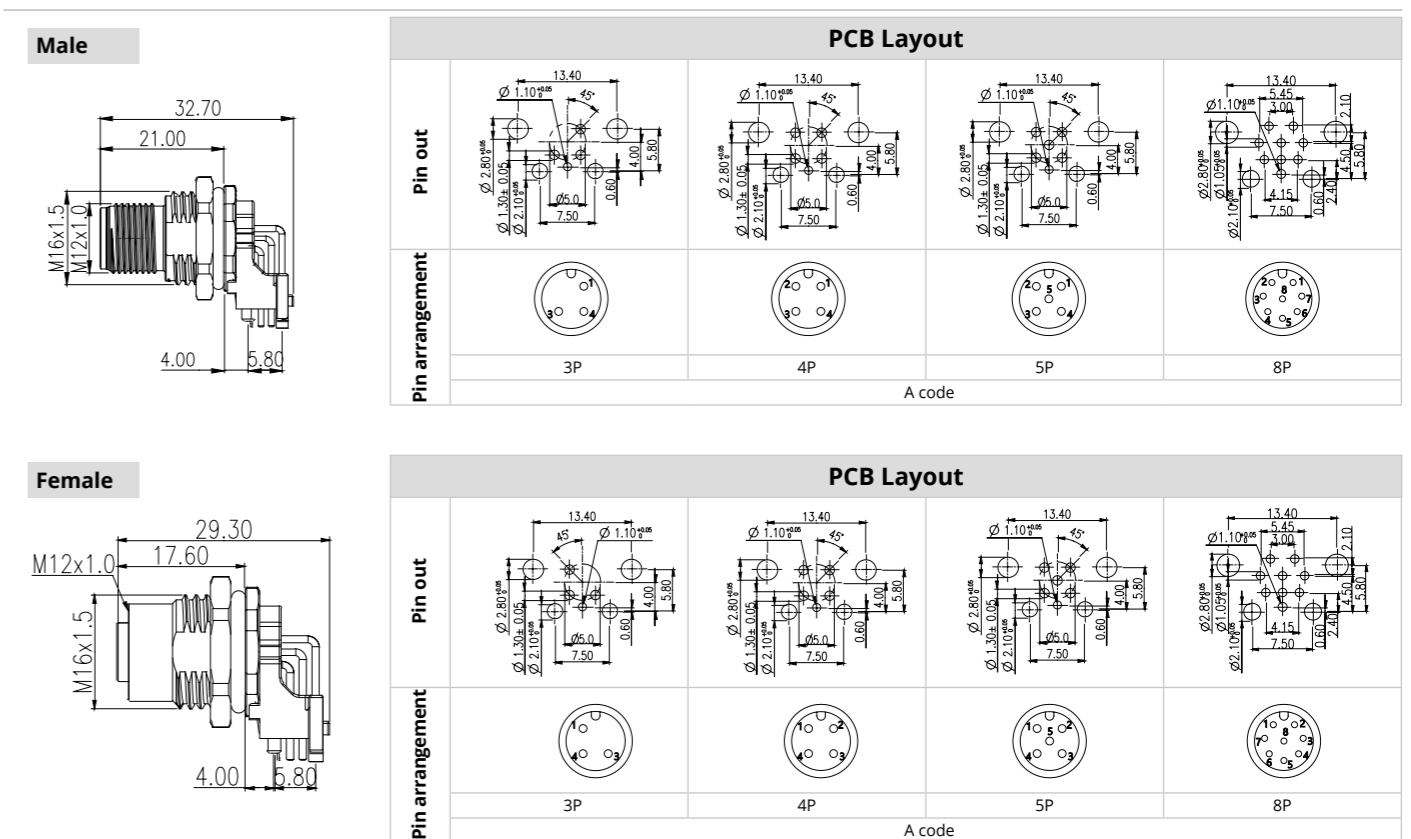

## M12 A-Code One-piece PCB Connector

Mechanical Properties		Material Properties	
Min. Insertion/withdrawal cycles	100	Contact / contact surface	Copper alloy / Gold plated
Degree of protection	IP67	Contact carrier	PA
Operating Temperature	-40°C ~ 80°C	Hexigonal nut / Outer Shield	Zinc die-cast, nickel-plated / Brass, nickel-plated
Fasten torque	0.4 Nm	O-ring	NBR
Soldering method	Wave Soldering	UL94 Flammability rating	V0

Electrical Properties		Cable Information	
Contact / contact surface	250VAC / 4A (≤4 Pin)		
	60VAC / 4A (5 Pin)		
	30VAC / 2A (8 Pin)		
	30VAC / 1.5A (≥12 Pin)		
Rated Impulse Voltage	2.5kV (≤4 Pin)		
	1.5kV (5 Pin)		
	0.8kV (8 Pin)		
	0.8kV (≥12 Pin)		
Insulation resistance	Min. 100MΩ		
Overvoltage Category	II		
Pollution Degree	3		

### Standards and Regulations

Design reference	IEC 61076-2-101: Detail specification for M12 connectors with screw-locking
	IEC 61076-2-111: Circular connectors - Detail specification for power connectors with M12 screw-locking
	IEC 60512: Electromechanical components for electronic equipment; basic testing procedure and measuring methods
Certification reference	IEC 60529: Degree of protection provided by enclosures (IP Code)
	UL 2238

### Notice

The mechanical and electrical data performance can be ensured when the connector pair is correctly locked and fasten by specified torque. If the connector is not locked and or exposed in th contaminated enviroment, the connector must be sealed by the protective cover. Also, the influences from conductor, cable or PCB assembly must be taken into consideration.

## M12 A-Code One-piece PCB Connector ( Shield / No Shield )

Coding and contacts	Code Contact	A 3		A 4		A 5		A 8		A 12		A 17	
		Male	Female	Male	Female	Male	Female	Male	Female	Male	Female	Male	Female
<b>Rated voltage / current</b>		250V / 4A		250V / 4A		60V / 4A		30V / 2A		30V / 1.5A		30V / 1.5A	
<b>Contact arrangement</b>													
<b>Rear mounting, straight, Shield</b>													
<b>Connector style</b>	<b>Mount thread</b>	<b>Part number</b>											
	Male	M16 X 1.5	<b>276-A3000-6</b>	<b>276-A4000-6</b>	<b>276-A5000-6</b>	<b>276-A8000-6</b>	<b>276-AC000-6</b>	<b>276-AH000-6</b>					
	Pg9	<b>276-A3002-6</b>	<b>276-A4002-6</b>	<b>276-A5002-6</b>	<b>276-A8002-6</b>	<b>276-AC002-6</b>	<b>276-AH002-6</b>						
	Female	M16 X 1.5	<b>277-A3000-6</b>	<b>277-A4000-6</b>	<b>277-A5000-6</b>	<b>277-A8000-6</b>	<b>277-AC000-6</b>	<b>277-AH000-6</b>					
	Pg9	<b>277-A3002-6</b>	<b>277-A4002-6</b>	<b>277-A5002-6</b>	<b>277-A8002-6</b>	<b>277-AC002-6</b>	<b>277-AH002-6</b>						
<b>Rear mounting, straight, No Shield</b>													
<b>Connector style</b>	<b>Mount thread</b>	<b>Part number</b>											
	Male	M16 X 1.5	<b>226-A3000-6</b>	<b>226-A4000-6</b>	<b>226-A5000-6</b>	<b>226-A8000-6</b>	<b>226-AC000-6</b>	<b>226-AH000-6</b>					
	Pg9	<b>226-A3002-6</b>	<b>226-A4002-6</b>	<b>226-A5002-6</b>	<b>226-A8002-6</b>	<b>226-AC002-6</b>	<b>226-AH002-6</b>						
	Female	M16 X 1.5	<b>227-A3000-6</b>	<b>227-A4000-6</b>	<b>227-A5000-6</b>	<b>227-A8000-6</b>	<b>227-AC000-6</b>	<b>227-AH000-6</b>					
	Pg9	<b>227-A3002-6</b>	<b>227-A4002-6</b>	<b>227-A5002-6</b>	<b>227-A8002-6</b>	<b>227-AC002-6</b>	<b>227-AH002-6</b>						
<b>Rear mounting, angled, Shield</b>													
<b>Connector style</b>	<b>Mount thread</b>	<b>Part number</b>											
	Male	M16 X 1.5	278-A3000-3	278-A4000-3	278-A5000-3	278-A8000-3	-	-					
	Pg9	278-A3002-3	278-A4002-3	278-A5002-3	278-A8002-3	-	-						
	Female	M16 X 1.5	279-A3000-3	279-A4000-3	279-A5000-3	279-A8000-3	-	-					
	Pg9	279-A3002-3	279-A4002-3	279-A5002-3	279-A8002-3	-	-						
<b>Rear mounting, angled, No Shield</b>													
<b>Connector style</b>	<b>Mount thread</b>	<b>Part number</b>											
	Male	M16 X 1.5	228-A3000-3	228-A4000-3	228-A5000-3	228-A8000-3	-	-					
	Pg9	228-A3002-3	228-A4002-3	228-A5002-3	228-A8002-3	-	-						
	Female	M16 X 1.5	229-A3000-3	229-A4000-3	229-A5000-3	229-A8000-3	-	-					
	Pg9	229-A3002-3	229-A4002-3	229-A5002-3	229-A8002-3	-	-						

Bolded part number is cULus certified.

## M12 A-Code Two-piece PCB Circular Connector

### 180° Rear mounting, straight (Shielded)

Male

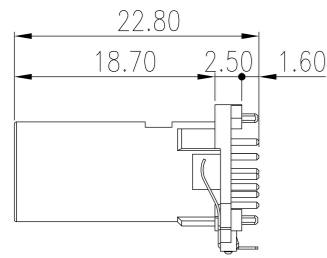

PCB Layout	
<b>Pin out</b>	
<b>Pin arrangement</b>	
	3P 4P 5P 8P 12P 17P
	A-code

Female

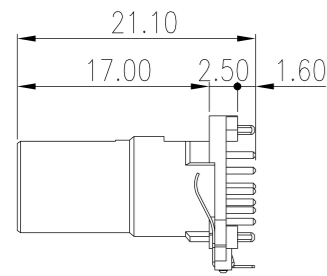

PCB Layout	
<b>Pin out</b>	
<b>Pin arrangement</b>	
	3P 4P 5P 8P 12P 17P
	A-code

### 180° Rear mounting, straight (NonShielded)

Male

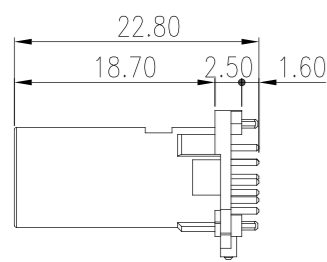

PCB Layout	
<b>Pin out</b>	
<b>Pin arrangement</b>	
	3P 4P 5P 8P 12P 17P
	A-code

Female

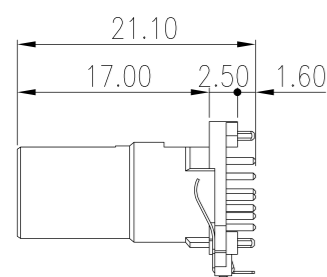

PCB Layout	
<b>Pin out</b>	
<b>Pin arrangement</b>	
	3P 4P 5P 8P 12P 17P
	A-code

## M12 A-Code Two-piece PCB Connector

Mechanical Properties		Material Properties	
Min. Insertion/withdrawal cycles	100	Contact / contact surface	Copper alloy / Gold plated
Degree of protection	IP67	Contact carrier	LCP
Operating Temperature	-40°C ~ 125°C	O-ring	SILICONE
		Moisture Sensitivity Levels	1
Soldering method	THR / SMT	UL94 Flammability rating	V0

Electrical Properties		Cable Information	
Rated voltage / current (contacts)	250VAC / 4A (≤4 Pin)		
	60VAC / 4A (5 Pin)		
	30VAC / 2A (8 Pin)		
	30VAC / 1.5A (≥12 Pin)		
Rated Impulse Voltage	2.5kV (≤4 Pin)		
	1.5kV (5 Pin)		
	0.8kV (8 Pin)		
	0.8kV (≥12 Pin)		
Insulation resistance	Min. 100MΩ		
Overvoltage Category	II		
Pollution Degree	3		

### Standards and Regulations

Design reference	IEC 61076-2-101: Detail specification for M12 connectors with screw-locking
	IEC 60512: Electromechanical components for electronic equipment; basic testing procedure and measuring methods
	IEC 60529: Degree of protection provided by enclosures (IP Code)

### Notice

The mechanical and electrical data performance can be ensured when the connector pair is correctly locked and fasten by specified torque. If the connector is not locked and or exposed in th contaminated enviroment, the connector must be sealed by the protective cover. Also, the influences from conductor, cable or PCB assembly must be taken into consideration.

## M12 A-Code Two-piece PCB Connector ( Shield / No Shield )

Coding and contacts	Code	A		A		A		A		A		A	
	Contact	3		4		5		8		12		17	
Rated voltage / current	250V / 4A		250V / 4A		60V / 4A		30V / 2A		30V / 1.5A		30V / 0.5A		
Contact arrangement	Male	Female		Male		Female		Male		Female		Male	
THR Soldering, straight, shield													
Connector style	package	Part number											
 Male	Tray	<b>281-A3T00S-1</b>	<b>281-A4T00S-1</b>	<b>281-A5T00S-1</b>	<b>281-A8T00S-1</b>	<b>281-AC100S-1</b>							281-AH100S-1
	Tape-and reel	<b>281-A3T00S-2</b>	<b>281-A4T00S-2</b>	<b>281-A5T00S-2</b>	<b>281-A8T00S-2</b>	<b>281-AC100S-2</b>							281-AH100S-2
 Female	Tray	<b>282-A3T00S-1</b>	<b>282-A4T00S-1</b>	<b>282-A5T00S-1</b>	<b>282-A8T00S-1</b>	<b>282-AC100S-1</b>							282-AH100S-1
	Tape-and reel	<b>282-A3T00S-2</b>	<b>282-A4T00S-2</b>	<b>282-A5T00S-2</b>	<b>282-A8T00S-2</b>	<b>282-AC100S-2</b>							282-AH100S-2
THR Soldering, straight, No shield													
Connector style	package	Part number											
 Male	Tray	<b>281-A3T00U-1</b>	<b>281-A4T00U-1</b>	<b>281-A5T00U-1</b>	<b>281-A8T00U-1</b>	<b>281-AC100U-1</b>							281-AH100U-1
	Tape-and reel	<b>281-A3T00U-2</b>	<b>281-A4T00U-2</b>	<b>281-A5T00U-2</b>	<b>281-A8T00U-2</b>	<b>281-AC100U-2</b>							281-AH100U-2
 Female	Tray	<b>282-A3T00U-1</b>	<b>282-A4T00U-1</b>	<b>282-A5T00U-1</b>	<b>282-A8T00U-1</b>	<b>282-AC100U-1</b>							282-AH100U-1
	Tape-and reel	<b>282-A3T00U-2</b>	<b>282-A4T00U-2</b>	<b>282-A5T00U-2</b>	<b>282-A8T00U-2</b>	<b>282-AC100U-2</b>							282-AH100U-2
SMT Soldering, straight, No shield													
Connector style	package	Part number											
 Female	Tray	-	-	<b>282-A5S00U-1</b>	-	-							-
	Tape-and reel	-	-	<b>282-A5S00U-2</b>	-	-							-
Metal housing													
Connector style	Mount thread	Part number											
 Male use	M16 X 1.5	283-T1100											
	Female use	M16 X 1.5	284-T1100										

**Bolded part number is cULus certified.**

Package unit, Tray : 60 pcs; Tape-and-Reel : 100 pcs

## M12 A-Code Field Attachable Circular Connector

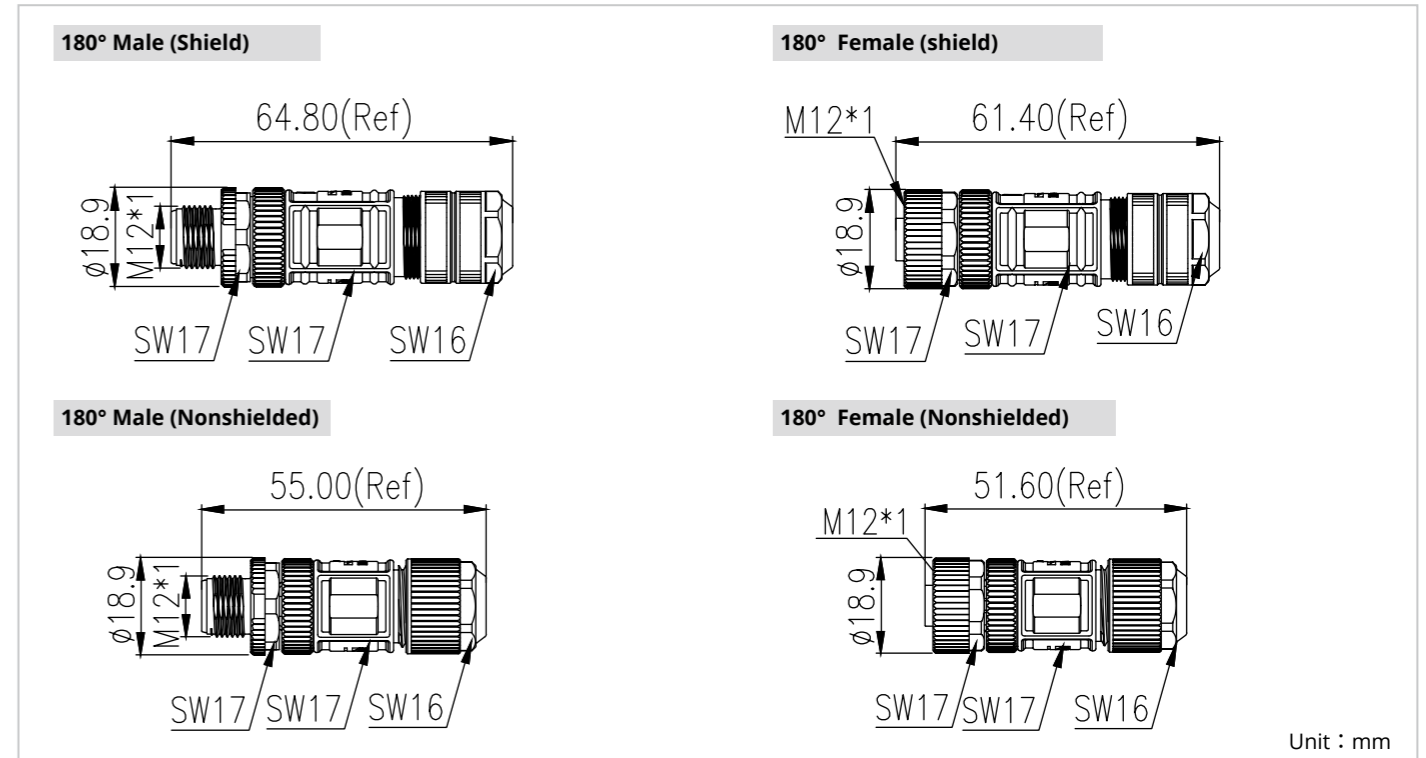

## M12 A-Code Field Attachable Connector

Mechanical Properties		Material Properties	
Min. Insertion/withdrawal cycles	100	Contact / contact surface	Copper alloy / Gold plated
Degree of protection	IP67	Contact carrier / push switch	PA / NA
Operating Temperature	-40°C ~ 125°C	O-ring	NBR
Soldering method	Manual soldering	Outer Shield	PA66 / Zinc die-cast
		UL94 Flammability rating	V0
Electrical Properties		Cable Information	
Rated voltage / current (contacts)	250VAC / 4A (≤4 Pin)	Wiring diameter	18AWG~26AWG
	60VAC / 4A (5 Pin)	Applicable cable diameter	φ4~φ8
Rated Impulse Voltage	2.5kV (≤4 Pin)		
	1.5kV (5 Pin)		
Insulation resistance	Min. 100MΩ		
Overvoltage Category	II		
Pollution Degree	3		
Standards and Regulations			
Design reference	IEC 61076-2-101: Detail specification for M12 connectors with screw-locking IEC 60512: Electromechanical components for electronic equipment; basic testing procedure and measuring methods IEC 60529: Degree of protection provided by enclosures (IP Code)		
Certification reference	UL 2238		

### Notice

The mechanical and electrical data performance can be ensured when the connector pair is correctly locked and fasten by specified torque. If the connector is not locked and or exposed in th contaminated enviroment, the connector must be sealed by the protective cover. Also, the influences from conductor, cable or PCB assembly must be taken into consideration.

## M12 A-Code Field Attachable Connector ( Shield / No Shield )

Coding and contacts	Code	A		A		A	
	Contact	3		4		5	
Rated voltage / current		250V / 4A		250V / 4A		60V / 4A	
Contact arrangement	Male						
	Female						
<b>Shield</b>							
Connector style	Wiring method	Part number					
Male 	Soldering Type	293-A3A1		293-A4A1		293-A5A1	
Female 		294-A3A1		294-A4A1		294-A5A1	
<b>No Shield</b>							
Connector style	Wiring method	Part number					
Male 	Soldering Type	243-A3A0		243-A4A0		243-A5A0	
Female 		244-A3A0		244-A4A0		244-A5A0	

## M12 B-Code Molded Circular Connector

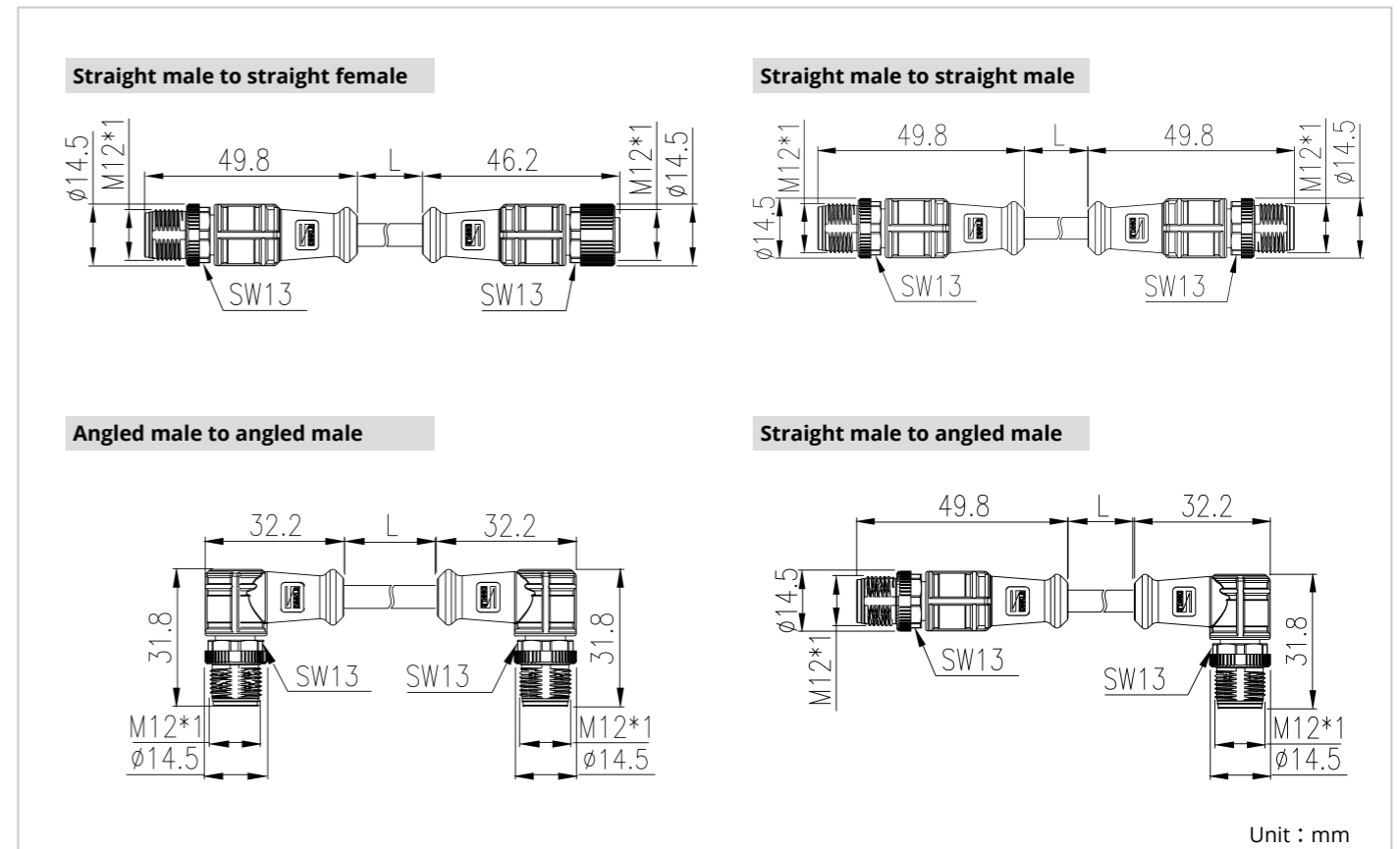
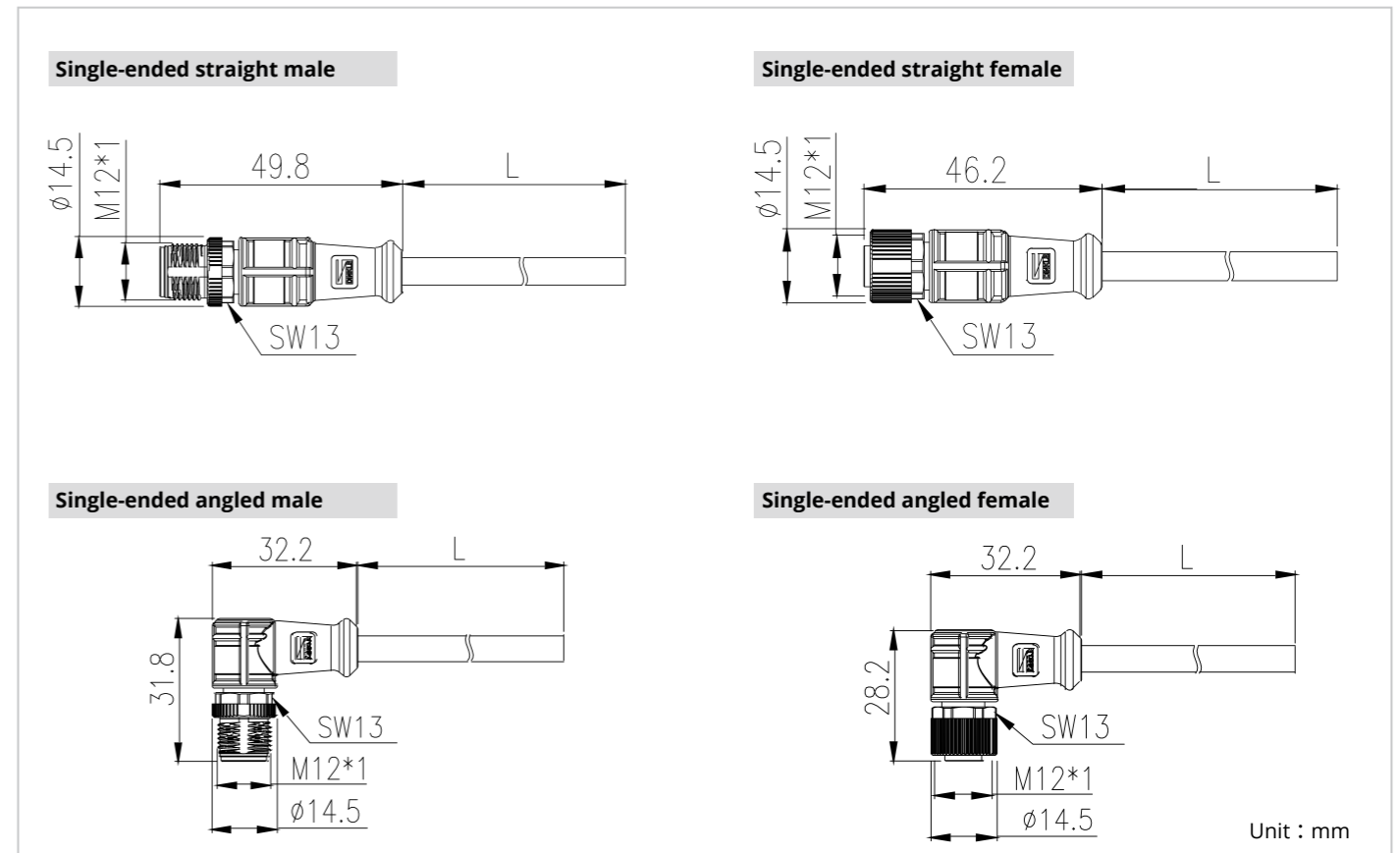

## M12 B-Code Molded Connector













Mechanical Properties		Material Properties	
Min. Insertion/withdrawal cycles	100	Contact / contact surface	Copper alloy / Gold plated
Degree of protection	IP67/IP68	Contact carrier / overmolding	PUR / PUR
Operating Temperature	-40°C ~ 80°C ( Fixed installation )	O-ring	NBR
	-25°C ~ 80°C ( Flexible installation )	Cable gland material	Zinc die-cast, nickel-plated
Fasten torque	0.4 Nm	UL94 Flammability rating	HB
Electrical Properties		Cable Information	
Rated voltage / current (contacts)	250VAC / 4A (≤4 Pin)	Cable Jacket	PUR/PVC, BLACK
	250VAC / 4A (5 Pin)	UL AWM style	Shield PUR : UL AWM 20549 PVC : UL AWM 2464
Rated Impulse Voltage	2.5kV (≤4 Pin)		No Shield PUR : UL AWM 20549 PVC : UL AWM 2464
	1.5kV (5 Pin)		Drag chain PUR : UL AWM 20549
Insulation resistance	Min. 100MΩ	Conductor cross section	0.34mm <sup>2</sup> /22AWG (≤4 Pin)
Overvoltage Category	II		0.34mm <sup>2</sup> /22AWG (5 Pin)
Pollution Degree	3	Material conductor insulation	PE/PVC
		Flame resistance	FT-2 / VW-1
		Dielectric strength	2.0KV/1min
Standards and Regulations			
Design reference	IEC 61076-2-101: Detail specification for M12 connectors with screw-locking		
	IEC 60512: Electromechanical components for electronic equipment; basic testing procedure and measuring methods		
	IEC 60529: Degree of protection provided by enclosures (IP Code)		
Certification reference	UL 2238		
Notice			
The mechanical and electrical data performance can be ensured when the connector pair is correctly locked and fasten by specified torque. If the connector is not locked and or exposed in th contaminated enviroment, the connector must be sealed by the protective cover. Also, the influences from conductor, cable or PCB assembly must be taken into consideration.			

## M12 B-Code Molded Connector ( Shield )

Coding and contacts	Code Contact	B 3		B 4		B 5	
		Male	Female	Male	Female	Male	Female
Rated voltage / current		250V / 4A		250V / 4A		60V / 4A	
Contact arrangement							
Connector style	Cable	Length(m)	Part number				
Single-ended straight male 	PVC	2	<b>251-B3000-25S020</b>	<b>251-B4000-25S020</b>	<b>251-B5000-25S020</b>		
		5	<b>251-B3000-25S050</b>	<b>251-B4000-25S050</b>	<b>251-B5000-25S050</b>		
		10	<b>251-B3000-25S100</b>	<b>251-B4000-25S100</b>	<b>251-B5000-25S100</b>		
	PUR	2	<b>251-B3000-05S020</b>	<b>251-B4000-05S020</b>	<b>251-B5000-05S020</b>		
		5	<b>251-B3000-05S050</b>	<b>251-B4000-05S050</b>	<b>251-B5000-05S050</b>		
		10	<b>251-B3000-05S100</b>	<b>251-B4000-05S100</b>	<b>251-B5000-05S100</b>		
Single-ended straight female 	PVC	2	<b>252-B3000-25S020</b>	<b>252-B4000-25S020</b>	<b>252-B5000-25S020</b>		
		5	<b>252-B3000-25S050</b>	<b>252-B4000-25S050</b>	<b>252-B5000-25S050</b>		
		10	<b>252-B3000-25S100</b>	<b>252-B4000-25S100</b>	<b>252-B5000-25S100</b>		
	PUR	2	<b>252-B3000-05S020</b>	<b>252-B4000-05S020</b>	<b>252-B5000-05S020</b>		
		5	<b>252-B3000-05S050</b>	<b>252-B4000-05S050</b>	<b>252-B5000-05S050</b>		
		10	<b>252-B3000-05S100</b>	<b>252-B4000-05S100</b>	<b>252-B5000-05S100</b>		
Single-ended angled male 	PVC	2	<b>253-B3000-25S020</b>	<b>253-B4000-25S020</b>	<b>253-B5000-25S020</b>		
		5	<b>253-B3000-25S050</b>	<b>253-B4000-25S050</b>	<b>253-B5000-25S050</b>		
		10	<b>253-B3000-25S100</b>	<b>253-B4000-25S100</b>	<b>253-B5000-25S100</b>		
	PUR	2	<b>253-B3000-05S020</b>	<b>253-B4000-05S020</b>	<b>253-B5000-05S020</b>		
		5	<b>253-B3000-05S050</b>	<b>253-B4000-05S050</b>	<b>253-B5000-05S050</b>		
		10	<b>253-B3000-05S100</b>	<b>253-B4000-05S100</b>	<b>253-B5000-05S100</b>		
Single-ended angled female 	PVC	2	<b>254-B3000-25S020</b>	<b>254-B4000-25S020</b>	<b>254-B5000-25S020</b>		
		5	<b>254-B3000-25S050</b>	<b>254-B4000-25S050</b>	<b>254-B5000-25S050</b>		
		10	<b>254-B3000-25S100</b>	<b>254-B4000-25S100</b>	<b>254-B5000-25S100</b>		
	PUR	2	<b>254-B3000-05S020</b>	<b>254-B4000-05S020</b>	<b>254-B5000-05S020</b>		
		5	<b>254-B3000-05S050</b>	<b>254-B4000-05S050</b>	<b>254-B5000-05S050</b>		
		10	<b>254-B3000-05S100</b>	<b>254-B4000-05S100</b>	<b>254-B5000-05S100</b>		
Straight male mate straight female 	PVC	0.6	<b>256-B3000-25SL60</b>	<b>256-B4000-25SL60</b>	<b>256-B5000-25SL60</b>		
		1.5	<b>256-B3000-25S015</b>	<b>256-B4000-25S015</b>	<b>256-B5000-25S015</b>		
		3	<b>256-B3000-25S030</b>	<b>256-B4000-25S030</b>	<b>256-B5000-25S030</b>		
	PUR	0.6	<b>256-B3000-05SL60</b>	<b>256-B4000-05SL60</b>	<b>256-B5000-05SL60</b>		
		1.5	<b>256-B3000-05S015</b>	<b>256-B4000-05S015</b>	<b>256-B5000-05S015</b>		
		3	<b>256-B3000-05S030</b>	<b>256-B4000-05S030</b>	<b>256-B5000-05S030</b>		
Angled male mate angled female 	PVC	0.6	<b>259-B3000-20SL60</b>	<b>259-B4000-20SL60</b>	<b>259-B5000-20SL60</b>		
		1.5	<b>259-B3000-20S015</b>	<b>259-B4000-20S015</b>	<b>259-B5000-20S015</b>		
		3	<b>259-B3000-20S030</b>	<b>259-B4000-20S030</b>	<b>259-B5000-20S030</b>		
	PUR	0.6	<b>259-B3000-00SL60</b>	<b>259-B4000-00SL60</b>	<b>259-B5000-00SL60</b>		
		1.5	<b>259-B3000-00S015</b>	<b>259-B4000-00S015</b>	<b>259-B5000-00S015</b>		
		3	<b>259-B3000-00S030</b>	<b>259-B4000-00S030</b>	<b>259-B5000-00S030</b>		

The configuration of connectors and the cable length can be customized. For more details, please contact Dinkle  
**Bolded part number is cULus certified.**











## M12 B-Code Molded Connector ( No Shield )

Coding and contacts	Code Contact	B 3		B 4		B 5	
		Male	Female	Male	Female	Male	Female
Rated voltage / current		250V / 4A		250V / 4A		60V / 4A	
Contact arrangement							
Connector style	Cable	Length(m)	Part number				
Single-ended straight male 	PVC	2	<b>201-B3000-20S020</b>	<b>201-B4000-20S020</b>	<b>201-B5000-20S020</b>		
		5	<b>201-B3000-20S050</b>	<b>201-B4000-20S050</b>	<b>201-B5000-20S050</b>		
		10	<b>201-B3000-20S100</b>	<b>201-B4000-20S100</b>	<b>201-B5000-20S100</b>		
	PUR	2	<b>201-B3000-00S020</b>	<b>201-B4000-00S020</b>	<b>201-B5000-00S020</b>		
		5	<b>201-B3000-00S050</b>	<b>201-B4000-00S050</b>	<b>201-B5000-00S050</b>		
		10	<b>201-B3000-00S100</b>	<b>201-B4000-00S100</b>	<b>201-B5000-00S100</b>		
Single-ended straight female 	PVC	2	<b>202-B3000-20S020</b>	<b>202-B4000-20S020</b>	<b>202-B5000-20S020</b>		
		5	<b>202-B3000-20S050</b>	<b>202-B4000-20S050</b>	<b>202-B5000-20S050</b>		
		10	<b>202-B3000-20S100</b>	<b>202-B4000-20S100</b>	<b>202-B5000-20S100</b>		
	PUR	2	<b>202-B3000-00S020</b>	<b>202-B4000-00S020</b>	<b>202-B5000-00S020</b>		
		5	<b>202-B3000-00S050</b>	<b>202-B4000-00S050</b>	<b>202-B5000-00S050</b>		
		10	<b>202-B3000-00S100</b>	<b>202-B4000-00S100</b>	<b>202-B5000-00S100</b>		
Single-ended angled male 	PVC	2	<b>203-B3000-20S020</b>	<b>203-B4000-20S020</b>	<b>203-B5000-20S020</b>		
		5	<b>203-B3000-20S050</b>	<b>203-B4000-20S050</b>	<b>203-B5000-20S050</b>		
		10	<b>203-B3000-20S100</b>	<b>203-B4000-20S100</b>	<b>203-B5000-20S100</b>		
	PUR	2	<b>203-B3000-00S020</b>	<b>203-B4000-00S020</b>	<b>203-B5000-00S020</b>		
		5	<b>203-B3000-00S050</b>	<b>203-B4000-00S050</b>	<b>203-B5000-00S050</b>		
		10	<b>203-B3000-00S100</b>	<b>203-B4000-00S100</b>	<b>203-B5000-00S100</b>		
Single-ended angled female 	PVC	2	<b>204-B3000-20S020</b>	<b>204-B4000-20S020</b>	<b>204-B5000-20S020</b>		
		5	<b>204-B3000-20S050</b>	<b>204-B4000-20S050</b>	<b>204-B5000-20S050</b>		
		10	<b>204-B3000-20S100</b>	<b>204-B4000-20S100</b>	<b>204-B5000-20S100</b>		
	PUR	2	<b>204-B3000-00S020</b>	<b>204-B4000-00S020</b>	<b>204-B5000-00S020</b>		
		5	<b>204-B3000-00S050</b>	<b>204-B4000-00S050</b>	<b>204-B5000-00S050</b>		
		10	<b>204-B3000-00S100</b>	<b>204-B4000-00S100</b>	<b>204-B5000-00S100</b>		
Straight male mate straight female 	PVC	0.6	<b>206-B3000-20SL60</b>	<b>206-B4000-20SL60</b>	<b>206-B5000-20SL60</b>		
		1.5	<b>206-B3000-20S015</b>	<b>206-B4000-20S015</b>	<b>206-B5000-20S015</b>		
		3	<b>206-B3000-20S030</b>	<b>206-B4000-20S030</b>	<b>206-B5000-20S030</b>		
	PUR	0.6	<b>206-B3000-00SL60</b>	<b>206-B4000-00SL60</b>	<b>206-B5000-00SL60</b>		
		1.5	<b>206-B3000-00S015</b>	<b>206-B4000-00S015</b>	<b>206-B5000-00S015</b>		
		3	<b>206-B3000-00S030</b>	<b>206-B4000-00S030</b>	<b>206-B5000-00S030</b>		
Angled male mate angled female 	PVC	0.6	<b>209-B3000-20SL60</b>	<b>209-B4000-20SL60</b>	<b>209-B5000-20SL60</b>		
		1.5	<b>209-B3000-20S015</b>	<b>209-B4000-20S015</b>	<b>209-B5000-20S015</b>		
		3	<b>209-B3000-20S030</b>	<b>209-B4000-20S030</b>	<b>209-B5000-20S030</b>		
	PUR	0.6	<b>209-B3000-00SL60</b>	<b>209-B4000-00SL60</b>	<b>209-B5000-00SL60</b>		
		1.5	<b>209-B3000-00S015</b>	<b>209-B4000-00S015</b>	<b>209-B5000-00S015</b>		
		3	<b>209-B3000-00S030</b>	<b>209-B4000-00S030</b>	<b>209-B5000-00S030</b>		

The configuration of connectors and the cable length can be customized. For more details, please contact Dinkle

**Bolded part number is cULus certified.**

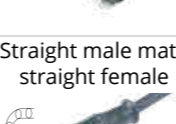
## M12 B-Code Molded Connector ( No Shield, Drag, chain )

Coding and contacts	Code Contact	B 3		B 4		B 5	
		Male	Female	Male	Female	Male	Female
Rated voltage / current		250V / 4A		250V / 4A		60V / 4A	
Contact arrangement							
Connector style	Cable	Length(m)	Part number				
Single-ended straight male 	PUR	2	201-B3000-02S020	201-B4000-02S020	201-B5000-02S020		
		5	201-B3000-02S050	201-B4000-02S050	201-B5000-02S050		
		10	201-B3000-02S100	201-B4000-02S100	201-B5000-02S100		
Single-ended straight female 	PUR	2	202-B3000-02S020	202-B4000-02S020	202-B5000-02S020		
		5	202-B3000-02S050	202-B4000-02S050	202-B5000-02S050		
		10	202-B3000-02S100	202-B4000-02S100	202-B5000-02S100		
Single-ended angled male 	PUR	2	203-B3000-02S020	203-B4000-02S020	203-B5000-02S020		
		5	203-B3000-02S050	203-B4000-02S050	203-B5000-02S050		
		10	203-B3000-02S100	203-B4000-02S100	203-B5000-02S100		
Single-ended angled female 	PUR	2	204-B3000-02S020	204-B4000-02S020	204-B5000-02S020		
		5	204-B3000-02S050	204-B4000-02S050	204-B5000-02S050		
		10	204-B3000-02S100	204-B4000-02S100	204-B5000-02S100		
Straight male mate straight female 	PUR	0.6	206-B3000-02SL60	206-B4000-02SL60	206-B5000-02SL60		
		1.5	206-B3000-02S015	206-B4000-02S015	206-B5000-02S015		
		3	206-B3000-02S030	206-B4000-02S030	206-B5000-02S030		
Angled male mate angled female 	PUR	0.6	209-B3000-02SL60	209-B4000-02SL60	209-B5000-02SL60		
		1.5	209-B3000-02S015	209-B4000-02S015	209-B5000-02S015		
		3	209-B3000-02S030	209-B4000-02S030	209-B5000-02S030		

Cables with drag chain function are guaranteed to withstand 5 million bending times(R=28mm, L=1m, V=1m/s)  
The configuration of connectors and the cable length can be customized. For more details, please contact Dinkle

## M12 B-Code Device Circular Connector

### Front mounting with 0.5m wire

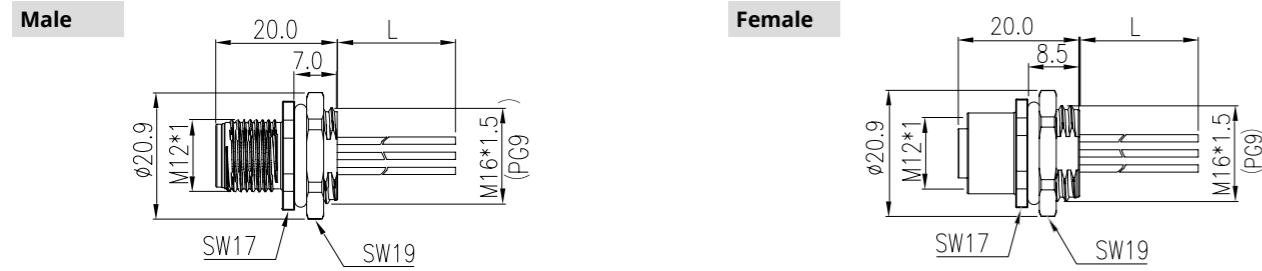

### Front mounting with solder cup pin

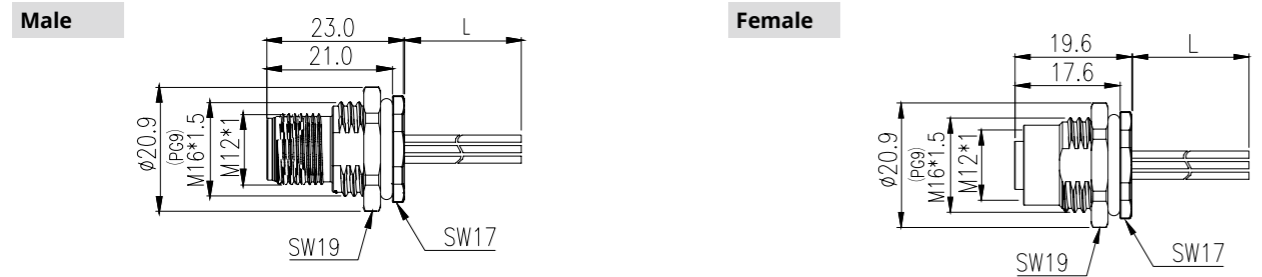

### Rear mounting with 0.5m wire



### Rear mounting with solder pin



### Pin assignments and wire colors

Pin out	3P			4P			5P		
	1	2	3	1	2	3	1	2	3
	Brown	-	Blue	Brown	White	Blue	Brown	White	Blue
	Black	-	-	Black	-	-	Black	-	-
	-	-	-	-	-	-	-	-	Gray

## M12 B-Code Device Connector











Mechanical Properties		Material Properties	
Min. Insertion/withdrawal cycles	100	Contact / contact surface	Copper alloy / Gold plated
Degree of protection	IP67	Contact carrier	PA
Operating Temperature	-40°C ~ 80°C	Hexagonal nut / Outer Shield	Zinc die-cast, nickel-plated
Fasten torque	0.4 Nm	O-ring	NBR
Mounting torque	0.8 Nm	UL94 Flammability rating	V0

Electrical Properties		Cable Information		
Rated voltage / current (contacts)	250VAC / 4A ( $\leq 4$ Pin)	Cable Jacket	Shield	PUR / PVC, BLACK
	60VAC / 4A (5 Pin)		No Shield	PVC
Rated Impulse Voltage	2.5kV ( $\leq 4$ Pin)	UL AWM style	Shield	PUR : UL AWM 20549 / PVC : UL AWM 2464
	1.5kV (5 Pin)		No Shield	PVC : UL AWM 1061
Insulation resistance	Min. 100M $\Omega$	Conductor cross section	0.34mm <sup>2</sup> / 22AWG ( $\leq 4$ Pin)	
Overvoltage Category	II		0.34mm <sup>2</sup> / 22AWG (5 Pin)	
Pollution Degree	3	Material conductor insulation	Shield	PE / PVC
		Flame resistance	Shield	FT-2 / VW-1
		Dielectric strength	Shield	2.0KV/1min

Standards and Regulations	
Design reference	IEC 61076-2-101: Detail specification for M12 connectors with screw-locking
	IEC 60512: Electromechanical components for electronic equipment; basic testing procedure and measuring methods
	IEC 60529: Degree of protection provided by enclosures (IP Code)
Certification reference	UL 2238

**Notice**  
The mechanical and electrical data performance can be ensured when the connector pair is correctly locked and fasten by specified torque. If the connector is not locked and or exposed in th contaminated enviroment, the connector must be sealed by the protective cover. Also, the influences from conductor, cable or PCB assembly must be taken into consideration.

## M12 B-Code Device Connector ( Shield )

Coding and contacts	Code	B		B		B	
	Contact	3		4		5	
Rated voltage / current		250V / 4A		250V / 4A		60V / 4A	
Contact arrangement	Male						
	<b>2m PUR cable</b>						
Connector style	Mount thread	Part number					
	M16 X 1.5	268-B3000-15S020	268-B4000-15S020	268-B5000-15S020			
	Pg9	268-B3002-15S020	268-B4002-15S020	268-B5002-15S020			
	M16 X 1.5	269-B3000-15S020	269-B4000-15S020	269-B5000-15S020			
	Pg9	269-B3002-15S020	269-B4002-15S020	269-B5002-15S020			
	M16 X 1.5	270-B3000-15S020	270-B4000-15S020	270-B5000-15S020			
	Pg9	270-B3002-15S020	270-B4002-15S020	270-B5002-15S020			
	M16 X 1.5	271-B3000-15S020	271-B4000-15S020	271-B5000-15S020			
	Pg9	271-B3002-15S020	271-B4002-15S020	271-B5002-15S020			

The wire length can be customized. For more details, please contact Dinkle

## M12 A-Code Device Connector ( No Shield )

Coding and contacts	Code	B		B		B	
	Contact	3		4		5	
Rated voltage / current		250V / 4A		250V / 4A		60V / 4A	
Contact arrangement	Male						
	<b>Front mounting with 0.5m wire</b>						
Connector style	Mount thread	Part number					
	M16 X 1.5	<b>218-B3000-0VSL50</b>	<b>218-B4000-0VSL50</b>	<b>218-B5000-0VSL50</b>			
	Pg9	<b>218-B3002-0VSL50</b>	<b>218-B4002-0VSL50</b>	<b>218-B5002-0VSL50</b>			
	M16 X 1.5	<b>219-B3000-0VSL50</b>	<b>219-B4000-0VSL50</b>	<b>219-B5000-0VSL50</b>			
	Pg9	<b>219-B3002-0VSL50</b>	<b>219-B4002-0VSL50</b>	<b>219-B5002-0VSL50</b>			
<b>Rear mounting with 0.5m wire</b>							
Connector style	Mount thread	Part number					
	M16 X 1.5	<b>220-B3000-0VSL50</b>	<b>220-B4000-0VSL50</b>	<b>220-B5000-0VSL50</b>			
	Pg9	<b>220-B3002-0VSL50</b>	<b>220-B4002-0VSL50</b>	<b>220-B5002-0VSL50</b>			
	M16 X 1.5	<b>221-B3000-0VSL50</b>	<b>221-B4000-0VSL50</b>	<b>221-B5000-0VSL50</b>			
	Pg9	<b>221-B3002-0VSL50</b>	<b>221-B4002-0VSL50</b>	<b>221-B5002-0VSL50</b>			
<b>Front mounting with solder cup</b>							
Connector style	Mount thread	Part number					
	M16 X 1.5	<b>232-B3000-S</b>	<b>232-B4000-S</b>	<b>232-B5000-S</b>			
	Pg9	<b>232-B3002-S</b>	<b>232-B4002-S</b>	<b>232-B5002-S</b>			
	M16 X 1.5	<b>233-B3000-S</b>	<b>233-B4000-S</b>	<b>233-B5000-S</b>			
	Pg9	<b>233-B3002-S</b>	<b>233-B4002-S</b>	<b>233-B5002-S</b>			
<b>Rear mounting with solder cup</b>							
Connector style	Mount thread	Part number					
	M16 X 1.5	<b>230-B3000-S</b>	<b>230-B4000-S</b>	<b>230-B5000-S</b>			
	Pg9	<b>230-B3002-S</b>	<b>230-B4002-S</b>	<b>230-B5002-S</b>			
	M16 X 1.5	<b>231-B3000-S</b>	<b>231-B4000-S</b>	<b>231-B5000-S</b>			
	Pg9	<b>231-B3002-S</b>	<b>231-B4002-S</b>	<b>231-B5002-S</b>			

The wire length can be customized. For more details, please contact Dinkle

**Bolded part number is cULus certified.**

## M12 B-Code One-piece PCB Circular Connector

### 180° Rear mounting, straight (Shielded)

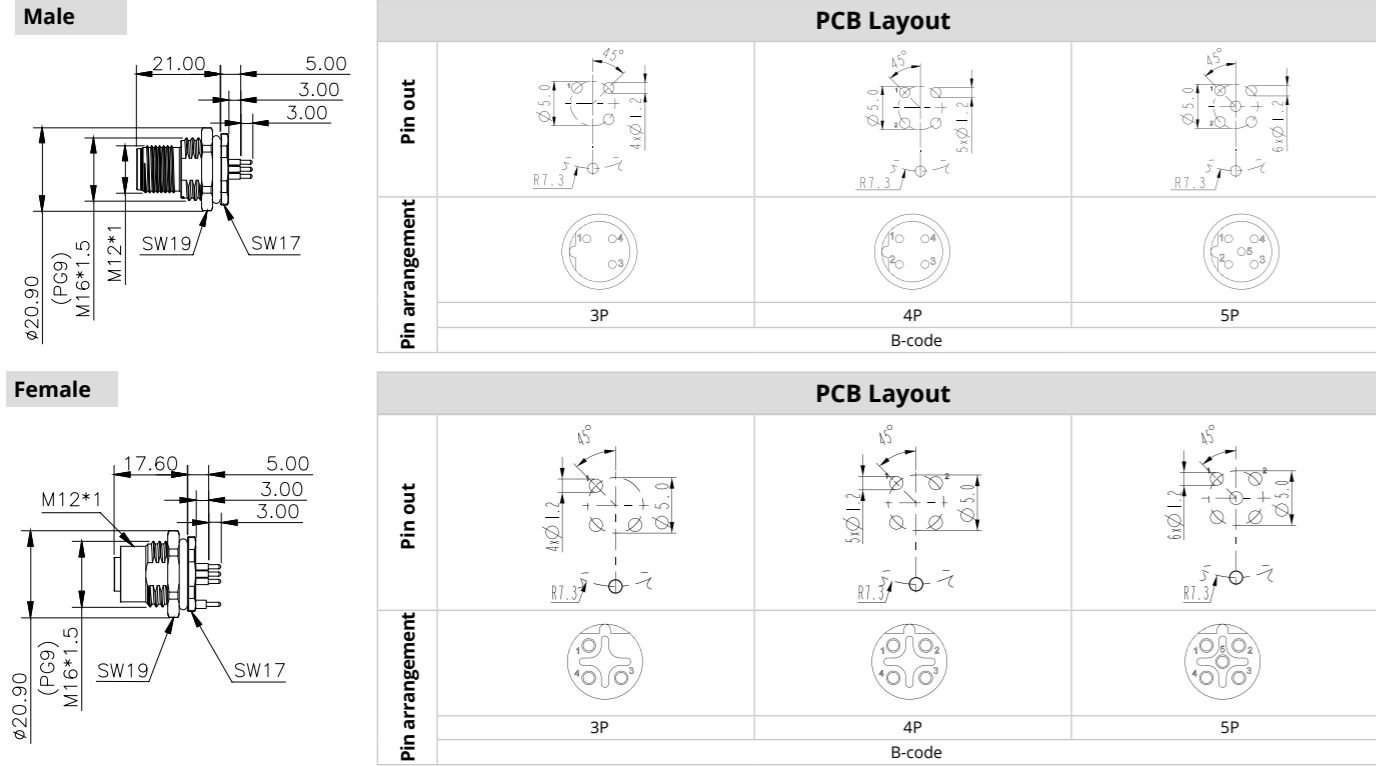

### 180° Rear mounting, straight (NonShielded)

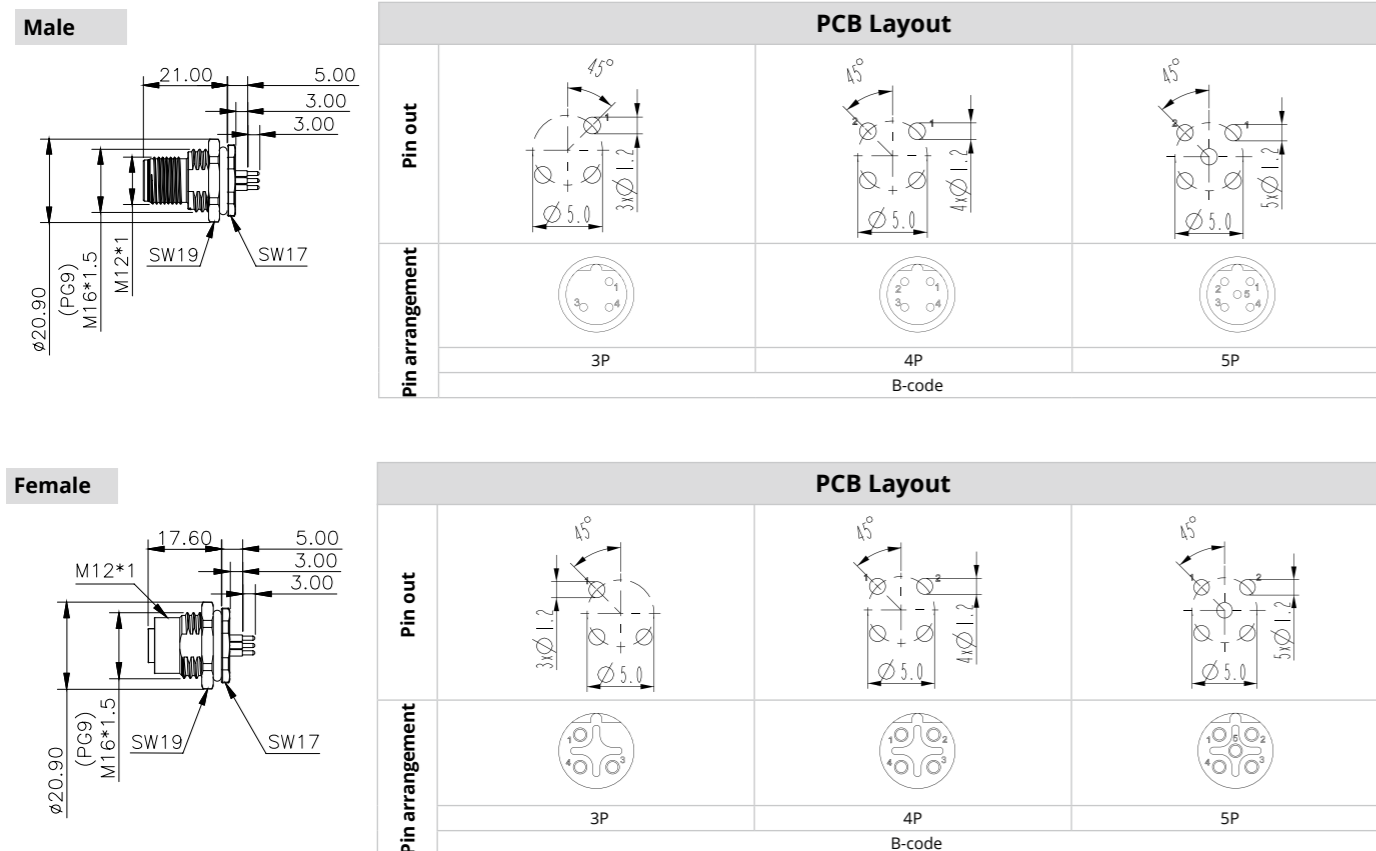

## M12 B-Code One-piece PCB Circular Connector

### 90° Rear mounting, straight (NonShielded)

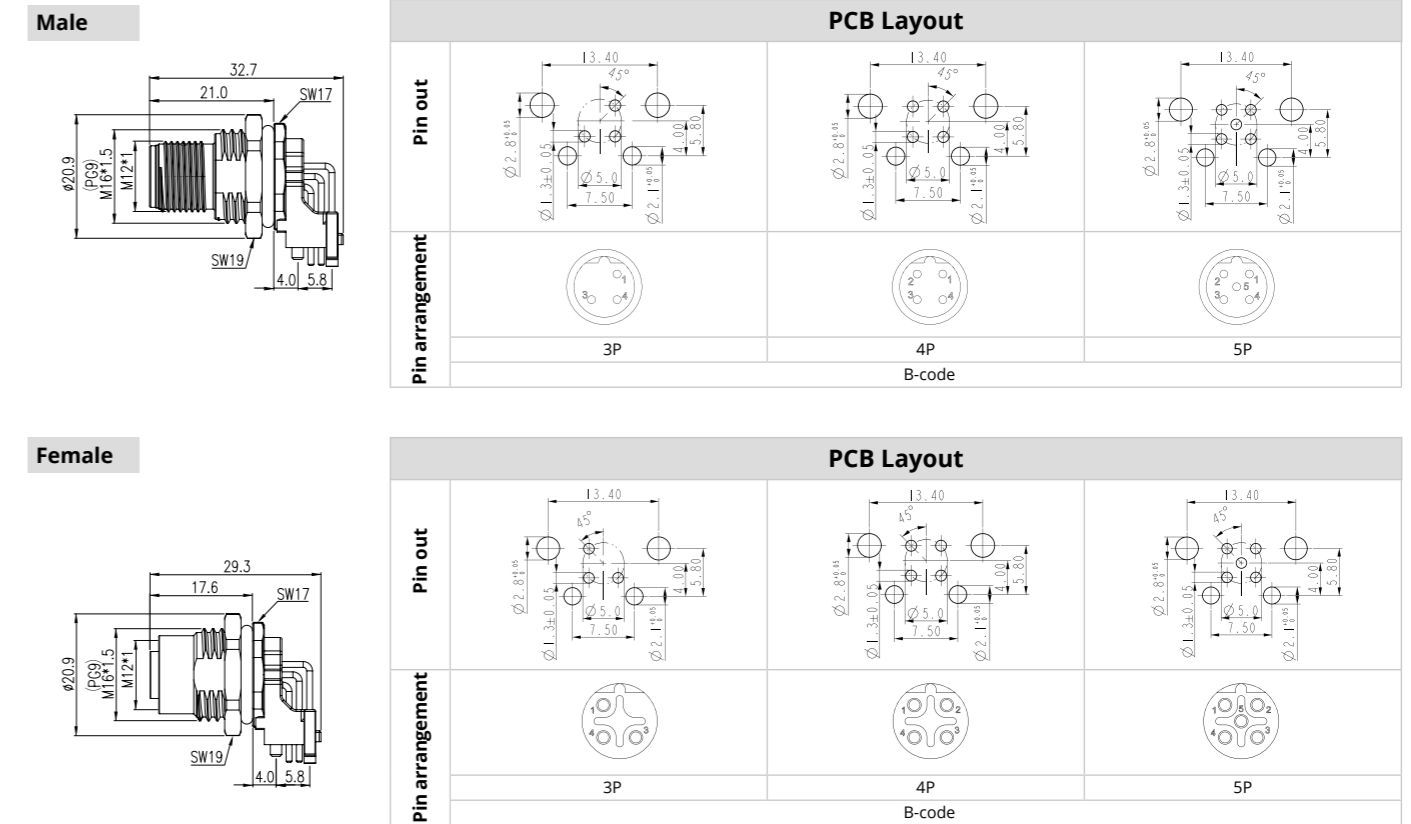

## M12 B-Code One-piece PCB Connector

Mechanical Properties		Material Properties	
Min. Insertion/withdrawal cycles	100	Contact / contact surface	Copper alloy / Gold plated
Degree of protection	IP67	Contact carrier	PA
Operating Temperature	-40°C ~ 80°C	Hexigonal nut / Outer Shield	Zinc die-cast, nickel-plated / Brass, nickel-plated
Fasten torque	0.4 Nm	O-ring	NBR
Soldering method	Wave Soldering	UL94 Flammability rating	V0
Electrical Properties		Cable Information	
Rated voltage / current (contacts)	250VAC / 4A (≤4 Pin)		
	60VAC / 4A (5 Pin)		
Rated Impulse Voltage	2.5kV (≤4 Pin)		
	1.5kV (5 Pin)		
Insulation resistance	Min. 100MΩ		
Overtoltage Category	II		
Pollution Degree	3		
Standards and Regulations			
Design reference	IEC 61076-2-101: Detail specification for M12 connectors with screw-lockin		
	IEC 61076-2-111: Circular connectors - Detail specification for power connectors with M12 screw-locking		
	IEC 60512: Electromechanical components for electronic equipment; basic testing procedure and measuring methods		
Certification reference	IEC 60529: Degree of protection provided by enclosures (IP Code)		
	UL 2238		
Notice			
The mechanical and electrical data performance can be ensured when the connector pair is correctly locked and fasten by specified torque. If the connector is not locked and or exposed in th contaminated enviroment, the connector must be sealed by the protective cover. Also, the influences from conductor, cable or PCB assembly must be taken into consideration.			

## M12 B-Code One-piece PCB Connector ( Shield / No Shield )

Coding and contacts	Code	B		B		B	
	Contact	3		4		5	
Rated voltage / current		250V / 4A		250V / 4A		60V / 4A	
Contact arrangement		Male	Female	Male	Female	Male	Female
							
Rear mounting, straight, Shield							
Connector style	Mount thread	Part number					
Male 	M16 X 1.5	<b>276-B3000-6</b>	<b>276-B4000-6</b>	<b>276-B5000-6</b>			
	Pg9	<b>276-B3002-6</b>	<b>276-B4002-6</b>	<b>276-B5002-6</b>			
Female 	M16 X 1.5	<b>277-B3000-6</b>	<b>277-B4000-6</b>	<b>277-B5000-6</b>			
	Pg9	<b>277-B3002-6</b>	<b>277-B4002-6</b>	<b>277-B5002-6</b>			
Rear mounting, straight, No Shield							
Connector style	Mount thread	Part number					
Male 	M16 X 1.5	<b>226-B3000-6</b>	<b>226-B4000-6</b>	<b>226-B5000-6</b>			
	Pg9	<b>226-B3002-6</b>	<b>226-B4002-6</b>	<b>226-B5002-6</b>			
Female 	M16 X 1.5	<b>227-B3000-6</b>	<b>227-B4000-6</b>	<b>227-B5000-6</b>			
	Pg9	<b>227-B3002-6</b>	<b>227-B4002-6</b>	<b>227-B5002-6</b>			
Rear mounting, angled, No Shield							
Connector style	Mount thread	Part number					
Male 	M16 X 1.5	228-B3000-3	228-B4000-3	228-B5000-3			
	Pg9	228-B3002-3	228-B4002-3	228-B5002-3			
Female 	M16 X 1.5	229-B3000-3	229-B4000-3	229-B5000-3			
	Pg9	229-B3002-3	229-B4002-3	229-B5002-3			

Bolded part number is cULus certified.

## M12 B-Code Two-piece PCB Circular Connector

### 180° Rear mounting, straight (Shielded)

Male

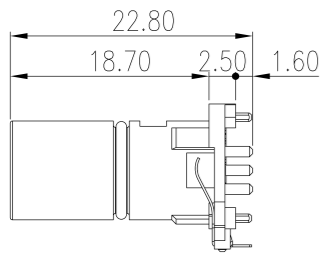

PCB Layout	
Pin out	
Pin arrangement	
	3P                      4P                      5P
	B-code

Female

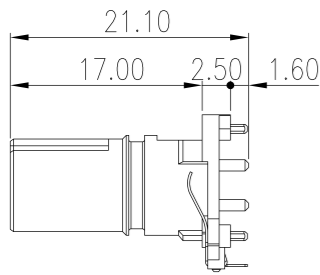

PCB Layout	
Pin out	
Pin arrangement	
	3P                      4P                      5P
	B-code

### 180° Rear mounting, straight (NonShielded)

Male

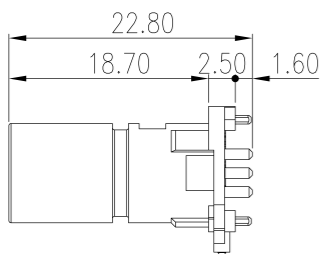

PCB Layout	
Pin out	
Pin arrangement	
	3P                      4P                      5P
	B-code

Female

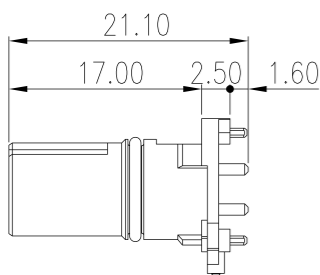

PCB Layout	
Pin out	
Pin arrangement	
	3P                      4P                      5P
	B-code

## M12 B-Code Two-piece PCB Connector

Mechanical Properties		Material Properties	
Min. Insertion/withdrawal cycles	100	Contact / contact surface	Copper alloy / Gold plated
Degree of protection	IP67	Contact carrier	LCP
Operating Temperature	-40°C ~ 125°C	O-ring	SILICONE
Soldering method	THR	Moisture Sensitivity Levels	1
		UL94 Flammability rating	V0
Electrical Properties		Cable Information	
Rated voltage / current (contacts)	250VAC / 4A (≤4 Pin)		
	60VAC / 4A (5 Pin)		
Rated Impulse Voltage	2.5kV (≤4 Pin)		
	1.5kV (5 Pin)		
Insulation resistance	Min. 100MΩ		
Overvoltage Category	II		
Pollution Degree	3		
Standards and Regulations			
Design reference	IEC 61076-2-101: Detail specification for M12 connectors with screw-locking		
	IEC 60512: Electromechanical components for electronic equipment; basic testing procedure and measuring methods		
	IEC 60529: Degree of protection provided by enclosures (IP Code)		
Notice			
The mechanical and electrical data performance can be ensured when the connector pair is correctly locked and fasten by specified torque. If the connector is not locked and or exposed in th contaminated enviroment, the connector must be sealed by the protective cover. Also, the influences from conductor, cable or PCB assembly must be taken into consideration.			

## M12 B-Code Two-piece PCB Connector ( Shield / No Shield )

Coding and contacts	Code	B		B		B	
	Contact	3		4		5	
Rated voltage / current		250V / 4A		250V / 4A		60V / 4A	
Contact arrangement	Male	Female		Male	Female	Male	Female
<b>THR Soldering, straight, shield</b>							
Connector style	package	Part number					
	Tray	281-B3T00S-1	281-B4T00S-1	281-B5T00S-1			
	Tape-and reel	281-B3T00S-2	281-B4T00S-2	281-B5T00S-2			
	Tray	282-B3T00S-1	282-B4T00S-1	282-B5T00S-1			
	Tape-and reel	282-B3T00S-2	282-B4T00S-2	282-B5T00S-2			
<b>THR Soldering, straight, No shield</b>							
Connector style	package	Part number					
	Tray	281-B3T00U-1	281-B4T00U-1	281-B5T00U-1			
	Tape-and reel	281-B3T00U-2	281-B4T00U-2	281-B5T00U-2			
	Tray	282-B3T00U-1	282-B4T00U-1	282-B5T00U-1			
	Tape-and reel	282-B3T00U-2	282-B4T00U-2	282-B5T00U-2			
<b>Metal housing</b>							
Connector style	Mount thread	Part number					
	M15 x 1	283-T1100					
	M15 x 1	284-T1100					

Package unit, Tray : 60 pcs; Tape-and-Reel : 100 pcs

## M12 B-Code Field Attachable Circular Connector

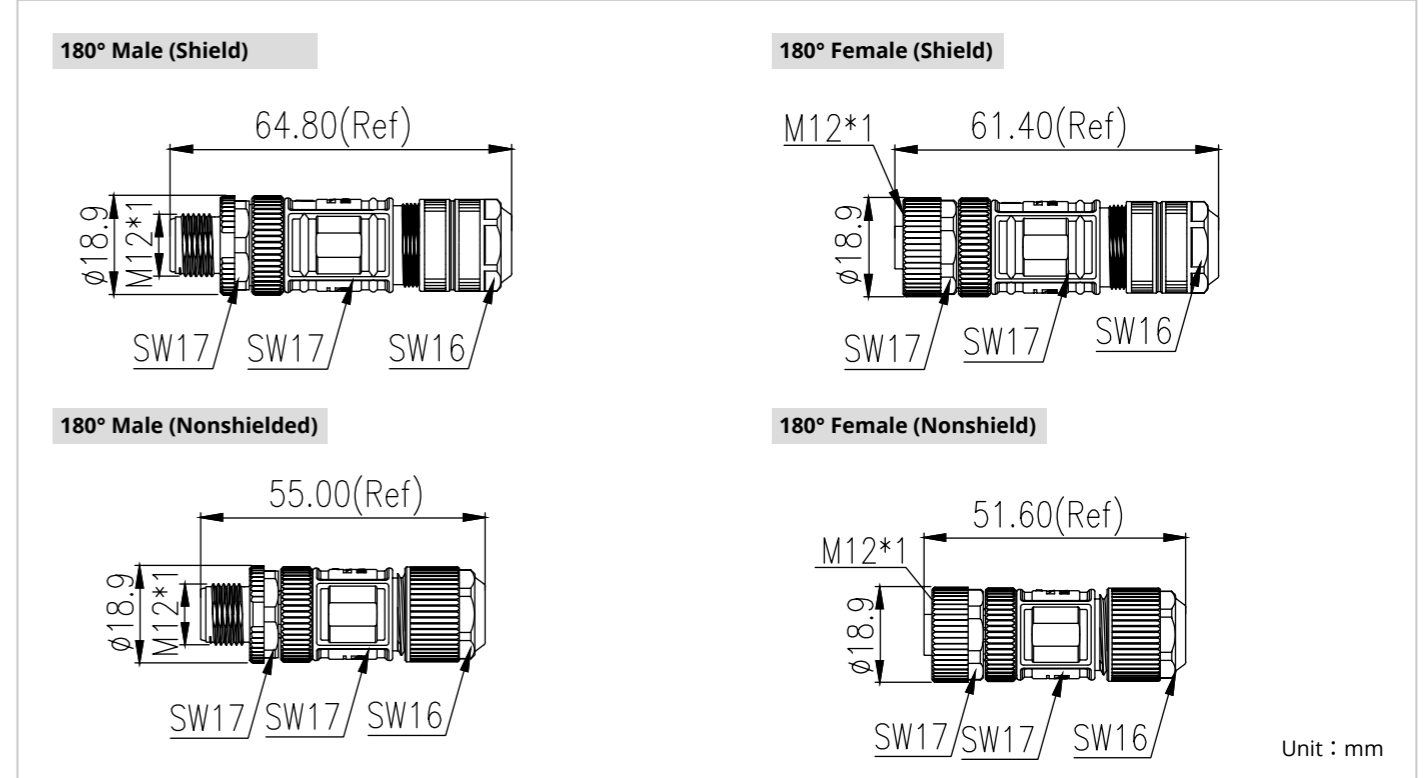

## M12 B-Code Field Attachable Connector

Mechanical Properties		Material Properties	
Min. Insertion/withdrawal cycles	100	Contact / contact surface	Copper alloy / Gold plated
Degree of protection	IP67	Contact carrier / push switch	PA / NA
Operating Temperature	-40°C ~ 85°C	O-ring	NBR
Soldering method	Manual soldering	Outer Shield	PA66 / Zinc die-cast
		UL94 Flammability rating	V0
Electrical Properties		Cable Information	
Rated voltage / current (contacts)	250VAC / 4A (≤4 Pin)	Wiring diameter	18AWG~26AWG
	60VAC / 4A (5 Pin)	Applicable cable diameter	φ4~φ8
Rated Impulse Voltage	2.5kV (≤4 Pin)		
	1.5kV (5 Pin)		
Insulation resistance	Min. 100MΩ		
Overvoltage Category	II		
Pollution Degree	3		
<b>Standards and Regulations</b>			
Design reference	IEC 61076-2-101: Detail specification for M12 connectors with screw-locking IEC 60512: Electromechanical components for electronic equipment; basic testing procedure and measuring methods IEC 60529: Degree of protection provided by enclosures (IP Code)		
Certification reference	UL 2238		

### Notice

The mechanical and electrical data performance can be ensured when the connector pair is correctly locked and fasten by specified torque. If the connector is not locked and or exposed in th contaminated enviroment, the connector must be sealed by the protective cover. Also, the influences from conductor, cable or PCB assembly must be taken into consideration.

## M12 B-Code Field Attachable Connector ( Shield / No Shield )

Coding and contacts	Code	B		B		B	
	Contact	3		4		5	
Rated voltage / current		250V / 4A		250V / 4A		60V / 4A	
Contact arrangement	Male						
	Female						
<b>Shield</b>							
Connector style	Wiring method	Part number					
Male 	Soldering Type	293-B3A1		293-B4A1		293-B5A1	
Female 		294-B3A1		294-B4A1		294-B5A1	
<b>No Shield</b>							
Connector style	Wiring method	Part number					
Male 	Soldering Type	243-B3A0		243-B4A0		243-B5A0	
Female 		244-B3A0		244-B4A0		244-B5A0	



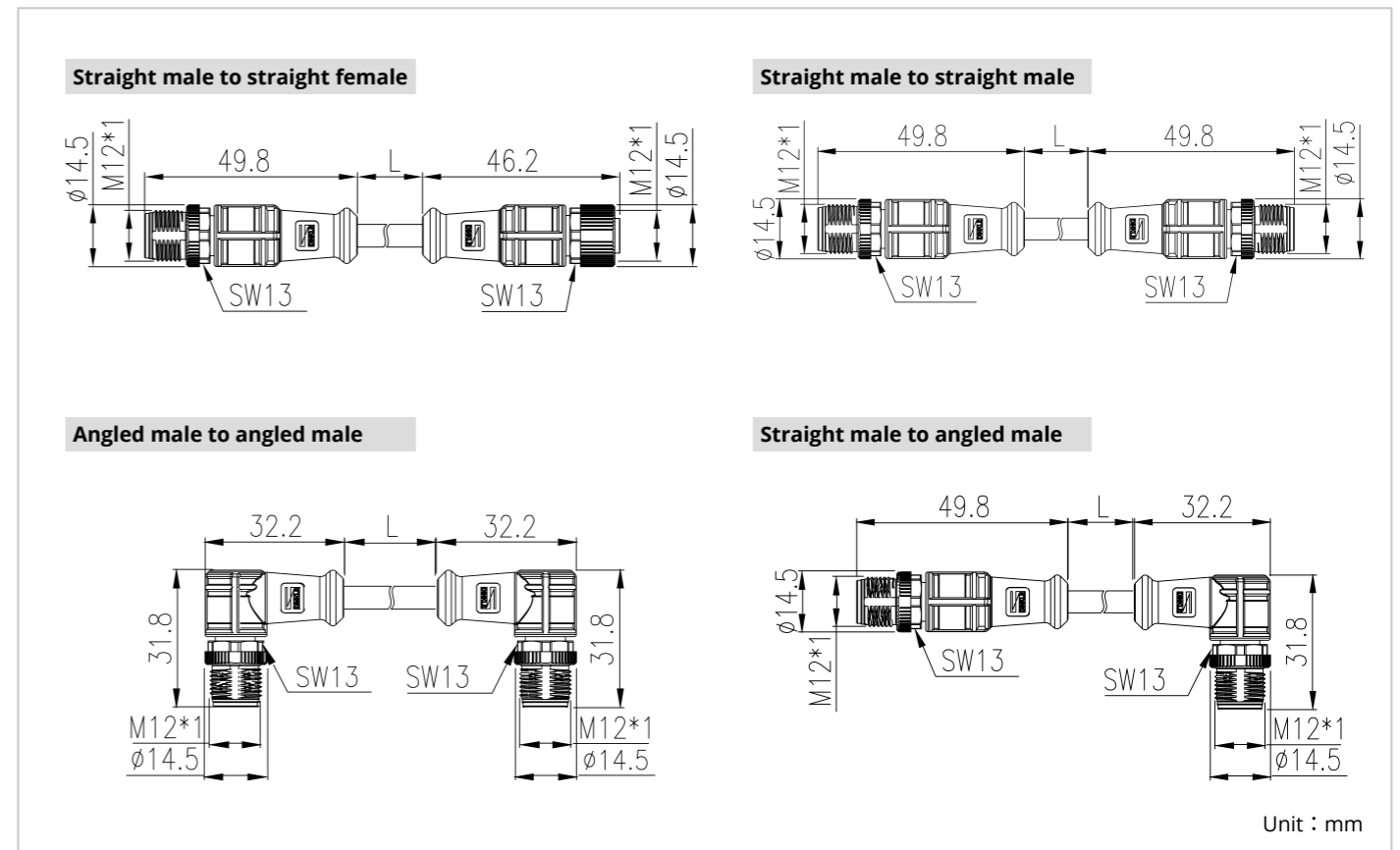
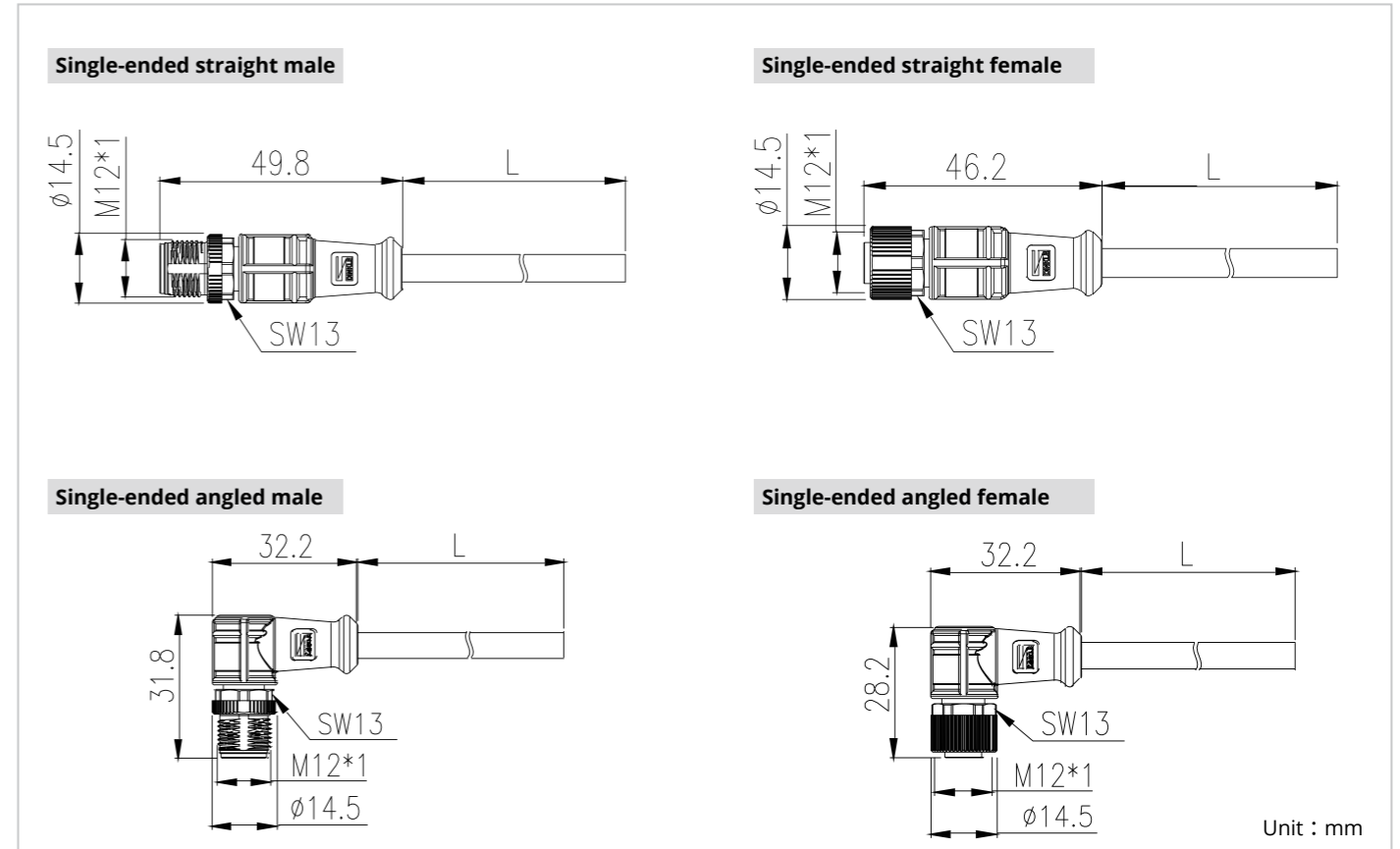

## M12 D-Code Molded Circular Connector



## M12 D-Code Molded Connector









Mechanical Properties		Material Properties	
Min. Insertion/withdrawal cycles	100	Contact / contact surface	Copper alloy / Gold plated
Degree of protection	IP67/IP68	Contact carrier / overmolding	PUR / PUR
Operating Temperature	-40°C ~ 80°C ( Fixed installation )	O-ring	NBR
	-25°C ~ 80°C ( Flexible installation )	Cable gland material	Zinc die-cast, nickel-plated
Fasten torque	0.4 Nm	UL94 Flammability rating	HB
Electrical Properties		Cable Information	
Rated voltage / current (contacts)	250VAC / 4A (≤4 Pin)	Cable Jacket	PUR/PVC, BLACK
		UL AWM style	Shield
No Shield	PUR : UL AWM 20549 / PVC : UL AWM 2464		
Drag chain	PUR : UL AWM 20549		
Rated Impulse Voltage	2.5kV (≤4 Pin)	Conductor cross section	0.34mm <sup>2</sup> /22AWG (≤4 Pin)
Insulation resistance	Min. 100MΩ	Material conductor insulation	PE/PVC
Overvoltage Category	II	Flame resistance	FT-2 / VW-1
Pollution Degree	3	Dielectric strength	2.0KV/1min
Standards and Regulations			
Design reference	IEC 61076-2-101: Detail specification for M12 connectors with screw-locking		
	IEC 60512: Electromechanical components for electronic equipment; basic testing procedure and measuring methods		
	IEC 60529: Degree of protection provided by enclosures (IP Code)		
Certification reference	UL 2238		
Notice			
The mechanical and electrical data performance can be ensured when the connector pair is correctly locked and fasten by specified torque. If the connector is not locked and or exposed in th contaminated enviroment, the connector must be sealed by the protective cover. Also, the influences from conductor, cable or PCB assembly must be taken into consideration.			

## M12 D-Code Molded Connector ( Shield )

Coding and contacts		Code	D	
		Contact	4	
Rated voltage / current		250V / 4A		
Contact arrangement		Male	Female	
				
Connector style	Cable	Length(m)	Part number	
	PVC	2	<b>251-D4000-25S020</b>	
		5	<b>251-D4000-25S050</b>	
		10	<b>251-D4000-25S100</b>	
	PUR	2	<b>251-D4000-05S020</b>	
		5	<b>251-D4000-05S050</b>	
		10	<b>251-D4000-05S100</b>	
	PVC	2	<b>252-D4000-25S020</b>	
		5	<b>252-D4000-25S050</b>	
		10	<b>252-D4000-25S100</b>	
	PUR	2	<b>252-D4000-05S020</b>	
		5	<b>252-D4000-05S050</b>	
		10	<b>252-D4000-05S100</b>	
	PVC	2	<b>253-D4000-25S020</b>	
		5	<b>253-D4000-25S050</b>	
		10	<b>253-D4000-25S100</b>	
	PUR	2	<b>253-D4000-05S020</b>	
		5	<b>253-D4000-05S050</b>	
		10	<b>253-D4000-05S100</b>	
	PVC	2	<b>254-D4000-25S020</b>	
		5	<b>254-D4000-25S050</b>	
		10	<b>254-D4000-25S100</b>	
	PUR	2	<b>254-D4000-05S020</b>	
		5	<b>254-D4000-05S050</b>	
		10	<b>254-D4000-05S100</b>	
	PVC	0.6	<b>256-D4000-25SL60</b>	
		1.5	<b>256-D4000-25S015</b>	
		3	<b>256-D4000-25S030</b>	
	PUR	0.6	<b>256-D4000-05SL60</b>	
		1.5	<b>256-D4000-05S015</b>	
		3	<b>256-D4000-05S030</b>	
	PVC	0.6	<b>259-D4000-25SL60</b>	
		1.5	<b>259-D4000-25S015</b>	
		3	<b>259-D4000-25S030</b>	
	PUR	0.6	<b>259-D4000-05SL60</b>	
		1.5	<b>259-D4000-05S015</b>	
		3	<b>259-D4000-05S030</b>	

The configuration of connectors and the cable length can be customized. For more details, please contact Dinkle  
**Bolded part number is cULus certified.**



## M12 D-Code Molded Connector ( No Shield )

Coding and contacts		Code	D	
Contact		4	250V / 4A	
Rated voltage / current				
Contact arrangement		Male	Female	
				
Connector style	Cable	Length(m)	Part number	
	PVC	2	<b>201-D4000-20S020</b>	
		5	<b>201-D4000-20S050</b>	
		10	<b>201-D4000-20S100</b>	
	PUR	2	<b>201-D4000-00S020</b>	
		5	<b>201-D4000-00S050</b>	
		10	<b>201-D4000-00S100</b>	
	PVC	2	<b>202-D4000-20S020</b>	
		5	<b>202-D4000-20S050</b>	
		10	<b>202-D4000-20S100</b>	
	PUR	2	<b>202-D4000-00S020</b>	
		5	<b>202-D4000-00S050</b>	
		10	<b>202-D4000-00S100</b>	
	PVC	2	<b>203-D4000-20S020</b>	
		5	<b>203-D4000-20S050</b>	
		10	<b>203-D4000-20S100</b>	
	PUR	2	<b>203-D4000-00S020</b>	
		5	<b>203-D4000-00S050</b>	
		10	<b>203-D4000-00S100</b>	
	PVC	2	<b>204-D4000-20S020</b>	
		5	<b>204-D4000-20S050</b>	
		10	<b>204-D4000-20S100</b>	
	PUR	2	<b>204-D4000-00S020</b>	
		5	<b>204-D4000-00S050</b>	
		10	<b>204-D4000-00S100</b>	
	PVC	0.6	<b>206-D4000-20SL60</b>	
		1.5	<b>206-D4000-20S015</b>	
		3	<b>206-D4000-20S030</b>	
	PUR	0.6	<b>206-D4000-00SL60</b>	
		1.5	<b>206-D4000-00S015</b>	
		3	<b>206-D4000-00S030</b>	
	PVC	0.6	<b>209-D4000-20SL60</b>	
		1.5	<b>209-D4000-20S015</b>	
		3	<b>209-D4000-20S030</b>	
	PUR	0.6	<b>209-D4000-00SL60</b>	
		1.5	<b>209-D4000-00S015</b>	
		3	<b>209-D4000-00S030</b>	

The configuration of connectors and the cable length can be customized. For more details, please contact Dinkle

**Bolded part number is cULus certified.**

## M12 D-Code Molded Connector ( No Shield, Drag, chain )

Coding and contacts		Code	D	
Contact		4	250V / 4A	
Rated voltage / current				
Contact arrangement		Male	Female	
				
Connector style	Cable	Length(m)	Part number	
	PUR	2	201-D4000-02S020	
		5	201-D4000-02S050	
		10	201-D4000-02S100	
	PUR	2	202-D4000-02S020	
		5	202-D4000-02S050	
		10	202-D4000-02S100	
	PUR	2	203-D4000-02S020	
		5	203-D4000-02S050	
		10	203-D4000-02S100	
	PUR	2	204-D4000-02S020	
		5	204-D4000-02S050	
		10	204-D4000-02S100	
	PUR	0.6	206-D4000-02SL60	
		1.5	206-D4000-02S015	
		3	206-D4000-02S030	
	PUR	0.6	209-D4000-02SL60	
		1.5	209-D4000-02S015	
		3	209-D4000-02S030	

Cables with drag chain function are guaranteed to withstand 5 million bending times(R=28mm, L=1m, V=1m/s)  
The configuration of connectors and the cable length can be customized. For more details, please contact Dinkle

## M12 D-Code Device Circular Connector

### Front mounting with 0.5m wire

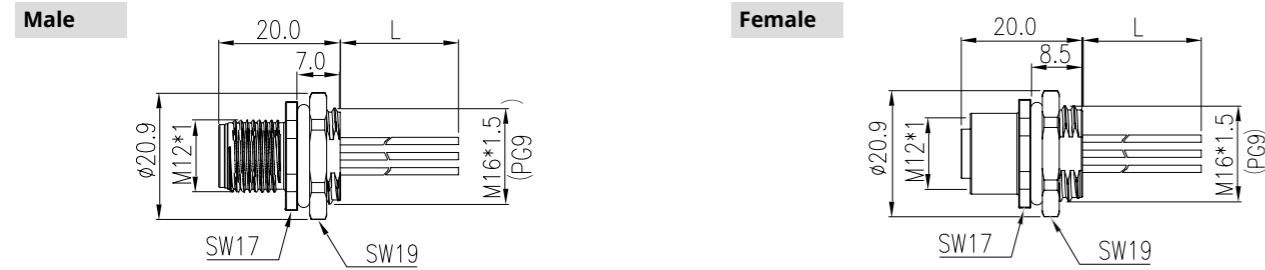

### Front mounting with solder cup pin

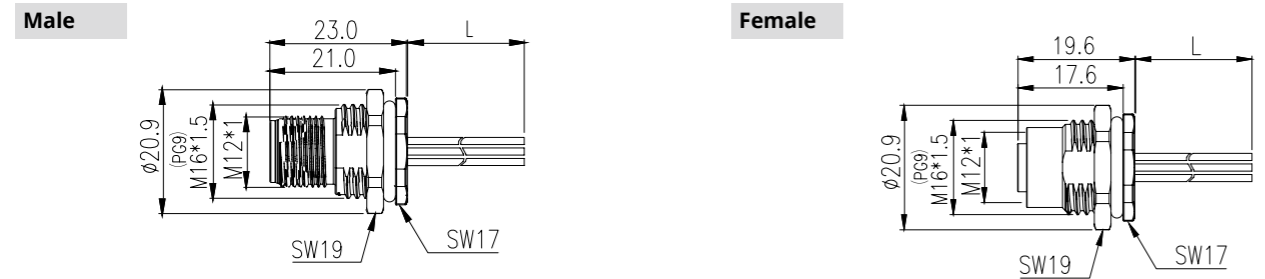

### Rear mounting with 0.5m wire



### Rear mounting with solder cup pin



### Pin assignments and wire colors

Pin arrangement		
	4P	
D code		
Pin out	1	Yellow
	2	White
	3	Orange
	4	Blue

## M12 D-Code Device Connector

Mechanical Properties		Material Properties	
Min. Insertion/withdrawal cycles	100	Contact / contact surface	Copper alloy / Gold plated
Degree of protection	IP67	Contact carrier	PA
Operating Temperature	-40°C ~ 80°C	Hexigonal nut / Outer Shield	Zinc die-cast, nickel-plated
Fasten torque	0.4 Nm	O-ring	NBR
Mounting torque	0.8 Nm	UL94 Flammability rating	V0







Electrical Properties		Cable Information		
Rated voltage / current (contacts)	30VAC / 4A (≤4 Pin)	Cable Jacket	Shield	PUR, BLUE
			No Shield	PVC
Rated Impulse Voltage	2.5kV (≤4 Pin)	UL AWM style	Shield	PUR : UL20963
			No Shield	PVC : UL 1061
Insulation resistance	Min. 100MΩ	Conductor cross section	Shield	0.14mm <sup>2</sup> / 26AWG (≤4 Pin)
			No Shield	0.34mm <sup>2</sup> / 22AWG (≤4 Pin)
Overvoltage Category	II	Material conductor insulation	Shield	HD-PE
Pollution Degree	3		Flame resistance	Shield
		Dielectric strength	Shield	1.0KV/1min DC

Standards and Regulations	
Design reference	IEC 61076-2-101: Detail specification for M12 connectors with screw-locking
	IEC 60512: Electromechanical components for electronic equipment; basic testing procedure and measuring methods
	IEC 60529: Degree of protection provided by enclosures (IP Code)
Certification reference	UL 2238

**Notice**











The mechanical and electrical data performance can be ensured when the connector pair is correctly locked and fasten by specified torque. If the connector is not locked and or exposed in th contaminated enviroment, the connector must be sealed by the protective cover. Also, the influences from conductor, cable or PCB assembly must be taken into consideration.

## M12 D-Code Device Connector ( Shield )

Coding and contacts	Code	D	
	Contact	4	
Rated voltage / current	250V / 4A		
Contact arrangement	Male	Female	
			
<b>2m PUR cable</b>			
Connector style	Mount thread	Part number	
 Male	M16 X 1.5	268-D4000-15S020	
	Pg9	268-D4002-15S020	
 Female	M16 X 1.5	269-D4000-15S020	
	Pg9	269-D4002-15S020	
 Male	M16 X 1.5	270-D4000-15S020	
	Pg9	270-D4002-15S020	
 Female	M16 X 1.5	271-D4000-15S020	
	Pg9	271-D4002-15S020	

The wire length can be customized. For more details, please contact Dinkle

## M12 D-Code Device Connector ( No Shield )

Coding and contacts	Code	D	
	Contact	4	
Rated voltage / current	250V / 4A		
Contact arrangement	Male	Female	
			
<b>Front mounting with 0.5m wire</b>			
Connector style	Mount thread	Part number	
 Male	M16 X 1.5	<b>218-D4000-0VSL50</b>	
	Pg9	<b>218-D4002-0VSL50</b>	
 Female	M16 X 1.5	<b>219-D4000-0VSL50</b>	
	Pg9	<b>219-D4002-0VSL50</b>	
<b>Rear mounting with 0.5m wire</b>			
Connector style	Mount thread	Part number	
 Male	M16 X 1.5	<b>220-D4000-0VSL50</b>	
	Pg9	<b>220-D4002-0VSL50</b>	
 Female	M16 X 1.5	<b>221-D4000-0VSL50</b>	
	Pg9	<b>221-D4002-0VSL50</b>	
<b>Front mounting with solder cup</b>			
Connector style	Mount thread	Part number	
 Male	M16 X 1.5	<b>232-D4000-S</b>	
	Pg9	<b>232-D4002-S</b>	
 Female	M16 X 1.5	<b>233-D4000-S</b>	
	Pg9	<b>233-D4002-S</b>	
<b>Rear mounting with solder cup</b>			
Connector style	Mount thread	Part number	
 Male	M16 X 1.5	<b>230-D4000-S</b>	
	Pg9	<b>230-D4002-S</b>	
 Female	M16 X 1.5	<b>231-D4000-S</b>	
	Pg9	<b>231-D4002-S</b>	

The wire length can be customized. For more details, please contact Dinkle  
**Bolded part number is cULus certified.**

## M12 D-Code One-piece PCB Circular Connector

### 180° Rear mounting, straight (Shielded)

Male		PCB Layout	
	Pin out		
	Pin arrangement		4P D- code
Female		PCB Layout	
	Pin out		
	Pin arrangement		4P D- code

### 180° Rear mounting, straight (NonShielded)

Male		PCB Layout	
	Pin out		
	Pin arrangement		4P D- code
Female		PCB Layout	
	Pin out		
	Pin arrangement		4P D- code

## M12 D-Code One-piece PCB Circular Connector









### 90° Rear mounting, straight (NonShielded)

Male		PCB Layout	
	Pin out		
	Pin arrangement		4P D- code
Female		PCB Layout	
	Pin out		
	Pin arrangement		4P D- code

## M12 D-Code One-piece PCB Connector

Mechanical Properties		Material Properties	
Min. Insertion/withdrawal cycles	100	Contact / contact surface	Copper alloy / Gold plated
Degree of protection	IP67	Contact carrier	PA
Operating Temperature	-40°C ~ 80°C	Hexagonal nut / Outer Shield	Zinc die-cast, nickel-plated / Brass, nickel-plated
Fasten torque	0.4 Nm	O-ring	NBR
Soldering method	Wave Soldering	UL94 Flammability rating	V0
Electrical Properties		Cable Information	
Rated voltage / current (contacts)	250VAC / 4A (≤4 Pin)		
Rated Impulse Voltage	2.5kV (≤4 Pin)		
Insulation resistance	Min. 100MΩ		
Overvoltage Category	II		
Pollution Degree	3		
Standards and Regulations			
Design reference	IEC 61076-2-101: Detail specification for M12 connectors with screw-locking IEC 61076-2-111: Circular connectors - Detail specification for power connectors with M12 screw-locking IEC 60512: Electromechanical components for electronic equipment; basic testing procedure and measuring methods IEC 60529: Degree of protection provided by enclosures (IP Code)		
Certification reference	UL 2238		
Notice			
The mechanical and electrical data performance can be ensured when the connector pair is correctly locked and fasten by specified torque. If the connector is not locked and or exposed in th contaminated enviroment, the connector must be sealed by the protective cover. Also, the influences from conductor, cable or PCB assembly must be taken into consideration.			

## M12 D-Code One-piece PCB Connector ( Shield / No Shield )

Coding and contacts	Code	D	
	Contact	4	
Rated voltage / current		250V / 4A	
Contact arrangement		Male 	Female 
Rear mounting, straight, Shield			
Connector style	Mount thread	Part number	
Male 	M16 X 1.5	<b>276-D4000-6</b>	
	Pg9	<b>276-D4002-6</b>	
Female 	M16 X 1.5	<b>277-D4000-6</b>	
	Pg9	<b>277-D4002-6</b>	
Rear mounting, straight, No Shield			
Connector style	Mount thread	Part number	
Male 	M16 X 1.5	<b>226-D4000-6</b>	
	Pg9	<b>226-D4002-6</b>	
Female 	M16 X 1.5	<b>227-D4000-6</b>	
	Pg9	<b>227-D4002-6</b>	
Rear mounting, angled, No Shield			
Connector style	Mount thread	Part number	
Male 	M16 X 1.5	228-D4000-3	
	Pg9	228-D4002-3	
Female 	M16 X 1.5	229-D4000-3	
	Pg9	229-D4002-3	

**Bolded part number is cULus certified.**

## M12 D-Code Two-piece PCB Circular Connector

### 180° Rear mounting, straight (Shielded)

Male		PCB Layout	
	Pin out		
	Pin arrangement	 4P D-code	

Female		PCB Layout	
	Pin out		
	Pin arrangement	 4P D-code	

### 180° Rear mounting, straight (NonShielded)

Male		PCB Layout	
	Pin out		
	Pin arrangement	 4P D-code	

Female		PCB Layout	
	Pin out		
	Pin arrangement	 4P D-code	

## M12 D-Code Two-piece PCB Connector

Mechanical Properties		Material Properties	
Min. Insertion/withdrawal cycles	100	Contact / contact surface	Copper alloy / Gold plated
Degree of protection	IP67	Contact carrier	LCP
Operating Temperature	-40°C ~ 125°C	O-ring	SILICONE
Soldering method	THR / SMT	Moisture Sensitivity Levels	1
		UL94 Flammability rating	V0









Electrical Properties		Cable Information	
Rated voltage / current (contacts)	250VAC / 4A (4 Pin)		
Rated Impulse Voltage	2.5kV (4 Pin)		
Insulation resistance	Min. 100MΩ		
Overvoltage Category	II		
Pollution Degree	3		

Standards and Regulations	
Design reference	IEC 61076-2-101: Detail specification for M12 connectors with screw-locking IEC 60512: Electromechanical components for electronic equipment; basic testing procedure and measuring methods IEC 60529: Degree of protection provided by enclosures (IP Code)

**Notice**

The mechanical and electrical data performance can be ensured when the connector pair is correctly locked and fasten by specified torque. If the connector is not locked and or exposed in th contaminated enviroment, the connector must be sealed by the protective cover. Also, the influences from conductor, cable or PCB assembly must be taken into consideration.

## M12 D-Code Two-piece PCB Connector ( Shield / No Shield )

Coding and contacts	Code	D	
	Contact	4	
Rated voltage / current		30V / 2A	
Contact arrangement		Male 	Female 
<b>THR Soldering, straight, shield</b>			
Connector style	package	Part number	
	Tray	281-D4T00S-1	
	Tape-and reel	281-D4T00S-2	
	Tray	282-D4T00S-1	
	Tape-and reel	282-D4T00S-2	
<b>THR Soldering, straight, No shield</b>			
Connector style	package	Part number	
	Tray	281-D4T00U-1	
	Tape-and reel	281-D4T00U-2	
	Tray	282-D4T00U-1	
	Tape-and reel	282-D4T00U-2	
<b>SMT Soldering, straight, No shield</b>			
Connector style	package	Part number	
	Tray	282-D4S00U-1	
	Tape-and reel	282-D4S00U-2	
<b>Metal housing</b>			
Connector style	Mount thread	Part number	
	M15 x 1	283-T1100	
	Female use 	M15 x 1	284-T1100

Package unit, Tray : 60 pcs; Tape-and-Reel : 100 pcs

## M12 D-Code Field Attachable Circular Connector

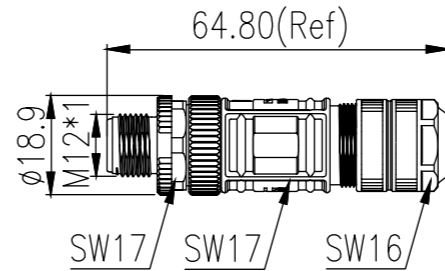
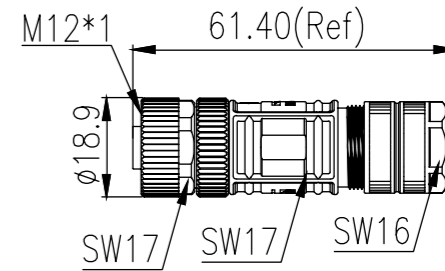
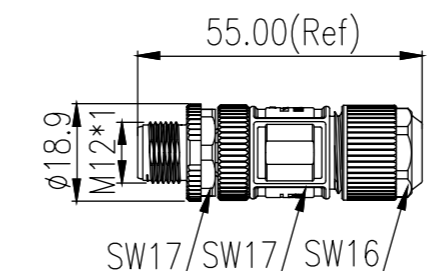
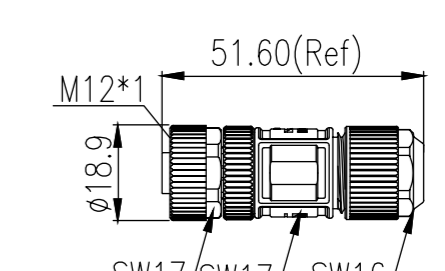
<b>180° Male (Shield)</b> 	<b>180° Female (Shield)</b> 
<b>180° Male (Nonshielded)</b> 	<b>180° Female (Nonshielded)</b> 

Unit : mm

## M12 D-Code Field Attachable Connector

Mechanical Properties		Material Properties	
Min. Insertion/withdrawal cycles	100	Contact / contact surface	Copper alloy / Gold plated
Degree of protection	IP67	Contact carrier / push switch	PA / NA
Operating Temperature	-40°C ~ 125°C	O-ring	NBR
Soldering method	Manual soldering	Outer Shield	PA66 / Zinc die-cast
		UL94 Flammability rating	V0
Electrical Properties		Cable Information	
Rated voltage / current (contacts)	250VAC / 4A (4 Pin)	Wiring diameter	18AWG~26AWG
Rated Impulse Voltage	2.5kV (4 Pin)	Applicable cable diameter	φ4~φ8
Insulation resistance	Min. 100MΩ		
Overvoltage Category	II		
Pollution Degree	3		
Standards and Regulations			
Design reference	IEC 61076-2-101: Detail specification for M12 connectors with screw-locking IEC 60512: Electromechanical components for electronic equipment; basic testing procedure and measuring methods IEC 60529: Degree of protection provided by enclosures (IP Code)		
Certification reference	UL 2238		

### Notice

The mechanical and electrical data performance can be ensured when the connector pair is correctly locked and fasten by specified torque. If the connector is not locked and or exposed in th contaminated enviroment, the connector must be sealed by the protective cover. Also, the influences from conductor, cable or PCB assembly must be taken into consideration.

## M12 D-Code Field Attachable Connector ( Shield / No Shield )

Coding and contacts	Code	<b>D</b>	
	Contact	<b>4</b>	
Rated voltage / current		250V / 4A	
Contact arrangement		Male	Female
			
<b>Shield</b>			
Connector style	Wiring method	Part number	
Male 	Soldering Type	293-D4A1	
Female 		294-D4A1	
<b>No Shield</b>			
Connector style	Wiring method	Part number	
Male 	Soldering Type	243-D4A0	
Female 		244-D4A0	



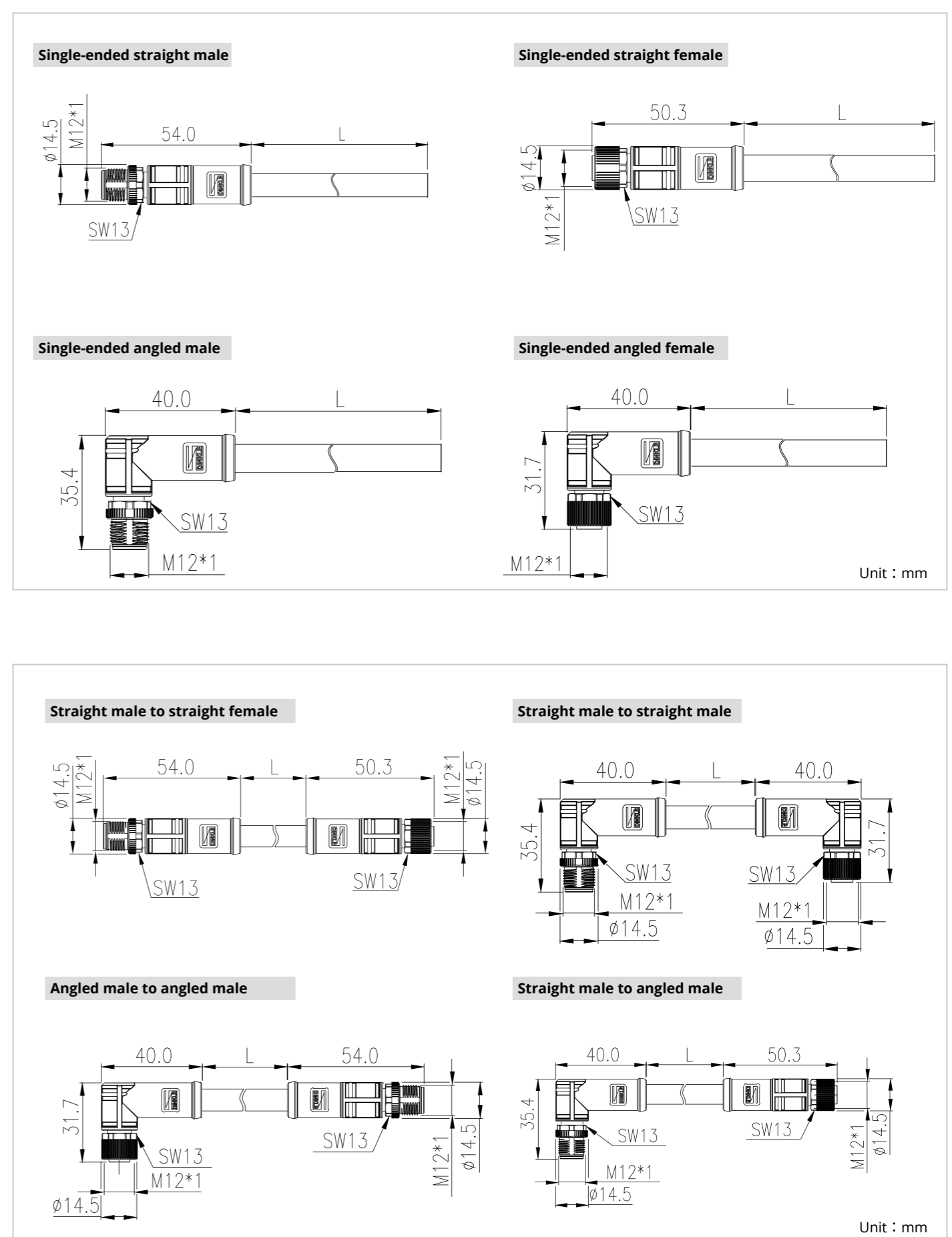





## M12 S-Code Molded Circular Connector



## M12 S-Code Molded Connector

Mechanical Properties		Material Properties	
Min. Insertion/withdrawal cycles	100	Contact / contact surface	Copper alloy / Gold plated
Degree of protection	IP67	Contact carrier / overmolding	PUR / PP
Operating Temperature	-40°C ~ 80°C ( Fixed installation )	O-ring	NBR
	-25°C ~ 80°C ( Flexible installation )	Cable gland material	Zinc die-cast, nickel-plated
Fasten torque	0.4 Nm	UL94 Flammability rating	V0
Electrical Properties		Cable Information	
Rated voltage / current (contacts)	630VAC / 16A (3 Pin)	Cable Jacket	PUR, BLACK
	630VAC / 12A (4 Pin)	UL AWM style	No Shield   PUR : UL AWM 20234
Rated Impulse Voltage	6kV (3 Pin)	Conductor cross section	1.5mm <sup>2</sup> /16AWG (3 Pin)
	6kV (4 Pin)		1.5mm <sup>2</sup> /16AWG (4 Pin)
Insulation resistance	Min. 100MΩ	Material conductor insulation	PP
Overvoltage Category	III	Flame resistance	VW-1/FT1
Pollution Degree	3	Dielectric strength	4.0KV/1min
Standards and Regulations			
Design reference	IEC 61076-2-111: Circular connectors - Detail specification for power connectors with M12 screw-locking		
	IEC 60512: Electromechanical components for electronic equipment; basic testing procedure and measuring methods		
	IEC 60529: Degree of protection provided by enclosures (IP Code)		
Certification reference	UL 2237		
Notice			
The mechanical and electrical data performance can be ensured when the connector pair is correctly locked and fasten by specified torque. If the connector is not locked and or exposed in th contaminated enviroment, the connector must be sealed by the protective cover. Also, the influences from conductor, cable or PCB assembly must be taken into consideration.			

## M12 S-Code Molded Connector ( No Shield )

Coding and contacts	Code	S		S	
	Contact	3(2+PE)		4(3+PE)	
Rated voltage / current		630V / 16A		630V / 12A	
Contact arrangement		Male 	Female 	Male 	Female 
Connector style	Cable	Length(m)	Part number		
 Single-ended straight male	PUR	2	<b>201-S3303-02S020</b>	<b>201-S4303-02S020</b>	
		5	<b>201-S3303-02S050</b>	<b>201-S4303-02S050</b>	
		10	<b>201-S3303-02S100</b>	<b>201-S4303-02S100</b>	
 Single-ended straight female	PUR	2	<b>202-S3303-02S020</b>	<b>202-S4303-02S020</b>	
		5	<b>202-S3303-02S050</b>	<b>202-S4303-02S050</b>	
		10	<b>202-S3303-02S100</b>	<b>202-S4303-02S100</b>	
 Single-ended angled male	PUR	2	<b>203-S3303-02S020</b>	<b>203-S4303-02S020</b>	
		5	<b>203-S3303-02S050</b>	<b>203-S4303-02S050</b>	
		10	<b>203-S3303-02S100</b>	<b>203-S4303-02S100</b>	
 Single-ended angled female	PUR	2	<b>204-S3303-02S020</b>	<b>204-S4303-02S020</b>	
		5	<b>204-S3303-02S050</b>	<b>204-S4303-02S050</b>	
		10	<b>204-S3303-02S100</b>	<b>204-S4303-02S100</b>	
 Straight male mate straight female	PUR	0.6	<b>206-S3303-02SL60</b>	<b>206-S4303-02SL60</b>	
		1.5	<b>206-S3303-02S015</b>	<b>206-S4303-02S015</b>	
		3	<b>206-S3303-02S030</b>	<b>206-S4303-02S030</b>	
 Angled male mate angled female	PUR	0.6	<b>209-S3303-02SL60</b>	<b>209-S4303-02SL60</b>	
		1.5	<b>209-S3303-02S015</b>	<b>209-S4303-02S015</b>	
			<b>209-S3303-02S030</b>	<b>209-S4303-02S030</b>	

The configuration of connectors and the cable length can be customized. For more details, please contact Dinkle  
**Bolded part number is cULus certified.**

## M12 S-Code Device Circular Connector

### Front mounting with 0.5 wire

Male

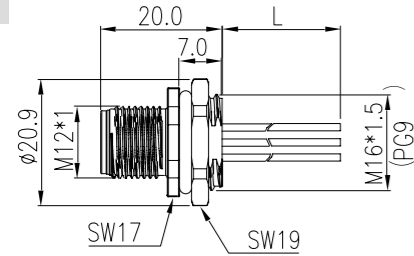

Female

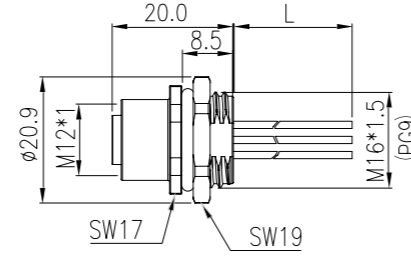

### Front mounting with solder cup pin

Male

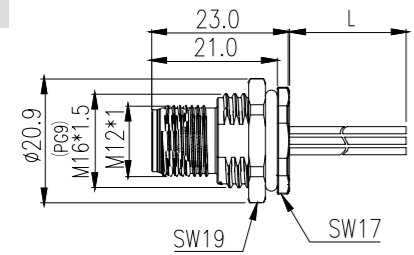

Female

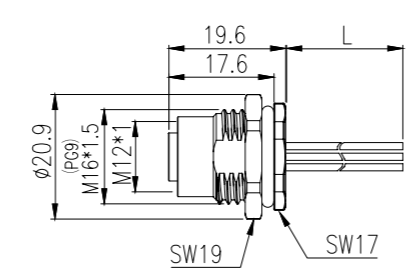

### Rear mounting with 0.5m wire

Male

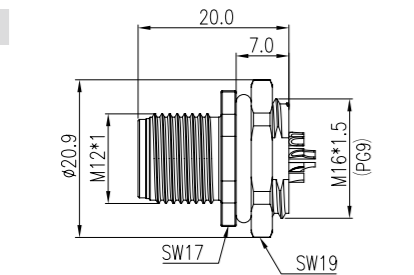

Female

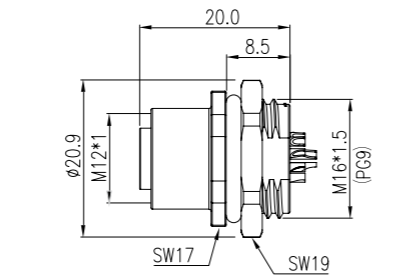

### Rear mounting with solder cup pin

Male

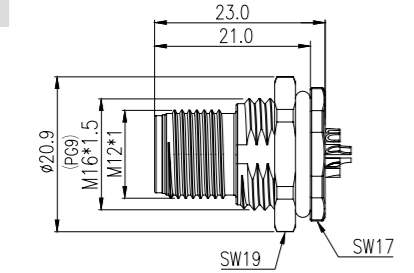

Female

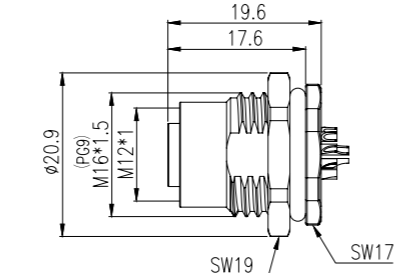

### Pin assignments and wire color

Pin arrangement	3P		4P	
	S code			
Pin out	1	Black	1	Black
	2	-	2	Black
	3	Black	3	Black
	PE	Yellow / Green	PE	Yellow / Green

## M12 S-Code Device Connector

Mechanical Properties		Material Properties	
Min. Insertion/withdrawal cycles	100	Contact / contact surface	Copper alloy / Gold plated
Degree of protection	IP67	Contact carrier	PA
Operating Temperature	-40°C ~ 80°C	Hexagonal nut / Outer Shield	Zinc die-cast, nickel-plated
Fasten torque	0.4 Nm	O-ring	NBR
Mounting torque	0.8 Nm	UL94 Flammability rating	V0

Electrical Properties		Cable Information	
Rated voltage / current (contacts)	630VAC / 16A (3 Pin)	Cable Jacket	MPPE
	630VAC / 12A (4 Pin)	UL AWM style	No Shield MPPE : AWM 11029
Rated Impulse Voltage	6kV (3 Pin)	Conductor cross section	1.5mm <sup>2</sup> /16AWG (3 Pin)
	6kV (4 Pin)		1.5mm <sup>2</sup> /16AWG (4 Pin)
Insulation resistance	Min. 100MΩ	Material conductor insulation	MPPE
Overvoltage Category	III	Flame resistance	VW-1 / FT1
Pollution Degree	3	Dielectric strength	NA

Standards and Regulations	
Design reference	IEC 61076-2-101: Detail specification for M12 connectors with screw-locking IEC 60512: Electromechanical components for electronic equipment; basic testing procedure and measuring methods IEC 60529: Degree of protection provided by enclosures (IP Code)
Certification reference	UL 2238

Notice	
The mechanical and electrical data performance can be ensured when the connector pair is correctly locked and fasten by specified torque. If the connector is not locked and or exposed in th contaminated enviroment, the connector must be sealed by the protective cover. Also, the influences from conductor, cable or PCB assembly must be taken into consideration.	

## M12 S-Code Device Connector ( No Shield )

Coding and contacts	Code	S		S	
	Contact	3 (2+PE)		3 (2+PE)	
Rated voltage / current	630V / 16A				
Contact arrangement	Male	Female		Male	Female
					
Front mounting with 0.5m wire					
Connector style	Mount thread	Part number			
 Male	M16 X 1.5	<b>218-S3300-0MSL50</b>	<b>218-S4300-0MSL50</b>		
	Pg9	<b>218-S3302-0MSL50</b>	<b>218-S4302-0MSL50</b>		
 Female	M16 X 1.5	<b>219-S3300-0MSL50</b>	<b>219-S4300-0MSL50</b>		
	Pg9	<b>219-S3302-0MSL50</b>	<b>219-S4302-0MSL50</b>		
Rear mounting with 0.5m wire					
Connector style	Mount thread	Part number			
 Male	M16 X 1.5	<b>220-S3300-0MSL50</b>	<b>220-S4300-0MSL50</b>		
	Pg9	<b>220-S3302-0MSL50</b>	<b>220-S4302-0MSL50</b>		
 Female	M16 X 1.5	<b>221-S3300-0MSL50</b>	<b>221-S4300-0MSL50</b>		
	Pg9	<b>221-S3302-0MSL50</b>	<b>221-S4302-0MSL50</b>		

The wire length can be customized. For more details, please contact Dinkle  
**Bolded part number is cULus certified.**

## M12 T-Code Molded Circular Connector

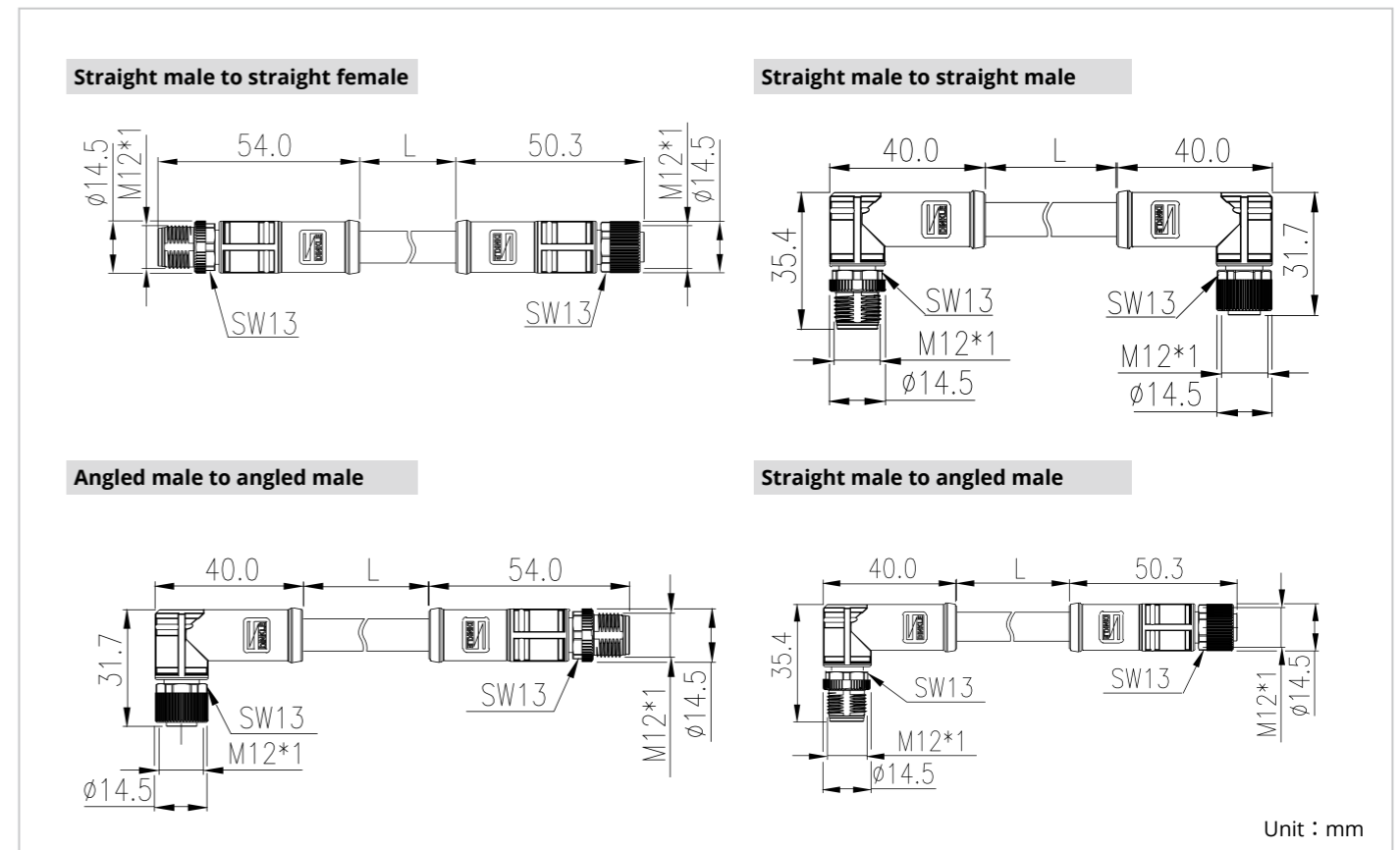
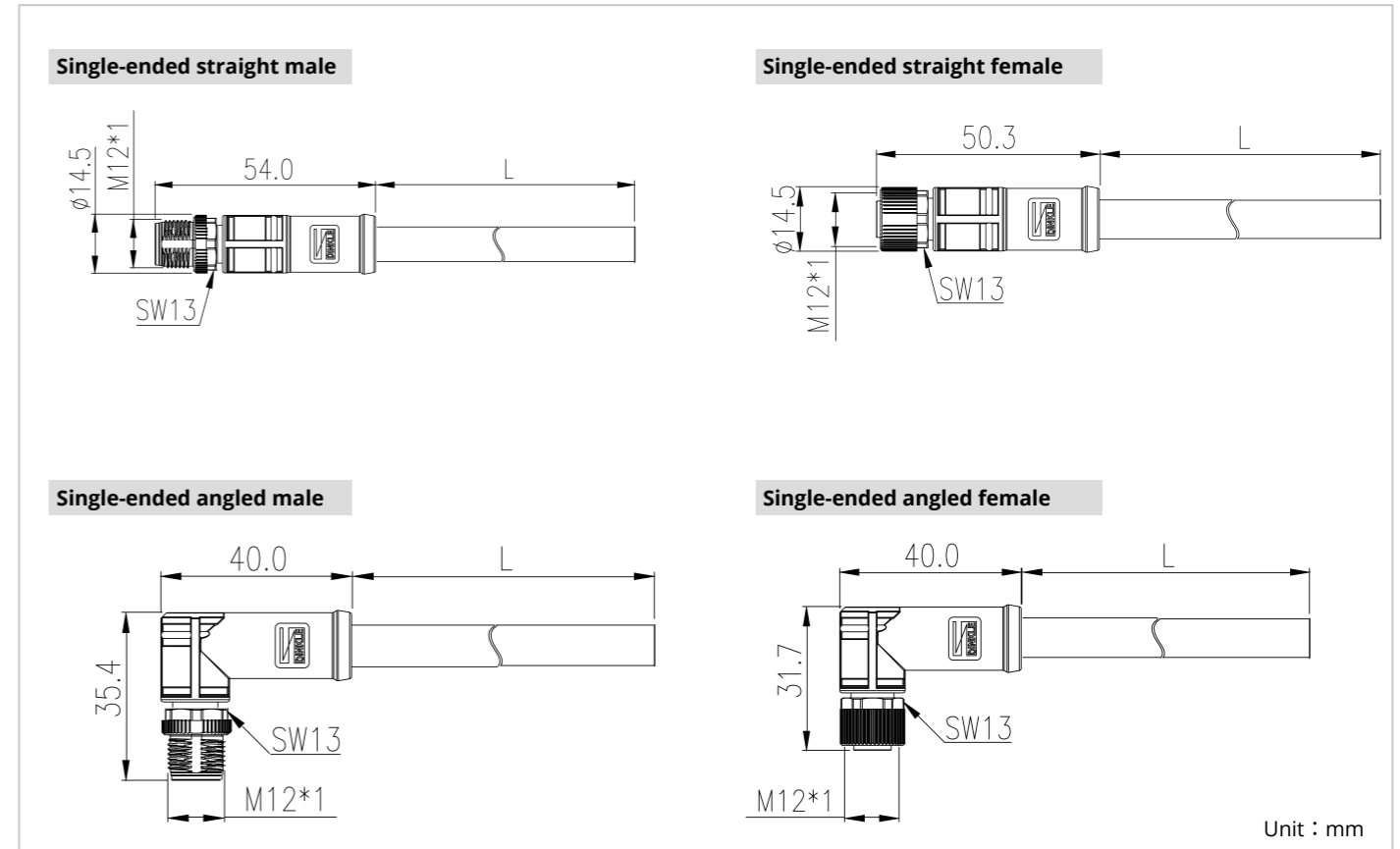

## M12 T-Code Molded Connector

Mechanical Properties		Material Properties	
Min. Insertion/withdrawal cycles	100	Contact / contact surface	Copper alloy / Gold plated
Degree of protection	IP67	Contact carrier / overmolding	PUR / PP
Operating Temperature	-40°C ~ 80°C ( Fixed installation )	O-ring	NBR
	-25°C ~ 80°C ( Flexible installation )	Cable gland material	Zinc die-cast, nickel-plated
鎖緊扭矩	0.4 Nm	UL94 Flammability rating	V0
Electrical Properties		Cable Information	
Rated voltage / current (contacts)	63VAC / 12A (4 Pin)	Cable Jacket	PUR, BLACK
Rated Impulse Voltage	1.5kV (4 Pin)	UL AWM style	No Shield   PUR : UL AWM 20936
Insulation resistance	Min. 100MΩ	Conductor cross section	1.5mm <sup>2</sup> /16AWG (4 Pin)
Overvoltage Category	III	Material conductor insulation	PP
Pollution Degree	3	Flame resistance	VW-1/FT1
		Dielectric strength	2.0KV/1min
Standards and Regulations			
Design reference	IEC 61076-2-111: Circular connectors - Detail specification for power connectors with M12 screw-locking IEC 60512: Electromechanical components for electronic equipment; basic testing procedure and measuring methods IEC 60529: Degree of protection provided by enclosures (IP Code)		
Certification reference	UL 2237		
Notice			
The mechanical and electrical data performance can be ensured when the connector pair is correctly locked and fasten by specified torque. If the connector is not locked and or exposed in th contaminated enviroment, the connector must be sealed by the protective cover. Also, the influences from conductor, cable or PCB assembly must be taken into consideration.			

## M12 T-Code Molded Connector ( No Shield )

Coding and contacts		Code	T	
		Contact	4	
Rated voltage / current		63V / 12A		
Contact arrangement		Male	Female	
				
Connector style	Cable	Length(m)	Part number	
 Single-ended straight male	PUR	2	<b>201-T4303-02S020</b>	
		5	<b>201-T4303-02S050</b>	
		10	<b>201-T4303-02S100</b>	
 Single-ended straight female	PUR	2	<b>202-T4303-02S020</b>	
		5	<b>202-T4303-02S050</b>	
		10	<b>202-T4303-02S100</b>	
 Single-ended angled male	PUR	2	<b>203-T4303-02S020</b>	
		5	<b>203-T4303-02S050</b>	
		10	<b>203-T4303-02S100</b>	
 Single-ended angled female	PUR	2	<b>204-T4303-02S020</b>	
		5	<b>204-T4303-02S050</b>	
		10	<b>204-T4303-02S100</b>	
 Straight male mate straight female	PUR	0.6	<b>206-T4303-02SL60</b>	
		1.5	<b>206-T4303-02S015</b>	
		3	<b>206-T4303-02S030</b>	
 Angled male mate angled female	PUR	0.6	<b>209-T4303-02SL60</b>	
		1.5	<b>209-T4303-02S015</b>	
			<b>209-T4303-02S030</b>	

The configuration of connectors and the cable length can be customized. For more details, please contact Dinkle  
**Bolded part number is cULus certified.**

## M12 T-Code Device Circular Connector

### Front mounting with 0.5m wire

Male

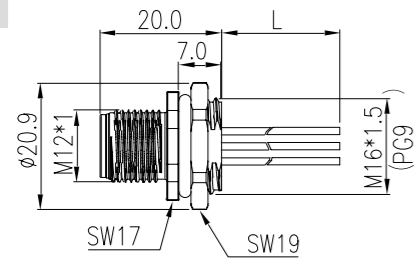

Female

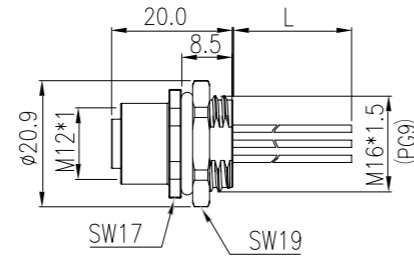

### Front mounting with solder cup pin

Male

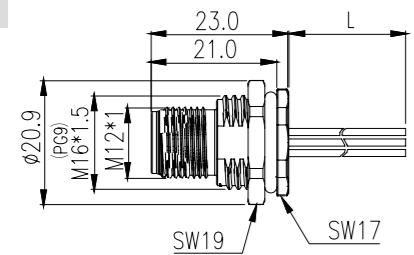

Female

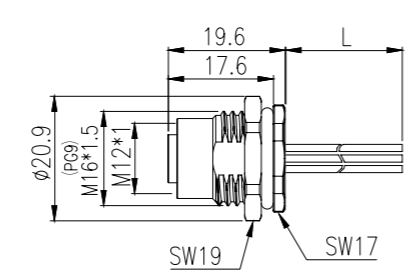

### Rear mounting with 0.5m wire

Male

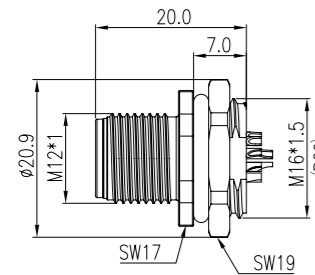

Female

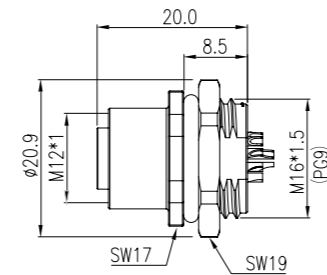

### Rear mounting with solder cup pin

Male

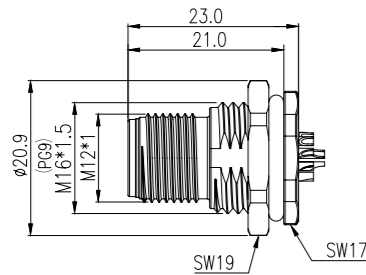

Female

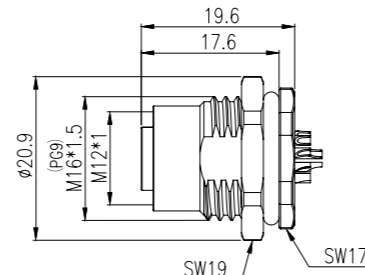

### Pin assignments and wire colors

Pin arrangement		
	4P	
Pin out	1	Brown
	2	White
	3	Blue
	4	Black

## M12 T-Code Device Connector

Mechanical Properties		Material Properties	
Min. Insertion/withdrawal cycles	100	Contact / contact surface	Copper alloy / Gold plated
Degree of protection	IP67	Contact carrier	PA
Operating Temperature	-40°C ~ 80°C	Hexagonal nut / Outer Shield	Zinc die-cast, nickel-plated
Fasten torque	0.4 Nm	O-ring	NBR
Mounting torque	0.8 Nm	UL94 Flammability rating	V0
Electrical Properties		Cable Information	
Rated voltage / current (contacts)	63VAC / 12A (4 Pin)	Cable Jacket	MPPE
Rated Impulse Voltage	1.5kV (4 Pin)	UL AWM style	MPPE : AWM 11027
Insulation resistance	Min. 100MΩ	Conductor cross section	1.5mm <sup>2</sup> / 16AWG (4 Pin)
Overvoltage Category	III	Material conductor insulation	MPPE
Pollution Degree	3	Flame resistance	VW-1 / FT1
		Dielectric strength	NA
Standards and Regulations			
Design reference	IEC 61076-2-101: Detail specification for M12 connectors with screw-locking		
	IEC 60512: Electromechanical components for electronic equipment; basic testing procedure and measuring methods		
	IEC 60529: Degree of protection provided by enclosures (IP Code)		
Certification reference	UL 2238		
Notice			
The mechanical and electrical data performance can be ensured when the connector pair is correctly locked and fasten by specified torque. If the connector is not locked and or exposed in th contaminated enviroment, the connector must be sealed by the protective cover. Also, the influences from conductor, cable or PCB assembly must be taken into consideration.			

## M12 T-Code Device Connector ( No Shield )

Coding and contacts	Code Contact	T 4	
Rated voltage / current	63V / 12A		
Contact arrangement	Male 	Female 	
Front mounting with 0.5m wire			
Connector style	Mount thread	Part number	
	M16 X 1.5	<b>218-T4300-0MSL50</b>	
	Pg9	<b>218-T4302-0MSL50</b>	
	M16 X 1.5	<b>219-T4300-0MSL50</b>	
	Pg9	<b>219-T4302-0MSL50</b>	
Rear mounting with 0.5m wire			
Connector style	Mount thread	Part number	
	M16 X 1.5	<b>220-T4300-0MSL50</b>	
	Pg9	<b>220-T4302-0MSL50</b>	
	M16 X 1.5	<b>221-T4300-0MSL50</b>	
	Pg9	<b>221-T4302-0MSL50</b>	

The wire length can be customized. For more details, please contact Dinkle  
**Bolded part number is cULus certified.**

## M12 T-Code One-piece PCB Circular Connector

### 180° Rear mounting, straight (Shielded)

#### Male

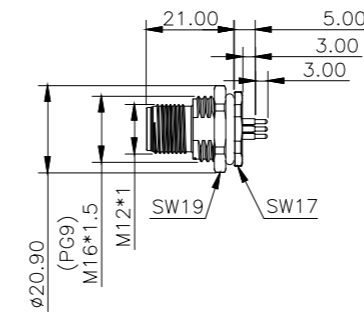

#### Female

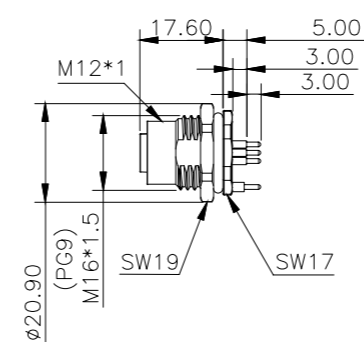

#### PCB Layout

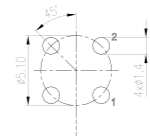
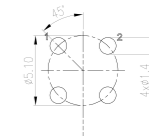
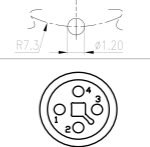
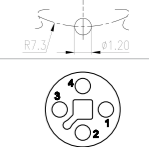
Pin out		
Pin arrangement		
4P T-code		

#### PCB Layout

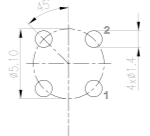
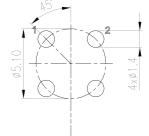
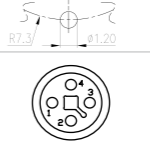
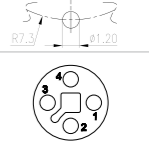
Pin out		
Pin arrangement		
4P T-code		

### 180° Rear mounting, straight (NonShielded)

#### Male

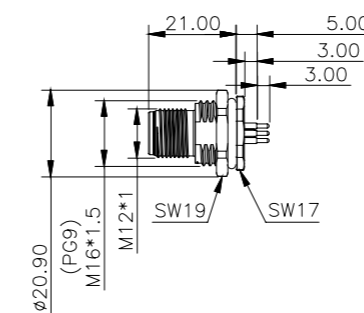

#### Female

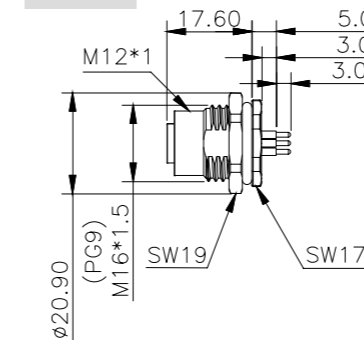

#### PCB Layout

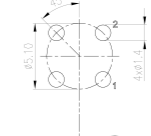
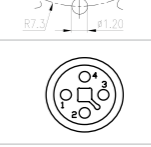
Pin out	
Pin arrangement	
4P T-code	



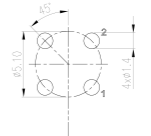
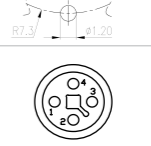



#### PCB Layout

Pin out	
Pin arrangement	
4P T-code	

## M12 T-Code One-piece PCB Connector

Mechanical Properties		Material Properties	
Min. Insertion/withdrawal cycles	100	Contact / contact surface	Copper alloy / Gold plated
Degree of protection	IP67	Contact carrier	PA
Operating Temperature	-40°C ~ 80°C	Hexigonal nut / Outer Shield	Zinc die-cast, nickel-plated / Brass, nickel-plated
Fasten torque	0.4 Nm	O-ring	NBR
Soldering method	Wave Soldering	UL94 Flammability rating	V0
Electrical Properties		Cable Information	
Rated voltage / current (contacts)	63VAC / 12A (4 Pin)		
Rated Impulse Voltage	1.5kV (4 Pin)		
Insulation resistance	Min. 100MΩ		
Overvoltage Category	III		
Pollution Degree	3		
Standards and Regulations			
Design reference	IEC 61076-2-101: Detail specification for M12 connectors with screw-locking IEC 61076-2-111: Circular connectors - Detail specification for power connectors with M12 screw-locking IEC 60512: Electromechanical components for electronic equipment; basic testing procedure and measuring methods IEC 60529: Degree of protection provided by enclosures (IP Code)		
Certification reference	UL 2238		
Notice			
The mechanical and electrical data performance can be ensured when the connector pair is correctly locked and fasten by specified torque. If the connector is not locked and or exposed in th contaminated enviroment, the connector must be sealed by the protective cover. Also, the influences from conductor, cable or PCB assembly must be taken into consideration.			

## M12 T-Code One-piece PCB Connector ( Shield / No Shield )

Coding and contacts	Code	T	
	Contact	4	
Rated voltage / current		63V / 12A	
Contact arrangement		Male 	Female 
Rear mounting, straight, Shield			
Connector style	Mount thread	Part number	
 Male	M16 X 1.5	<b>276-T4300-6</b>	
	Pg9	<b>276-T4302-6</b>	
 Female	M16 X 1.5	<b>277-T4300-6</b>	
	Pg9	<b>277-T4302-6</b>	
Rear mounting, straight, No Shield			
Connector style	Mount thread	Part number	
 Male	M16 X 1.5	<b>226-T4300-6</b>	
	Pg9	<b>226-T4302-6</b>	
 Female	M16 X 1.5	<b>227-T4300-6</b>	
	Pg9	<b>227-T4302-6</b>	

Bolded part number is cULus certified.

## M12 X-Code Two-piece PCB Circular Connector

### 180° Rear mounting, straight (Shielded)

Female

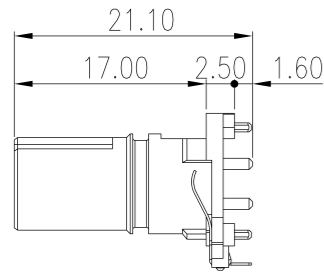

PCB Layout	
Pin out	
Pin arrangement	
	8P X-code

## M12 X-Code Two-piece PCB Connector

Mechanical Properties		Material Properties	
Min. Insertion/withdrawal cycles	100	Contact / contact surface	Copper alloy / Gold plated
Degree of protection	IP67	Contact carrier	LCP
Operating Temperature	-40°C ~ 125°C	O-ring	NBR
Soldering method	THR	Moisture Sensitivity Levels	1
		UL94 Flammability rating	V0
Electrical Properties		Cable Information	
Rated voltage / current (contacts)	50VAC / 0.5A (8 Pin)		
Rated Impulse Voltage	0.8kV (8 Pin)		
Insulation resistance	Min. 100MΩ		
Overtoltage Category	II		
Pollution Degree	3		
Standards and Regulations			
Design reference	IEC 61076-2-101: Detail specification for M12 connectors with screw-locking IEC 60512: Electromechanical components for electronic equipment; basic testing procedure and measuring methods IEC 60529: Degree of protection provided by enclosures (IP Code)		
Notice			
The mechanical and electrical data performance can be ensured when the connector pair is correctly locked and fasten by specified torque. If the connector is not locked and or exposed in th contaminated enviroment, the connector must be sealed by the protective cover. Also, the influences from conductor, cable or PCB assembly must be taken into consideration.			

## M12 X-Code Two-piece PCB Connector ( Shield / No Shield )

Coding and contacts	Code	X
	Contact	8
Rated voltage / current		60V/0.5A
Contact arrangement		Female 
THR Soldering, straight, shield		
Connector style	package	Part number
Male 	Tray	-
	Tape-and reel	-
Female 	Tray	<b>282-X8100S-1</b>
	Tape-and reel	<b>282-X8100S-2</b>
THR Soldering, straight, No shield		
Connector style	package	Part number
Male 	Tray	-
	Tape-and reel	-
Female 	Tray	-
	Tape-and reel	-
Metal housing		
Connector style	Mount thread	Part number
Male use 	M15 x 1	-
Female use 	M15 x 1	284-T2220

**Bolded part number is cULus certified.**

Package unit, Tray : 60 pcs; Tape-and-Reel : 100 pcs

## M12 L-Code Molded Circular Connector

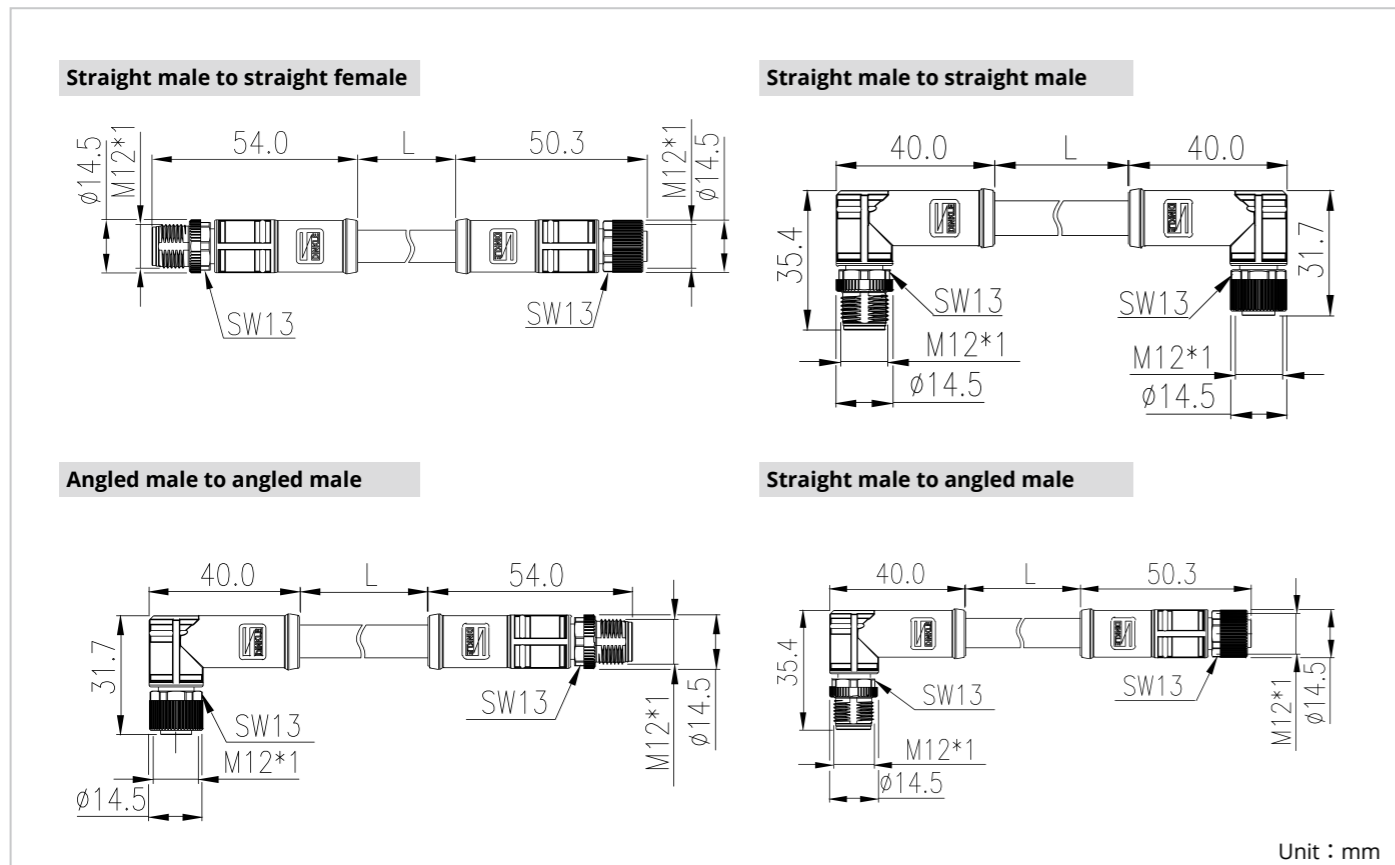
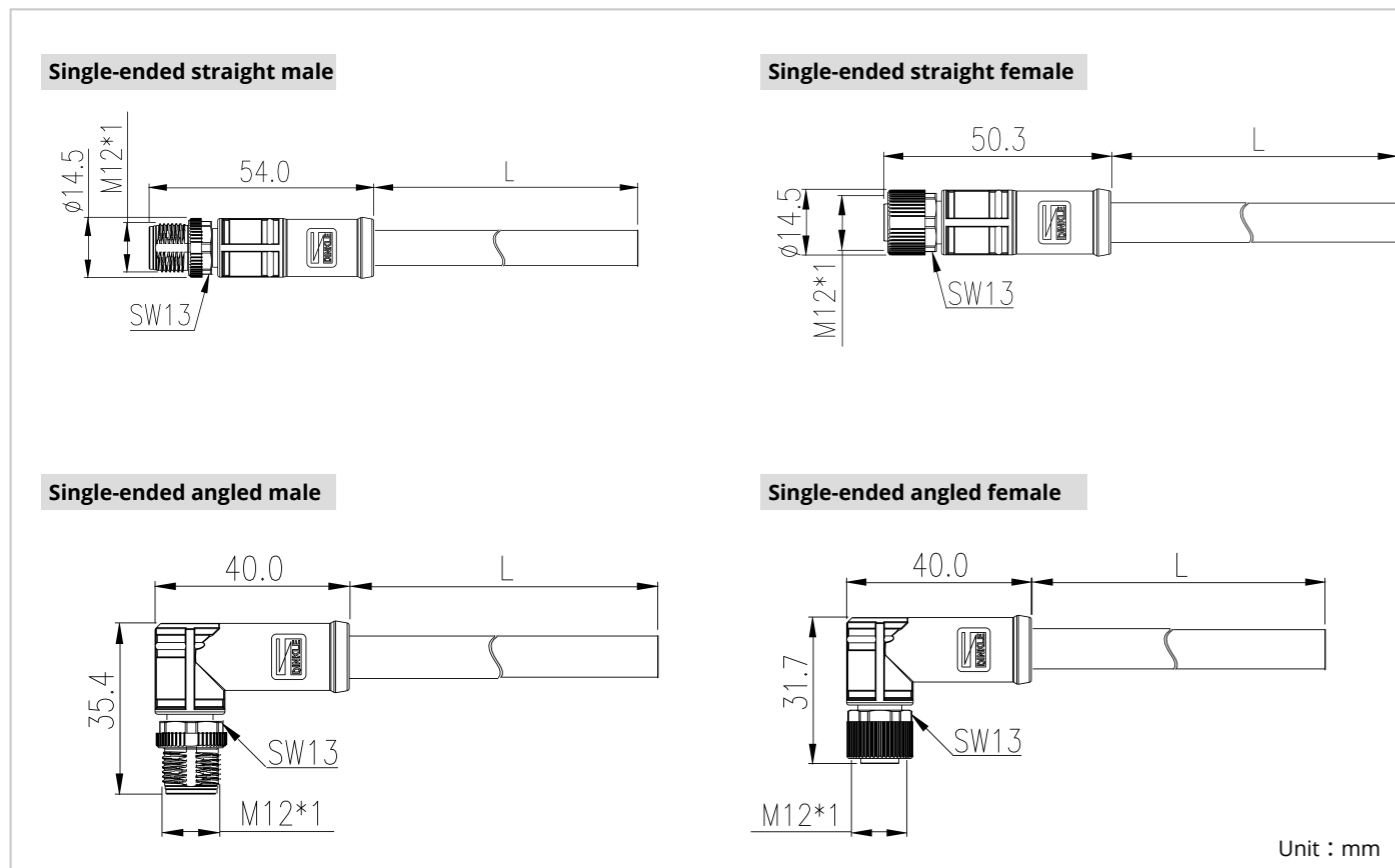

## M12 L-Code Molded Connector

Mechanical Properties		Material Properties	
Min. Insertion/withdrawal cycles	100	Contact / contact surface	Copper alloy / Gold plated
Degree of protection	IP67	Contact carrier / overmolding	PA / PP
Operating Temperature	-40°C ~ 80°C ( Fixed installation )	O-ring	NBR
	-25°C ~ 80°C ( Flexible installation )	Cable gland material	Zinc die-cast, nickel-plated
Fasten torque	0.4 Nm	UL94 Flammability rating	V0
Electrical Properties		Cable Information	
Rated voltage / current (contacts)	63VAC / 16A (4 Pin)	Cable Jacket	PUR, GREY
	63VAC / 16A (5 Pin)		UL AWM 20233 (4 Pin)
Rated Impulse Voltage	1.5kV (4 Pin)	UL AWM style	UL AWM 20233 (5 Pin)
	1.5kV (5 Pin)		Conductor cross section
Insulation resistance	Min. 100MΩ		2.5mm <sup>2</sup> / 14AWG (5 Pin)
Overvoltage Category	III	Material conductor insulation	PE
Pollution Degree	3	Flame resistance	FT2
		Dielectric strength	2.0KV/1min
Standards and Regulations			
Design reference	IEC 61076-2-111: Circular connectors - Detail specification for power connectors with M12 screw-locking IEC 60512: Electromechanical components for electronic equipment; basic testing procedure and measuring methods IEC 60529: Degree of protection provided by enclosures (IP Code)		
Certification reference	UL 2238		
Notice			
The mechanical and electrical data performance can be ensured when the connector pair is correctly locked and fasten by specified torque. If the connector is not locked and or exposed in th contaminated enviroment, the connector must be sealed by the protective cover. Also, the influences from conductor, cable or PCB assembly must be taken into consideration.			

## M12 L-Code Molded Connector ( No Shield )

Coding and contacts		Code	L		L	
		Contact	4		5(4+FE)	
Rated voltage / current		63V / 16A		63V / 16A		
Contact arrangement		Male	Female	Male	Female	
Connector style		Cable	Length(m)	Part number		
 Single-ended straight male	PUR	2	201-L4103-02S020	201-L5103-02S020		
		5	201-L4103-02S050	201-L5103-02S050		
		10	201-L4103-02S100	201-L5103-02S100		
 Single-ended straight female	PUR	2	202-L4103-02S020	202-L5103-02S020		
		5	202-L4103-02S050	202-L5103-02S050		
		10	202-L4103-02S100	202-L5103-02S100		
 Single-ended angled male	PUR	2	203-L4103-02S020	203-L5103-02S020		
		5	203-L4103-02S050	203-L5103-02S050		
		10	203-L4103-02S100	203-L5103-02S100		
 Single-ended angled female	PUR	2	204-L4103-02S020	204-L5103-02S020		
		5	204-L4103-02S050	204-L5103-02S050		
		10	204-L4103-02S100	204-L5103-02S100		
 Straight male mate straight female	PUR	0.6	206-L4103-02SL60	206-L5103-02SL60		
		1.5	206-L4103-02S015	206-L5103-02S015		
		3	206-L4103-02S030	206-L5103-02S030		
 Angled male mate angled female"	PUR	0.6	209-L4103-02SL60	209-L5103-02SL60		
		1.5	209-L4103-02S015	209-L5103-02S015		
		3	209-L4103-02S030	209-L5103-02S030		

The configuration of connectors and the cable length can be customized. For more details, please contact Dinkle

## M12 L-Code Device Circular Connector

### Front mounting with 0.5m wire

Male

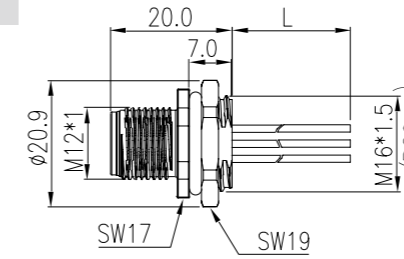

Female

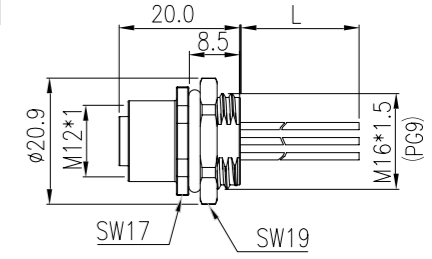

### Front mounting with solder cup pin

Male

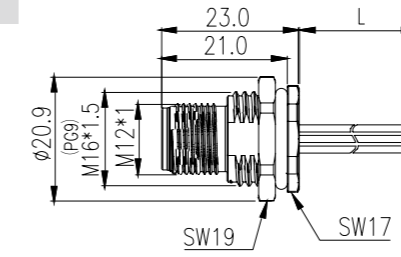

Female

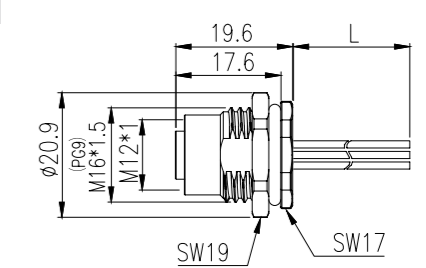

### Rear mounting with 0.5m wire

Male

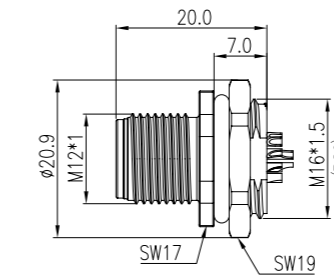

Female

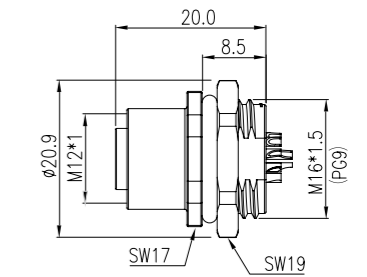

### Rear mounting with solder cup pin

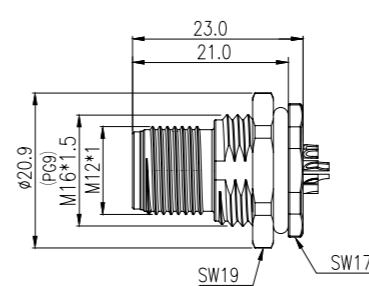

Male

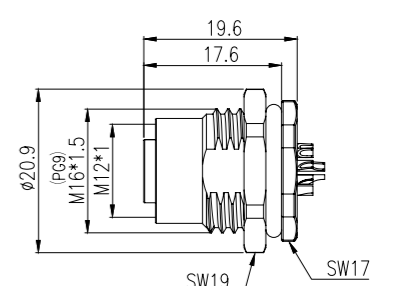

Female









### Pin assignments and wire colors

Pin arrangement	 4P		 5P	
	L code			
Pin out	1	Brown	1	Brown
	2	White	2	White
	3	Blue	3	Blue
	4	Black	4	Black
			FE	Pink

## M12 L-Code Device Connector

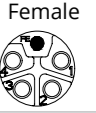
Mechanical Properties		Material Properties	
Min. Insertion/withdrawal cycles	100	Contact / contact surface	Copper alloy / Gold plated
Degree of protection	IP67	Contact carrier	PA
Operating Temperature	-40°C ~ 80°C	Hexagonal nut / Outer Shield	Zinc die-cast, nickel-plated
Fasten torque	0.4 Nm	O-ring	NBR
Mounting torque	0.8 Nm	UL94 Flammability rating	V0
Electrical Properties		Cable Information	
Rated voltage / current (contacts)	63VAC / 16A (4 Pin)	Cable Jacket	MPPE
	63VAC / 16A (5 Pin)	Cable Jacket	MPPE : AWM 11027
Rated Impulse Voltage	1.5kV (4 Pin)	Conductor cross section	2.5mm <sup>2</sup> / 14AWG (4 Pin)
	1.5kV (5 Pin)		2.5mm <sup>2</sup> / 14AWG (5 Pin)
Insulation resistance	Min. 100MΩ	Material conductor insulation	MPPE
Overvoltage Category	III	Flame resistance	VW-1
Pollution Degree	3	Dielectric strength	2.0kV/1min
Standards and Regulations			
Design reference	IEC 61076-2-111: Circular connectors - Detail specification for power connectors with M12 screw-locking		
	IEC 60512: Electromechanical components for electronic equipment; basic testing procedure and measuring methods		
	IEC 60529: Degree of protection provided by enclosures (IP Code)		
Certification reference	UL 2238		
Notice			
The mechanical and electrical data performance can be ensured when the connector pair is correctly locked and fasten by specified torque. If the connector is not locked and or exposed in th contaminated enviroment, the connector must be sealed by the protective cover. Also, the influences from conductor, cable or PCB assembly must be taken into consideration.			

## M12 L-Code Device Connector ( No Shield )

Coding and contacts	Code	L		L	
	Contact	4		5(4+FE)	
Rated voltage / current		63V / 16A		63V / 16A	
Contact arrangement		Male 	Female 	Male 	Female 
Front mounting with 0.5m wire					
Connector style	Mount thread	Part number			
Male 	M16 X 1.5	218-L4100-0MSL50	218-L5100-0MSL50		
	Pg9	218-L4102-0MSL50	218-L5102-0MSL50		
Female 	M16 X 1.5	219-L4100-0MSL50	219-L5100-0MSL50		
	Pg9	219-L4102-0MSL50	219-L5102-0MSL50		
Rear mounting with 0.5m wire					
Connector style	Mount thread	Part number			
Male 	M16 X 1.5	220-L4100-0MSL50	220-L5100-0MSL50		
	Pg9	220-L4102-0MSL50	220-L5102-0MSL50		
Female 	M16 X 1.5	221-L4100-0MSL50	221-L5100-0MSL50		
	Pg9	221-L4102-0MSL50	221-L5102-0MSL50		

The wire length can be customized. For more details, please contact Dinkle

## M12 L-Code One-piece PCB Circular Connector

### 180° Rear mounting, straight (Shielded)

Male

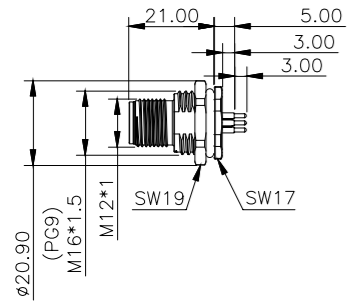

Female

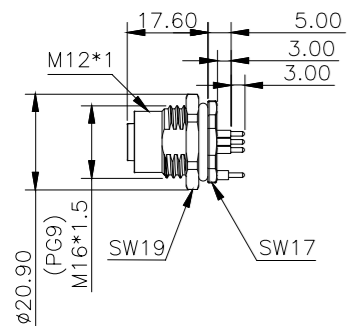

PCB Layout	
Pin out	
Pin arrangement	
4P L-code	

PCB Layout	
Pin out	
Pin arrangement	
4P L-code	

### 180° Rear mounting, straight (NonShielded)

Male

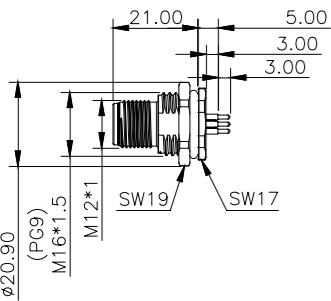

Female

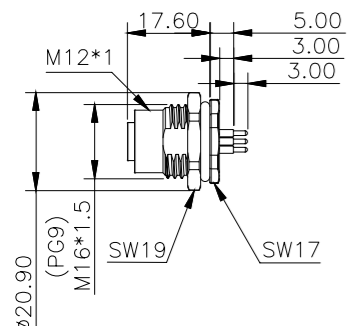

PCB Layout	
Pin out	
Pin arrangement	
4P L-code	

PCB Layout	
Pin out	
Pin arrangement	
4P L-code	

## M12 L-Code One-piece PCB Connector

Mechanical Properties		Material Properties	
Min. Insertion/withdrawal cycles	100	Contact / contact surface	Copper alloy / Gold plated
Degree of protection	IP67	Contact carrier	PA
Operating Temperature	-40°C ~ 80°C	Hexigonal nut / Outer Shield	Zinc die-cast, nickel-plated / Brass, nickel-plated
Fasten torque	0.4 Nm	O-ring	NBR
Soldering method	Wave Soldering	UL94 Flammability rating	V0

Electrical Properties		Cable Information	
Rated voltage / current (contacts)	63VAC / 12A (4 Pin)		
	63VAC / 12A (5 Pin)		
Rated Impulse Voltage	1.5kV (4 Pin)		
	1.5kV (5 Pin)		
Insulation resistance	Min. 100MΩ		
Overvoltage Category	III		
Pollution Degree	3		

Standards and Regulations	
Design reference	IEC 61076-2-111: Circular connectors - Detail specification for power connectors with M12 screw-locking IEC 60512: Electromechanical components for electronic equipment; basic testing procedure and measuring methods IEC 60529: Degree of protection provided by enclosures (IP Code)
Certification reference	UL 2238

**Notice**  
The mechanical and electrical data performance can be ensured when the connector pair is correctly locked and fasten by specified torque. If the connector is not locked and or exposed in th contaminated enviroment, the connector must be sealed by the protective cover. Also, the influences from conductor, cable or PCB assembly must be taken into consideration.

## M12 L-Code One-piece PCB Connector ( Shield / No Shield )

Coding and contacts	Code	L		L	
	Contact	4		5	
Rated voltage / current		63V / 16A		63V / 16A	
Contact arrangement	Male		Female	Male	Female
					
<b>Rear mounting, straight, Shield</b>					
Connector style	Mount thread	Part number			
	M16 X 1.5	276-L4100-6		276-L5100-6	
	Pg9	276-L4102-6		276-L5102-6	
	M16 X 1.5	277-L4100-6		277-L5100-6	
	Pg9	277-L4102-6		277-L5102-6	
<b>Rear mounting, straight, No Shield</b>					
Connector style	Mount thread	Part number			
	M16 X 1.5	226-L4100-6		226-L5100-6	
	Pg9	226-L4102-6		226-L5102-6	
	M16 X 1.5	227-L4100-6		227-L5100-6	
	Pg9	227-L4102-6		227-L5102-6	

## M12 L-Code Two-piece PCB Circular Connector

### 180° Rear mounting, straight (Shielded)

Male

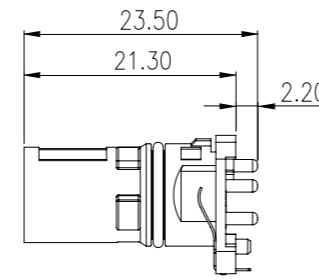

#### PCB Layout

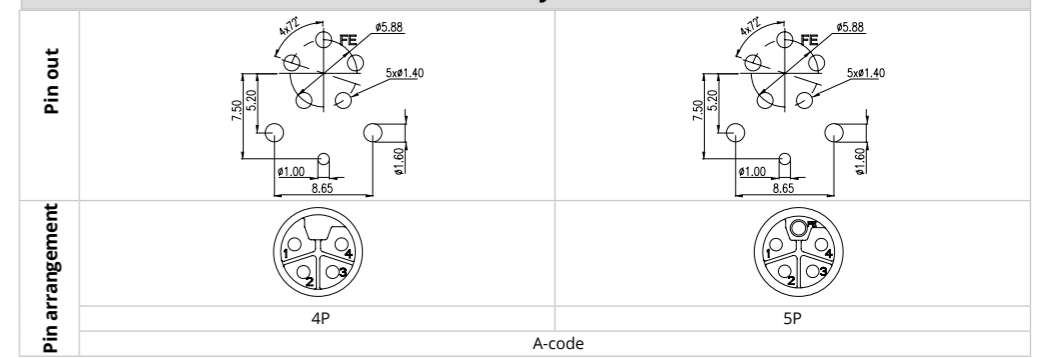

Female

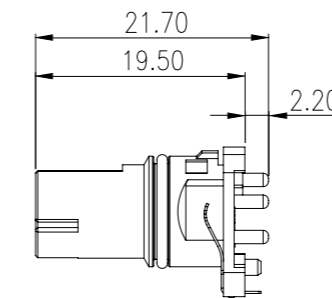

#### PCB Layout

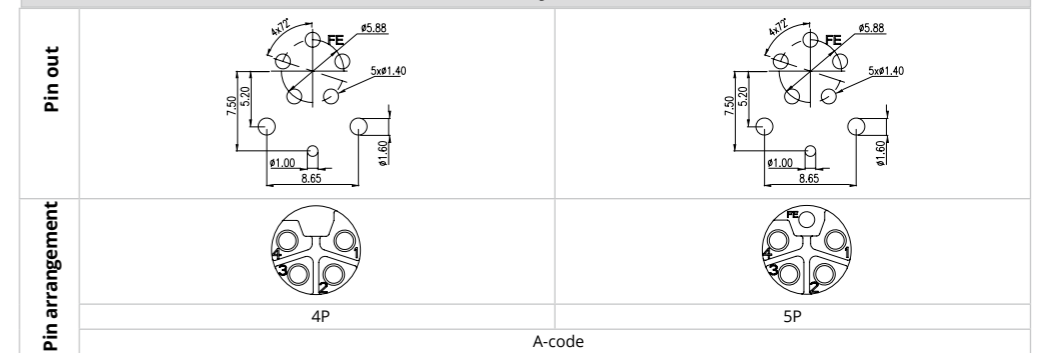

### 180° Rear mounting, straight (NonShielded)

Male

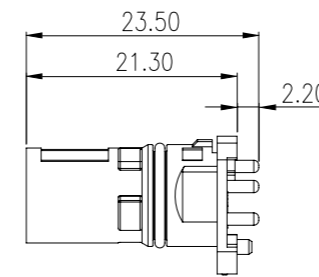

#### PCB Layout

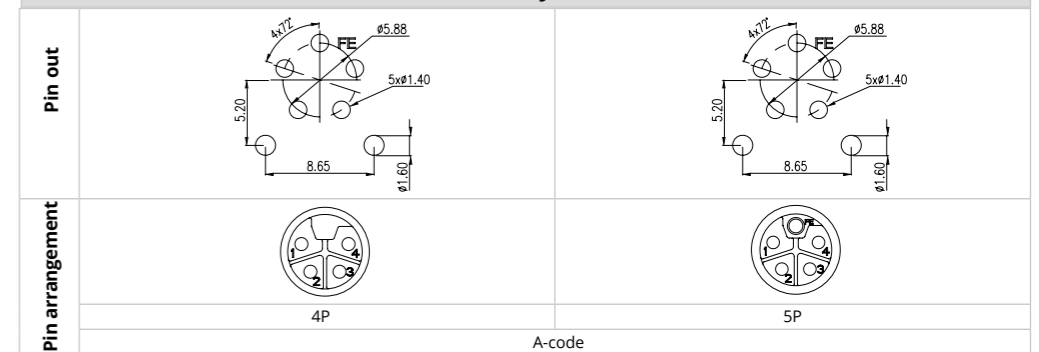

Female

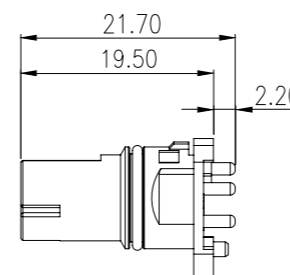

#### PCB Layout

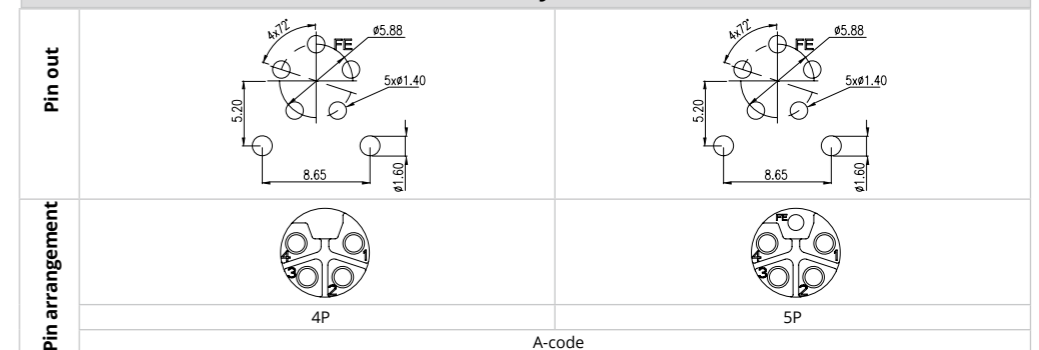

## M12 L-Code Two-piece PCB Connector

Mechanical Properties		Material Properties	
Min. Insertion/withdrawal cycles	100	Contact / contact surface	Copper alloy / Gold plated
Degree of protection	IP67	Contact carrier	LCP
Operating Temperature	-40°C ~ 125°C	O-ring	SILICONE
Soldering method	THR	Moisture Sensitivity Levels	1
		UL94 Flammability rating	V0
Electrical Properties		Cable Information	
Rated voltage / current (contacts)	63VAC / 16A (4 Pin)		
	63VAC / 16A (5 Pin)		
Rated Impulse Voltage	1.5kV (4 Pin)		
	1.5kV (5 Pin)		
Insulation resistance	Min. 100MΩ		
Overvoltage Category	III		
Pollution Degree	3		
Standards and Regulations			
Design reference	IEC 61076-2-101: Detail specification for M12 connectors with screw-locking		
	IEC 60512: Electromechanical components for electronic equipment; basic testing procedure and measuring methods		
	IEC 60529: Degree of protection provided by enclosures (IP Code)		
Notice			
The mechanical and electrical data performance can be ensured when the connector pair is correctly locked and fasten by specified torque. If the connector is not locked and or exposed in th contaminated enviroment, the connector must be sealed by the protective cover. Also, the influences from conductor, cable or PCB assembly must be taken into consideration.			

## M12 L-Code Two-piece PCB Connector ( Shield / No Shield )

Coding and contacts	Code Contact	L 4		L 5	
		Male	Female	Male	Female
Rated voltage / current		250V / 4A		250V / 4A	
Contact arrangement					
THR Soldering, straight, shield					
Connector style	package	Part number			
	Tray	281-L4T01S-1		281-L5T01S-1	
	Tape-and ree	281-L4T01S-2		281-L5T01S-2	
	Tray	282-L4T01S-1		282-L5T01S-1	
	Tape-and ree	282-L4T01S-2		282-L5T01S-2	
THR Soldering, straight, No shield					
Connector style	package	Part number			
	Tray	281-L4T01U-1		281-L5T01U-1	
	Tape-and ree	281-L4T01U-2		281-L5T01U-2	
	Tray	282-L4T01U-1		282-L5T01U-1	
	Tape-and ree	282-L4T01U-2		282-L5T01U-2	
Metal housing					
Connector style	Mount thread	Part number			
	M15 x 1	283-P1100			
	M15 x 1	284-P1100			

Package unit, Tray : 60 pcs; Tape-and-Reel : 100 pcs

## M12 K-Code Molded Circular Connector

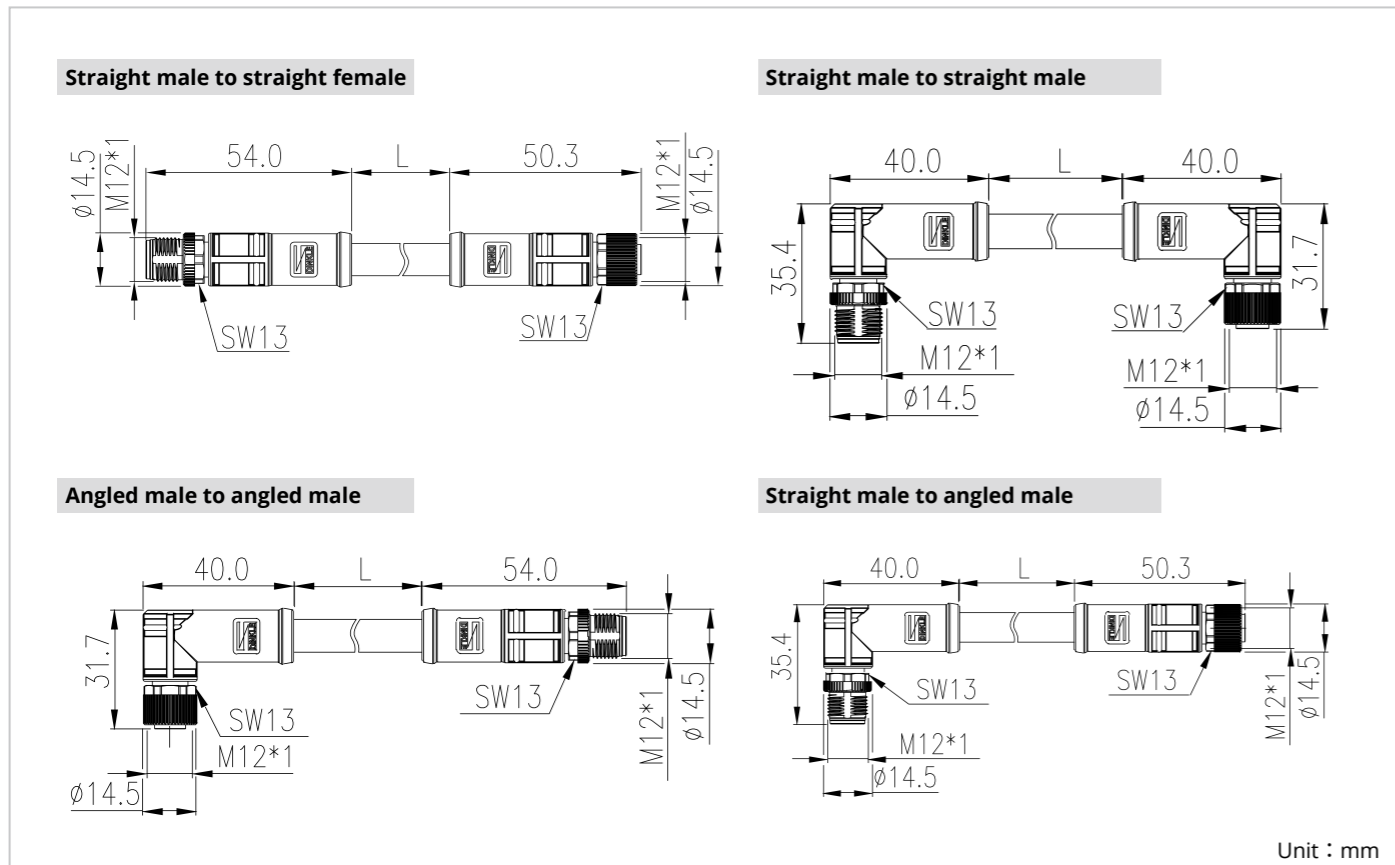
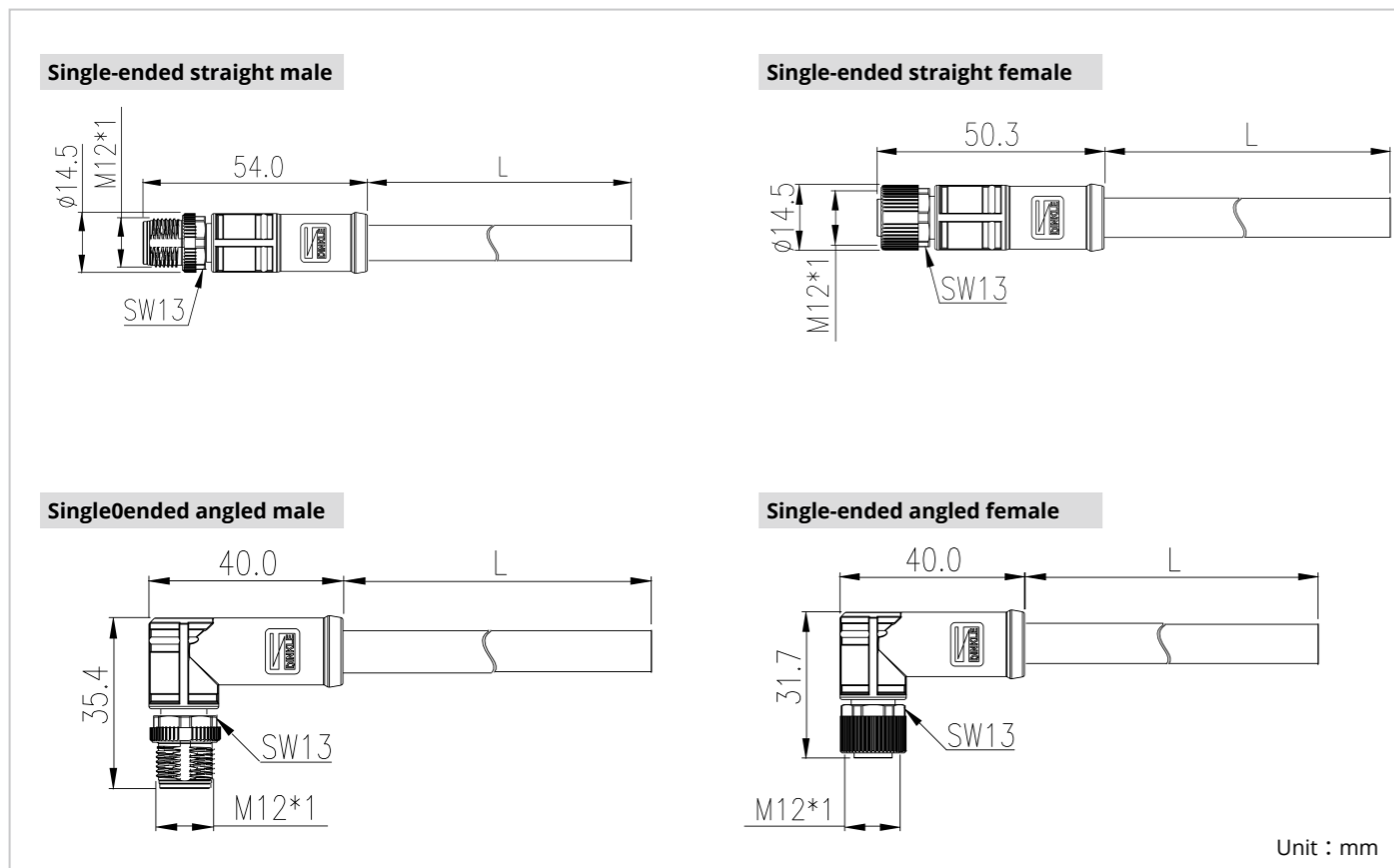









## M12 K-Code Molded Connector

Mechanical Properties		Material Properties		
Min. Insertion/withdrawal cycles	100	Contact / contact surface	Copper alloy / Gold plated	
Degree of protection	IP67	Contact carrier / overmolding	PA / PP	
Operating Temperature	-40°C ~ 80°C ( Fixed installation )	O-ring	NBR	
	-25°C ~ 80°C ( Flexible installation )	Cable gland material	Zinc die-cast, nickel-plated	
Fasten torque	0.4Nm	UL94 Flammability rating	V0	
Electrical Properties		Cable Information		
Rated voltage / current (contacts)	630VAC / 16A (5 Pin)	Cable Jacket	No Shield	PUR, BLACK
Rated Impulse Voltage	4kV (5 Pin)		Shield	PUR, ORANGE
Insulation resistance	Min. 100MΩ	UL AWM style	No Shield	UL AWM 21223
Overvoltage Category	II		Shield	UL AWM 21223
Pollution Degree	3	PUR , ORANGE	1.5mm <sup>2</sup> / 14AWG (5 Pin)	
		Material conductor insulation	PP	
		Flame resistance	VW-1 / FT1	
		Dielectric strength	3kV/1min	
Standards and Regulations				
Design reference	IEC 61076-2-111: Circular connectors - Detail specification for power connectors with M12 screw-locking IEC 60512: Electromechanical components for electronic equipment; basic testing procedure and measuring methods IEC 60529: Degree of protection provided by enclosures (IP Code)			
Certification reference	UL 2237			

### Notice

The mechanical and electrical data performance can be ensured when the connector pair is correctly locked and fasten by specified torque. If the connector is not locked and or exposed in th contaminated enviroment, the connector must be sealed by the protective cover. Also, the influences from conductor, cable or PCB assembly must be taken into consideration.

## M12 K-Code Molded Connector ( Shield / No Shield )

Coding and contacts		Code	K	
Rated voltage / current		Contact	5(4+PE)	
Rated voltage / current			630V / 16A	
Rated voltage / current			Male	Female
				
Shield				
Connector style	Cable	Length(m)	Part number	
 Single-ended straight male	PUR	2	251-K5103-02S020	
		5	251-K5103-02S050	
		10	251-K5103-02S100	
 Single-ended straight female	PUR	2	252-K5103-02S020	
		5	252-K5103-02S050	
		10	252-K5103-02S100	
No Shield				
Connector style	Cable	Length(m)	Part number	
 Single-ended straight male	PUR	2	201-K5103-02S020	
		5	201-K5103-02S050	
		10	201-K5103-02S100	
 Single-ended straight female	PUR	2	202-K5103-02S020	
		5	202-K5103-02S050	
		10	202-K5103-02S100	
 Single-ended angled male	PUR	2	203-K5103-02S020	
		5	203-K5103-02S050	
		10	203-K5103-02S100	
 Single-ended angled female	PUR	2	204-K5103-02S020	
		5	204-K5103-02S050	
		10	204-K5103-02S100	

## M12 K-Code Device Circular Connector

### Front mounting with 0.5m wire

Male

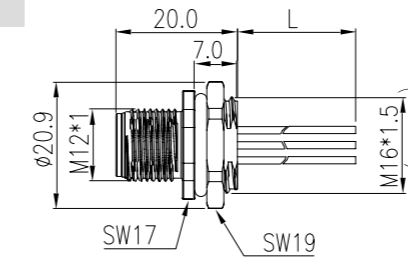

Female

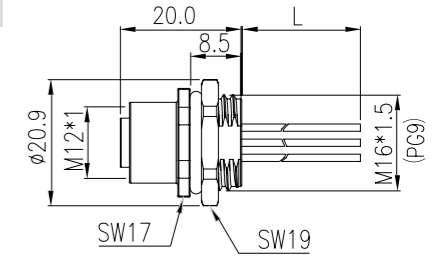

### Rear mounting with 0.5m wire

Male

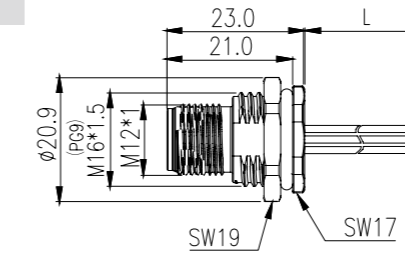

Female

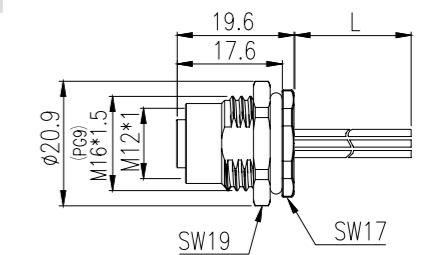







### Pin assignments and wire colors

Pin arrangement		
Pin out		5P
		K code
1		Black
2		Black
3		Black
4		Black
FE		Yellow Green

## M12 K-Code Device Connector

Mechanical Properties		Material Properties	
Min. Insertion/withdrawal cycles	100	Contact / contact surface	Copper alloy / Gold plated
Degree of protection	IP67	Contact carrier	PA
Operating Temperature	-40°C ~80°C	Hexagonal nut / Outer Shield	Zinc die-cast, nickel-plated
Fasten torque	0.4 Nm	O-ring	NBR
Mounting torque	0.8 Nm	UL94 Flammability rating	V0
Electrical Properties		Electrical Properties	
Rated voltage / current (contacts)	630VAC / 16A (5 Pin)	Cable Jacket	XLPE
Rated Impulse Voltage	4kV (5 Pin)	UL AWM style	UL AWM 3994
Insulation resistance	Min. 100MΩ	Conductor cross section	1.5mm <sup>2</sup> / 14AWG (5 Pin)
Overvoltage Category	III	Material conductor insulation	XLPE
Pollution Degree	3	Flame resistance	FT2
		Dielectric strength	6kV/1min
Standards and Regulations			
Design reference	IEC 61076-2-101: Detail specification for M12 connectors with screw-locking IEC 60512: Electromechanical components for electronic equipment; basic testing procedure and measuring methods IEC 60529: Degree of protection provided by enclosures (IP Code)		
Certification reference	UL 2237		
Notice			
The mechanical and electrical data performance can be ensured when the connector pair is correctly locked and fasten by specified torque. If the connector is not locked and or exposed in th contaminated enviroment, the connector must be sealed by the protective cover. Also, the influences from conductor, cable or PCB assembly must be taken into consideration.			

## M12 K-Code Device Connector ( No Shield )

Coding and contacts	Code	K	
	Contact	5(4+PE)	
Rated voltage / current		630V / 16A	
Contact arrangement		Male 	Male 
Front mounting with 0.5m wire			
Connector style	Mount thread	Part number	
Male 	M16x1.5	218-K5100-0MSL50	
Female 	M16x1.5	219-K5100-0MSL50	
Rear mounting with 0.5m wire			
Connector style	Mount thread	Part number	
Male 	M16x1.5	220-K5100-0MSL50	
Female 	M16x1.5	221-K5100-0MSL50	

The wire length can be customized. For more details, please contact Dinkle

## M12 M-Code Molded Circular Connector

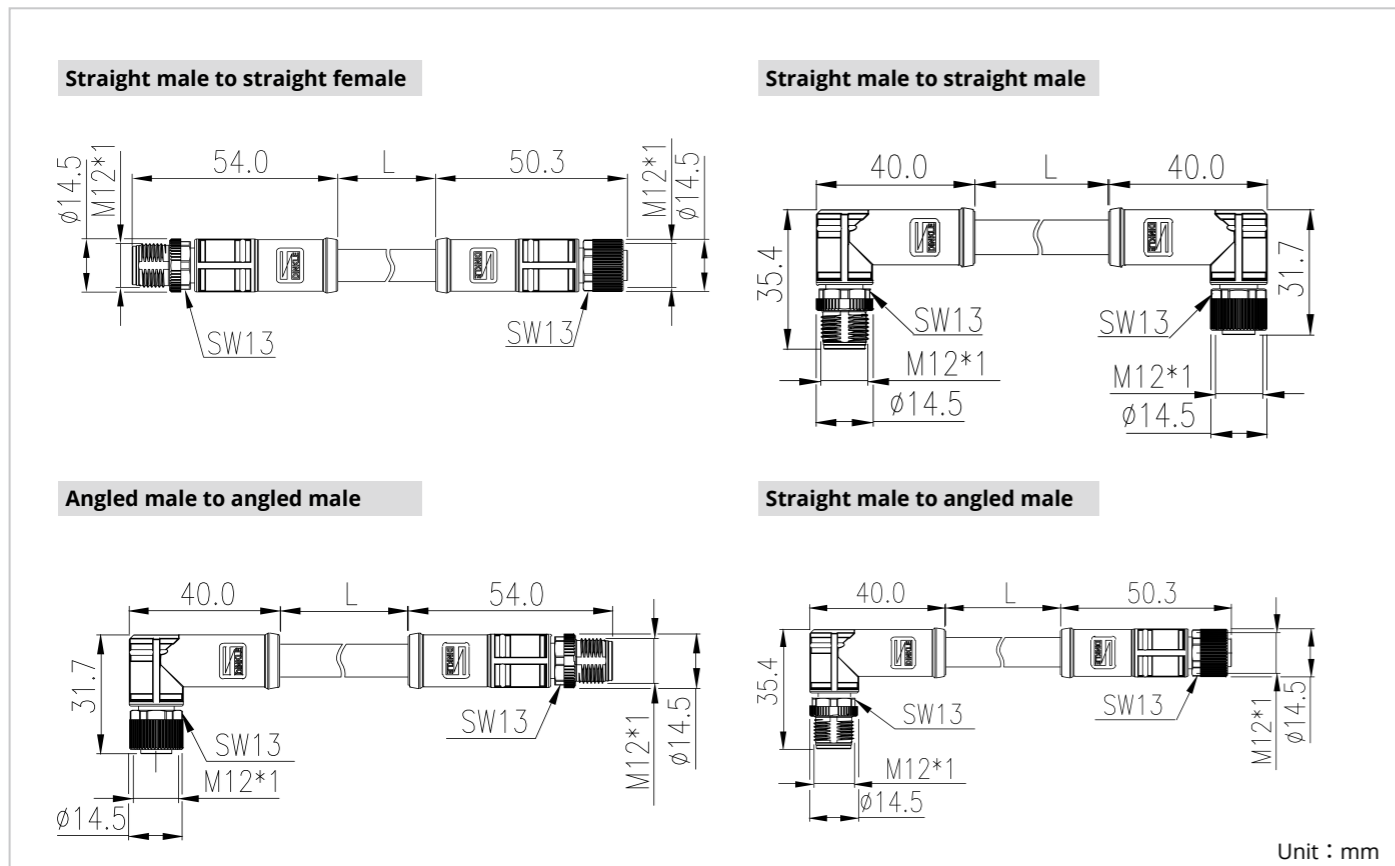
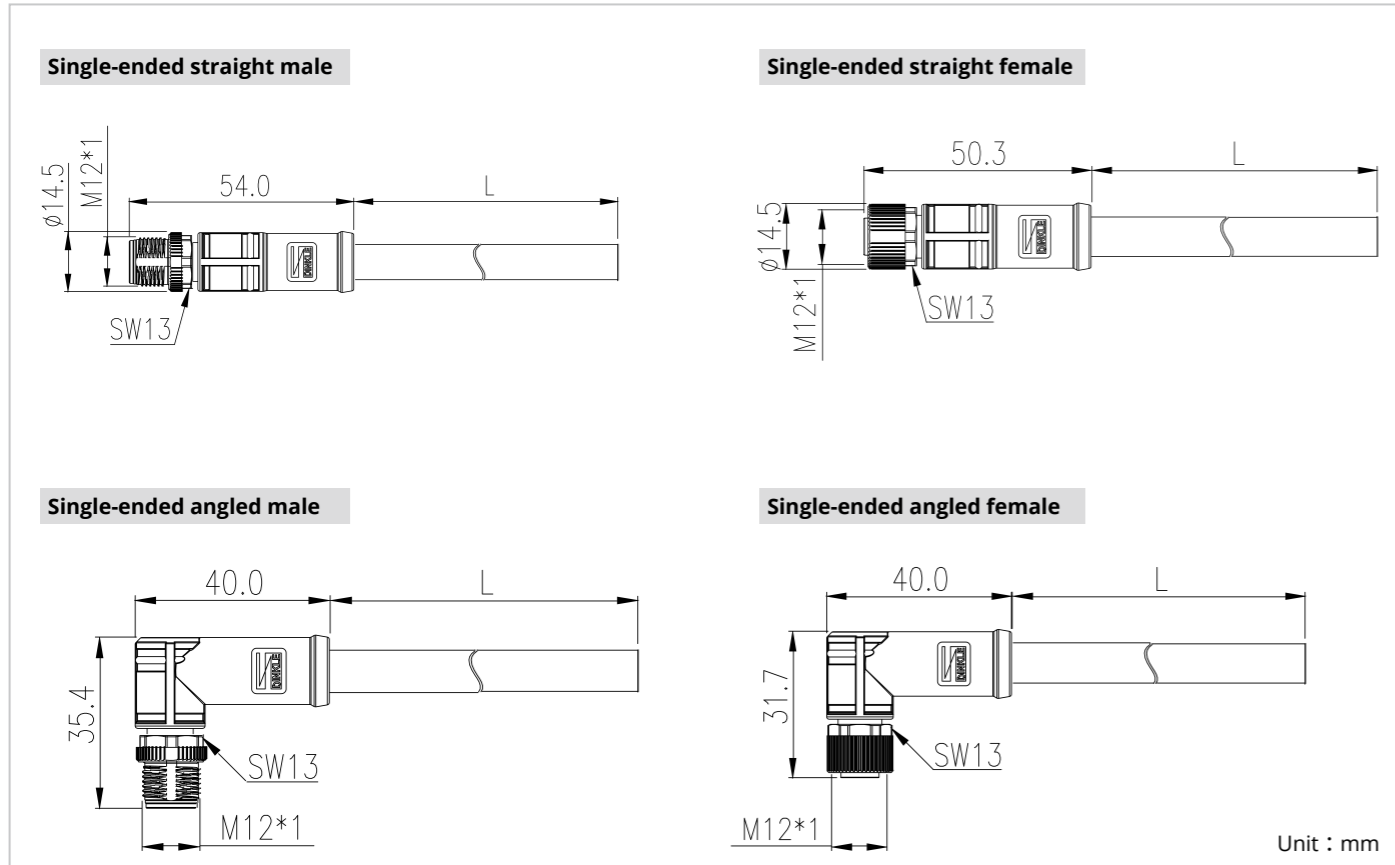









## M12 M-Code Molded Connector

Mechanical Properties		Material Properties		
Min. Insertion/withdrawal cycles	100	Contact / contact surface	Copper alloy / Gold plated	
Degree of protection	IP67	Contact carrier / overmolding	PA / PP	
Operating Temperature	-40°C ~ 80°C ( Fixed installation )	O-ring	NBR	
	-25°C ~ 80°C ( Flexible installation )	Cable gland material	Zinc die-cast, nickel-plated	
Fasten torque	0.4 Nm	UL94 Flammability rating	V0	
Electrical Properties		Cable Information		
Rated voltage / current (contacts)	630VAC / 8A (6 Pin)	Cable Jacket	No Shield	PUR, BLACK
Rated Impulse Voltage	6kV(6 Pin)		Shield	PUR,ORANGE
Insulation resistance	Min. 100MΩ	UL AWM style	No Shield	UL AWM 21223
Overvoltage Category	III		Shield	UL AWM 21223
Pollution Degree	3	Conductor cross section	1.5mm <sup>2</sup> / 16AWG(6 Pin)	
		Material conductor insulation	PP	
		Flame resistance	VW-1/FT1	
		Dielectric strength	3kV/min	
Standards and Regulations				
Design reference	IEC 61076-2-111: Circular connectors - Detail specification for power connectors with M12 screw-locking IEC 60512: Electromechanical components for electronic equipment; basic testing procedure and measuring methods IEC 60529: Degree of protection provided by enclosures (IP Code)			
Certification reference	UL 2237			

### Notice

The mechanical and electrical data performance can be ensured when the connector pair is correctly locked and fasten by specified torque. If the connector is not locked and or exposed in th contaminated enviroment, the connector must be sealed by the protective cover. Also, the influences from conductor, cable or PCB assembly must be taken into consideration.

## M12 M-Code Molded Connector ( Shield / No Shield)

Coding and contacts		Code	M	
Rated voltage / current			630V / 8A	
Contact arrangement			Male	Female
				
Shield				
Connector style	Cable	Length(m)	Part number	
	PUR	2	251-M6103-02S020	
		5	251-M6103-02S050	
		10	251-M6103-02S100	
	PUR	2	252-M6103-02S020	
		5	252-M6103-02S050	
		10	252-M6103-02S100	
No Shield				
Connector style	Cable	Length(m)	Part number	
	PUR	2	201-M6103-02S020	
		5	201-M6103-02S050	
		10	201-M6103-02S100	
	PUR	2	202-M6103-02S020	
		5	202-M6103-02S050	
		10	202-M6103-02S100	
	PUR	2	203-M6103-02S020	
		5	203-M6103-02S050	
		10	203-M6103-02S100	
	PUR	2	204-M6103-02S020	
		5	204-M6103-02S050	
		10	204-M6103-02S100	

## M12 M-Code Device Circular Connector

### Front mounting with 0.5m wire

Male

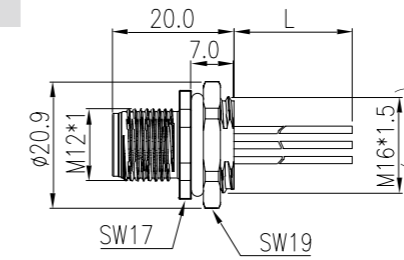

Female

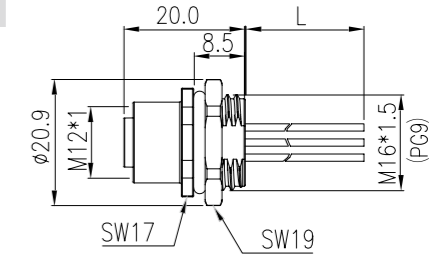

### Rear mounting with 0.5m wire

Male

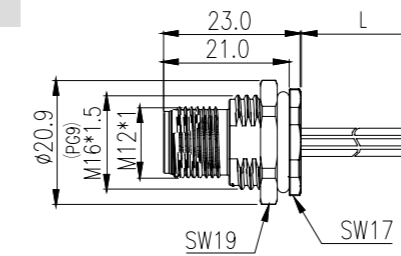

Female

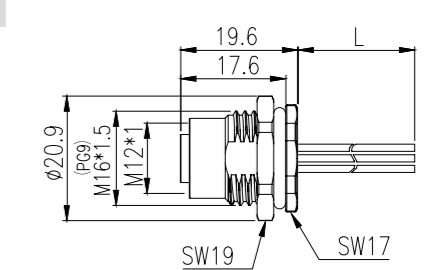



### Pin assignments and wire colors

Pin arrangement		
		6P
		M code
Pin out	1	Black
	2	Black
	3	Black
	4	Black
	FE	Yellow Green

## M12 M-Code Device Connector

Mechanical Properties		Material Properties	
Min. Insertion/withdrawal cycles	100	Contact / contact surface	Copper alloy / Gold plated
Degree of protection	IP67	Contact carrier	PA
Operating Temperature	-40°C ~80°C	Hexigonal nut / Outer Shield	Zinc die-cast, nickel-plated
Fasten torque	0.4Nm	O-ring	NBR
Mounting torque	0.8Nm	UL94 Flammability rating	V0
Electrical Properties		Cable Information	
Rated voltage / current (contacts)	630VAC / 8A(6 Pin)	Cable Jacket	MPPE
Rated Impulse Voltage	6kV(6 Pin)	UL AWM style	UL 11029
Insulation resistance	Min. 100MΩ	Conductor cross section	1.5mm <sup>2</sup> / 16AWG(6 Pin)
Overvoltage Category	III	Material conductor insulation	MPPE
Pollution Degree	3	Flame resistance	VW-1 / FT1
		Dielectric strength	3kV/1min
Standards and Regulations			
Design reference	IEC 61076-2-101: Detail specification for M12 connectors with screw-locking		
	IEC 60512: Electromechanical components for electronic equipment; basic testing procedure and measuring methods		
	IEC 60529: Degree of protection provided by enclosures (IP Code)		
Certification reference	UL 2237		
Notice			
The mechanical and electrical data performance can be ensured when the connector pair is correctly locked and fasten by specified torque. If the connector is not locked and or exposed in th contaminated enviroment, the connector must be sealed by the protective cover. Also, the influences from conductor, cable or PCB assembly must be taken into consideration.			

## M12 M-Code Device Connector ( No Shield )

Coding and contacts	Code	M	
	Contact	6(5+PE)	
Rated voltage / current		630V / 8A	
Rated voltage / current		Male 	Female 
Front mounting with 0.5m wire			
Connector style	Mount thread	Part number	
Male 	M16x1.5	218-M6100-0MSL50	
Female 	M16x1.5	219-M6100-0MSL50	
Rear mounting with 0.5m wire			
Connector style	Mount thread	Part number	
Male 	M16x1.5	220-M6100-0MSL50	
Female 	M16x1.5	221-M6100-0MSL50	

The wire length can be customized. For more details, please contact Dinkle

# M23 Circular Connector

The M23 circular connectors offer a versatile industrial connection solution, primarily used for integrating electrical drives and servo motors into industrial automation equipment. These connectors are equally suitable for applications involving signal or power transmission, thanks to their high current and voltage carrying capabilities. They are designed to withstand harsh environments and complex application scenarios.

Additionally, Dinkle provides a variety of pin configurations, including 6, 12, 17, and 19 pins, to meet your application needs, whether for power or signal adaptation.



## M23 N-Code Circular Connector

**Straight male - power**

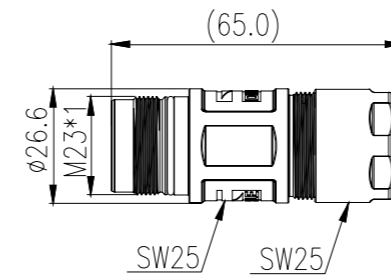

**Angled male - power**

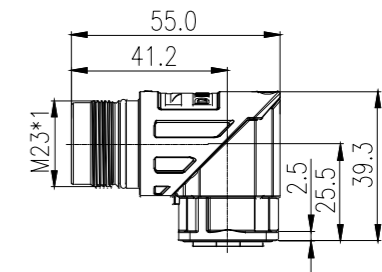

**Straight female - power**

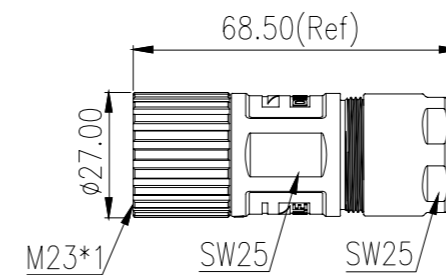

**Straight male - Signal**

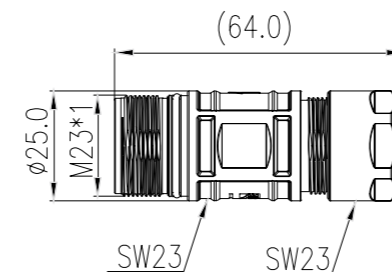

**Straight female - Signal**

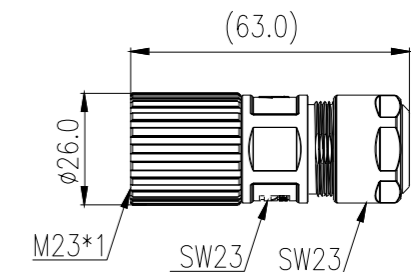





Unit : mm

## M23 N-Code Circular Connector

Mechanical Properties		Material Properties	
Min. Insertion/withdrawal cycles	100	Contact / contact surface	Copper alloy / Gold plated
Degree of protection	IP67	Contact carrier	PA
Operating Temperature	-40°C ~ 125°C	Outer Shield	Zinc Alloy
Fasten torque	Crimping	O-ring	NBR
		UL94 Flammability rating	V0
Electrical Properties		Cable Information	
Electrical Properties	630VAC / 30A(6 Pin)	Wiring diameter	Power 0.25mm <sup>2</sup> ~4.0mm <sup>2</sup>
	200VAC / 8A (12 Pin)		Signal 0.08mm <sup>2</sup> ~1.0mm <sup>2</sup>
	200VAC / 8A (17 Pin)	Applicable cable diameter	Power 5.5mm <sup>2</sup> ~17.0mm <sup>2</sup>
	48VAC (19 Pin) / 8A(φ1.0mm <sup>2</sup> ) & 10A(φ1.5mm <sup>2</sup> ) 78VDC (19 Pin) / 8A(φ1.0mm <sup>2</sup> ) & 10A(φ1.5mm <sup>2</sup> )		Signal 3.0mm <sup>2</sup> ~14.0mm <sup>2</sup>
Electrical Properties	6kV(6 Pin)		
	1.5kV(12, 17, 19 Pin)		
Insulation resistance	Min. 100MΩ		
Overvoltage Category	III		
Pollution Degree	3		
Standards and Regulations			
Certification reference	UL1977 / UL2238 (Circular Connector Signal)		
Notice			
The mechanical and electrical data performance can be ensured when the connector pair is correctly locked and fasten by specified torque. If the connector is not locked and or exposed in th contaminated enviroment, the connector must be sealed by the protective cover. Also, the influences from conductor, cable or PCB assembly must be taken into consideration.			







## M23 N-Code Circular Connector Power

Coding and contacts	Code	N	
	Contact	6(5+PE)	
Rated voltage / current		630V/30A	
Contact arrangement		Male 	Female 
Cable end			
Connector style	terminal	Part number	
Straight male thread 	turning soldering male terminal	401-P0061	
Straight female thread 	turning soldering female terminal	402-P0062	
Device side			
Connector style	terminal	Part number	
Angled male thread 	turning soldering male terminal	426-P0061	

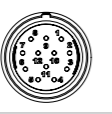
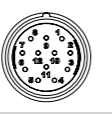
## Crimp terminal

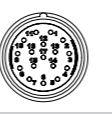
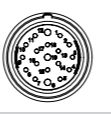
Terminal diameter Ø 2 mm	Crimp wiring diameter mm <sup>2</sup>	Part number	
		Turning male terminal	Turning female terminal
	0.25 - 1.0	0304-0304	0304-1304
	1.5 - 2.5	0304-0305	0304-1305
	2.5 - 4	0304-0306	0304-1306

## M23 N-Code Circular Connector Signal

Coding and contacts	Code	N		N		N	
	Contact	12		17		19	
Rated voltage / current		200V/8A		200V/8A		78V/10A	
Rated voltage / current		Male	Female	Male	Female	Male	Female
							
<b>Cable end</b>							
Connector style	terminal	Part number					
	turning soldering male terminal	401-S0123	401-S0173	401-S0193			
	turning soldering female terminal	401-S0124	401-S0174	401-S0194			
	turning soldering male terminal	402-S0123	402-S0173	402-S0193			
	turning soldering female terminal	402-S0124	402-S0174	402-S0194			

Crimp terminals are available in different sizes depending on the crimpable wire size and can be sold separately

# 7/8" Circular Connector

Dinkle's 7/8" circular connector series is specifically designed for power supply in industrial automation fieldbus networks. The series offers 2 to 6 terminals, with a maximum capacity of 600V/13A, making it a reliable power source for industrial communication equipment. For example, 5-pin connectors are commonly used for PROFIBUS/PROFINET, while 4-pin ones are suited for DeviceNet applications. These connectors maximize power delivery within limited space and provide stable transmission and power sources for components and equipment used in factory and warehouse automation applications.

Dinkle's overmolded circular connectors simplify fieldbus installation, reduce wiring errors during field connections, and ensure proper component connectivity and reliable communication. Panel-mounted circular connectors, fixed to equipment or enclosures using nuts, achieve IP68 protection for excellent environmental resistance. The one-piece PCB circular connectors, with their integrated design and high protection rating, have become a preferred choice in industrial connection solutions.



## 7/8" A-Code Molded Circular Connector

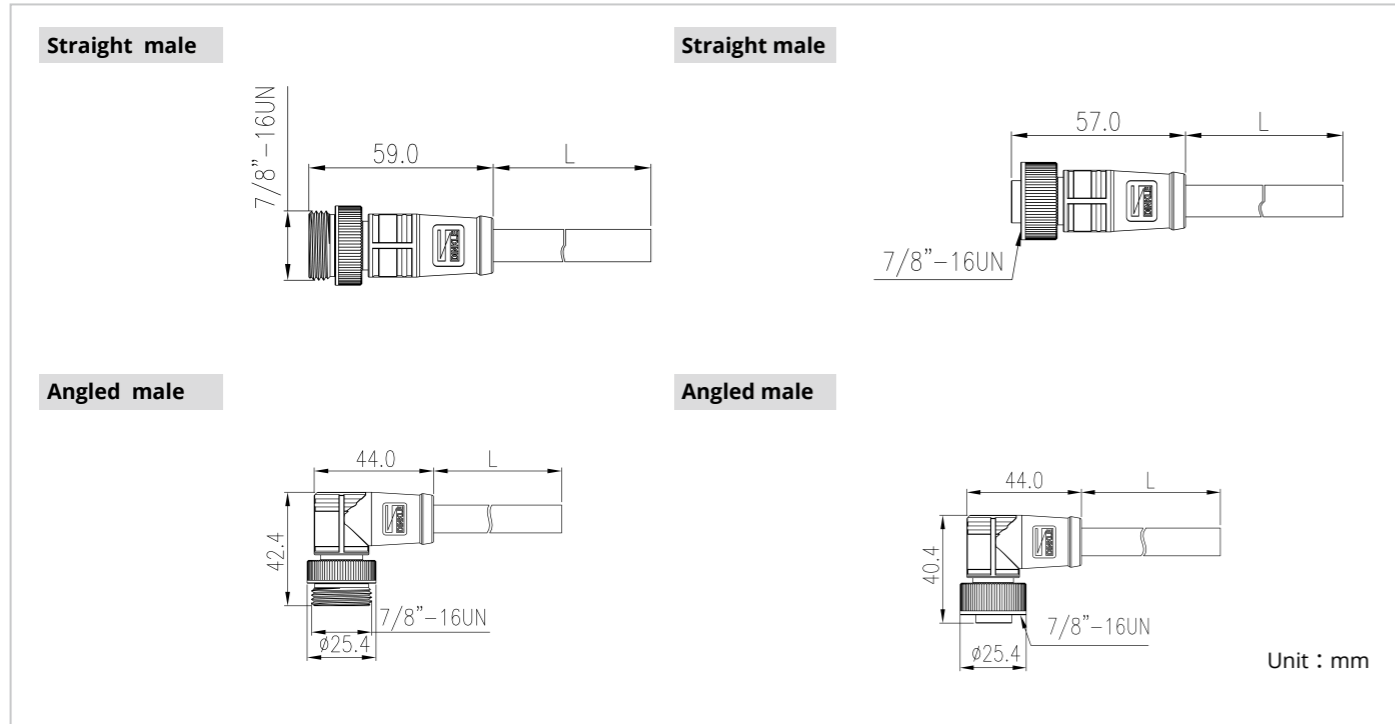

## 7/8" A-Code Molded Connector

Mechanical Properties		Rated Impulse Voltage	
Min. Insertion/withdrawal cycles	100	Contact / contact surface	Copper alloy / Gold plated
Degree of protection	IP68	Contact carrier / overmolding	PVC / PVC
Operating Temperature	-30°C ~ 105°C ( Fixed installation )	O-ring	NBR
	-40°C ~ 105°C ( Flexible installation )	Cable gland material	Zinc die-cast, nickel-plated
Fasten torque	1.12 Nm	UL94 Flammability rating	V0
Electrical Properties		Cable Information	
Electrical Properties	600VAC / 13A (≤3 Pin)	Cable Jacket	PVC, Yellow
	600VAC / 10A (4 Pin)	UL AWM style	No Shield   PVC : STOOW
	600VAC / 8A (5 Pin)	Conductor cross section	16AWG (≤6 Pin)
	600VAC / 8A (6 Pin)	Material conductor insulation	PVC
Rated Impulse Voltage	2.5kV	Flame resistance	VW-1
Insulation resistance	Min. 100MΩ	Dielectric strength	NA
Overvoltage Category	II		
Pollution Degree	3		
Standards and Regulations			
Certification reference	UL2238		
Notice			
The mechanical and electrical data performance can be ensured when the connector pair is correctly locked and fasten by specified torque. If the connector is not locked and or exposed in th contaminated enviroment, the connector must be sealed by the protective cover. Also, the influences from conductor, cable or PCB assembly must be taken into consideration.			

## 7/8" A-Code Molded Connector ( No Shield )

Coding and contacts	Code	A		A		A		A			
	Contact	2		3		4		5		6	
Rated voltage / current		600V / 13A		600V / 13A		600V / 10A		600V / 8A		600V / 8A	
Rated voltage / current		Male	Female	Male	Female	Male	Female	Male	Female	Male	Female
Connector style	Cable	Length(m)		Part number							
Single-ended straight male	PVC	2m	451-2000-0020	451-3000-0020	<b>451-4000-0020</b>	<b>451-5000-0020</b>	451-6000-0020				
		5m	451-2000-0050	451-3000-0050	<b>451-4000-0050</b>	<b>451-5000-0050</b>	451-6000-0050				
		10m	451-2000-0100	451-3000-0100	<b>451-4000-0100</b>	<b>451-5000-0100</b>	451-6000-0100				
Single-ended straight female	PVC	2m	452-2000-0020	452-3000-0020	<b>452-4000-0020</b>	<b>452-5000-0020</b>	452-6000-0020				
		5m	452-2000-0050	452-3000-0050	<b>452-4000-0050</b>	<b>452-5000-0050</b>	452-6000-0050				
		10m	452-2000-0100	452-3000-0100	<b>452-4000-0100</b>	<b>452-5000-0100</b>	452-6000-0100				
Single-ended angled male	PVC	2m	453-2000-0020	453-3000-0020	<b>453-4000-0020</b>	<b>453-5000-0020</b>	453-6000-0020				
		5m	453-2000-0050	453-3000-0050	<b>453-4000-0050</b>	<b>453-5000-0050</b>	453-6000-0050				
		10m	453-2000-0100	453-3000-0100	<b>453-4000-0100</b>	<b>453-5000-0100</b>	453-6000-0100				
Single-ended angled female	PVC	2m	454-2000-0020	454-3000-0020	<b>454-4000-0020</b>	<b>454-5000-0020</b>	454-6000-0020				
		5m	454-2000-0050	454-3000-0050	<b>454-4000-0050</b>	<b>454-5000-0050</b>	454-6000-0050				
		10m	454-2000-0100	454-3000-0100	<b>454-4000-0100</b>	<b>454-5000-0100</b>	454-6000-0100				
Straight male mate straight female	PVC	0.6m	456-2000-0L60	456-3000-0L60	<b>456-4000-0L60</b>	<b>456-5000-0L60</b>	456-6000-0L60				
		1.5m	456-2000-0015	456-3000-0015	<b>456-4000-0015</b>	<b>456-5000-0015</b>	456-6000-0015				
		3m	456-2000-0030	456-3000-0030	<b>456-4000-0030</b>	<b>456-5000-0030</b>	456-6000-0030				
Angled male mate angled female	PVC	0.6m	459-2000-0L60	459-3000-0L60	<b>459-4000-0L60</b>	<b>459-5000-0L60</b>	459-6000-0L60				
		1.5m	459-2000-0015	459-3000-0015	<b>459-4000-0015</b>	<b>459-5000-0015</b>	459-6000-0015				
		3m	459-2000-0030	459-3000-0030	<b>459-4000-0030</b>	<b>459-5000-0030</b>	459-6000-0030				

The configuration of connectors and the cable length can be customized. For more details, please contact Dinkle  
**Bolded part number is cULus certified.**

## 7/8" A-Code Device Circular Connector

### Front mounting with 0.5m wire

Male

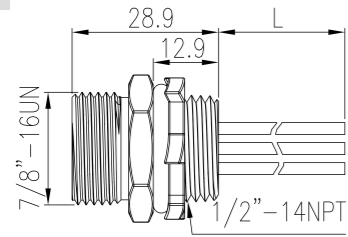

Female

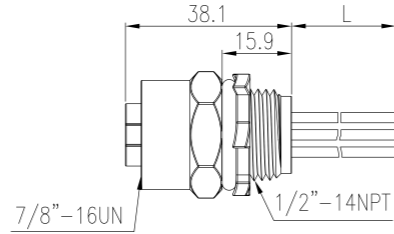

### Pin assignments and wire colors

Pin arrangement	2P		3P		4P		5P	
	A code							
Pin out	1	White	1	Green	1	Black	1	White
	2	Black	2	Black	2	White	2	Red
			3	White	3	Red	3	Green
					4	Green	4	Orange
							5	Black

## 7/8" A-Code Device Connector

Mechanical Properties		Material Properties	
Min. Insertion/withdrawal cycles	100	Contact / contact surface	Copper alloy / Gold plated
Degree of protection	IP67	Contact carrier	PA
Operating Temperature	-40°C ~ 80°C	Hexagonal nut / Outer Shield	Zinc die-cast, nickel-plated
Fasten torque	1.1Nm	O-ring	NBR
Mounting torque	1.5 Nm	UL94 Flammability rating	V0
Electrical Properties		Cable Information	
Rated voltage / current (contacts)	600VAC / 13A (≤3 Pin)	Cable Jacket	MPPE
	600VAC / 10A (4 Pin)	Cable Jacket	MPPE : UL11029
	600VAC / 8A (5 Pin)	Cable Jacket	16AWG (≤6 Pin)
	600VAC / 8A (6 Pin)	Material conductor insulation	MPPE
Rated Impulse Voltage	2.5kV	Flame resistance	VW-1
Insulation resistance	Min. 100MΩ	Dielectric strength	NA
Overvoltage Category	II		
Pollution Degree	3		
Standards and Regulations			
Certification reference	UL2238		

### Notice

The mechanical and electrical data performance can be ensured when the connector pair is correctly locked and fasten by specified torque. If the connector is not locked and or exposed in th contaminated enviroment, the connector must be sealed by the protective cover. Also, the influences from conductor, cable or PCB assembly must be taken into consideration.

## 7/8" A-Code Device Connector ( No Shield )

Coding and contacts	Code Contact	A 2		A 3		A 4		A 5		A 6	
		Male	Female	Male	Female	Male	Female	Male	Female	Male	Female
Rated voltage / current		600V / 13A		600V / 13A		600V / 10A		600V / 8A		600V / 8A	
Contact arrangement											
Front mounting with 0.5m wire											
Connector style	Mount thread	Part number									
Male	1/2"-14NPT	468-2006-0L50	468-3006-0L50	<b>468-4006-0L50</b>	<b>468-5006-0L50</b>	468-6006-0L50					
Male	1/2"-14NPT	469-2006-0L50	469-3006-0L50	<b>469-4006-0L50</b>	<b>469-5006-0L50</b>	469-6006-0L50					

The wire length can be customized. For more details, please contact Dinkle  
**Bolded part number is cULus certified.**

## 7/8" A-Code One-piece PCB Circular Connector

### 180° Rear mounting, straight (NonShielded)

Male		PCB Layout	
	Pin out		
	Pin arrangement	 4P	 5P
		A-code	
Female		PCB Layout	
	Pin out		
	Pin arrangement	 4P	 5P
		A-code	

## 7/8" A-Code One-piece PCB Connector ( No Shield )

Coding and contacts	Code Contact	A		A	
		4		5	
Rated voltage / current		600V / 10A		600V / 8A	
Contact arrangement		Male	Female	Male	Female
Rear mounting, straight, No Shield					
Connector style	Mount thread	Part number			
 Male	1/2"-14NPT	476-4000-8		476-5000-8	
 Female	1/2"-14NPT	477-4000-8		477-5000-8	

## 7/8" A-Code One-piece PCB Circular Connector

Mechanical Properties		Material Properties	
Min. Insertion/withdrawal cycles	100	Contact / contact surface	Copper alloy / Gold plated
Degree of protection	IP68	Contact carrier	PVC
Operating Temperature	-40°C ~ 105°C	Hexigonal nut / Outer Shield	Brass alloy, nickel-plated / Zinc die-cast, nickel-plated
Fasten torque	1.12Nm	O-ring	Zinc die-cast, nickel-plated
Soldering method	Wave Soldering	UL94 Flammability rating	V0
Electrical Properties		Cable Information	
Rated voltage / current (contacts)	600VAC / 10A (4 Pin)		
	600VAC / 8A (5 Pin)		
Rated Impulse Voltage	2.5kV (≤6 Pin)		
Insulation resistance	Min. 100MΩ		
Overvoltage Category	II		
Pollution Degree	3		
Standards and Regulations			
Certification reference	UL2238		
Notice			
The mechanical and electrical data performance can be ensured when the connector pair is correctly locked and fasten by specified torque. If the connector is not locked and or exposed in th contaminated enviroment, the connector must be sealed by the protective cover. Also, the influences from conductor, cable or PCB assembly must be taken into consideration.			

## Distribution Box

Effective and flexible cabling



### Status indicator

Single / Double slots and 4 / 6 / 8 sockets are available.

### M12 connector

Standardized M12 A-Code connector according to IEC 61076-2-101.

### Clear marking

Quick and convenient marking with DINKLE TM-R series.

### High quality cable

PUR/PVC sheathed cables for various industrial environment.

## Related products

Style	Sheath	Length (m)	Part number	Style	Sheath	Length (m)	Part number
M12 - Single-ended straight male	PUR	2	201-A5000-00S020	M12 - Single-ended angled male	PUR	2	203-A5000-00S020
		5	201-A5000-00S050			5	203-A5000-00S050
		10	201-A5000-00S100			10	203-A5000-00S100
	PVC	2	201-A5000-20S020		PVC	2	203-A5000-20S020
		5	201-A5000-20S050			5	203-A5000-20S050
		10	201-A5000-20S100			10	203-A5000-20S100
M12 - Straight male to straight female	PUR	0.6	206-A5000-00SL60	M12 - Angled male to angled female	PUR	0.6	209-A5000-00SL60
		1.5	206-A5000-00S015			1.5	209-A5000-00S015
		3	206-A5000-00S030			3	209-A5000-00S030
	PVC	0.6	206-A5000-20SL60		PVC	0.6	209-A5000-20SL60
		1.5	206-A5000-20S015			1.5	209-A5000-20S015
		3	206-A5000-20S030			3	209-A5000-20S030
M12 - Straight male to angled female	PUR	0.6	212-A5000-00SL60	M12 - Angled male to straight female	PUR	0.6	214-A5000-00SL60
		1.5	212-A5000-00S015			1.5	214-A5000-00S015
		3	212-A5000-00S030			3	214-A5000-00S030
	PVC	0.6	212-A5000-20SL60		PVC	0.6	214-A5000-20SL60
		1.5	212-A5000-20S015			1.5	214-A5000-20S015
		3	212-A5000-20S030			3	214-A5000-20S030
M12 - Y-splitter with cable	PUR	0.15	222-A5530-00SL15	M12 - Y-splitter without cable	<b>Part number</b>		
	PVC	0.15	222-A5530-20SL15		224-2A5100		
M23 - Cable side connector	<b>Contacts</b>	<b>Suitable Slot</b>	<b>Part number</b>	M12 - Plastic sealing cap	<b>Part number</b>		
			12		Single	402-S0124	200-A002
			19		Double	402-S0194	
Thermal printer	<b>Part number</b>			Continuous flat marking label	<b>Width(mm)</b>	<b>Part number</b>	
	TMP-004				7.4	TM-R100	
					9.8	TM-R200	

## Distribution Box

### Molded Master Cable

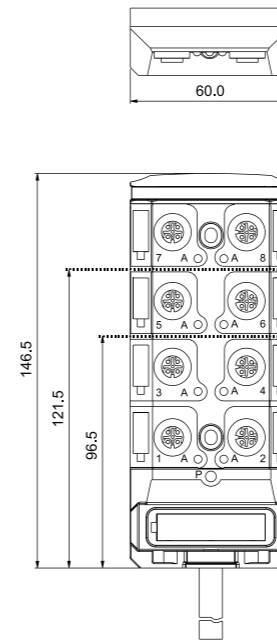

### Pluggable M23 Connector

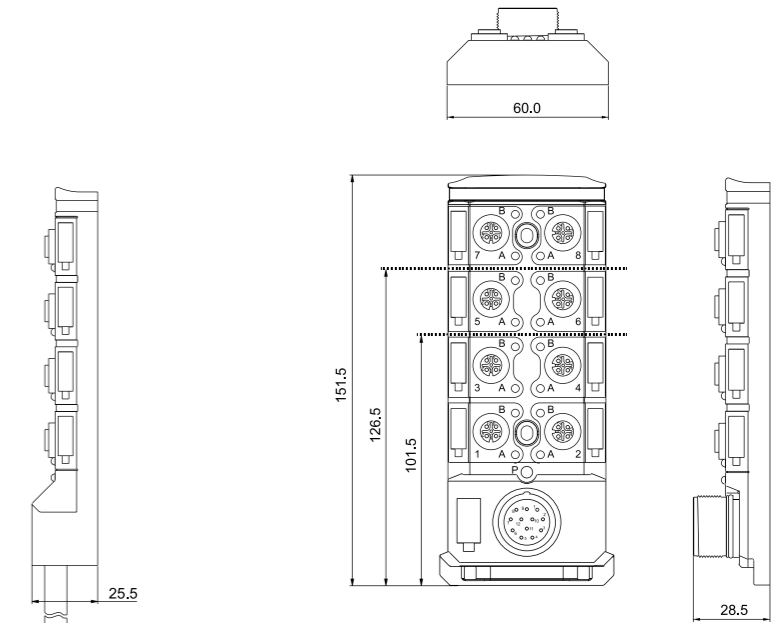

## Application

Optimize the wiring of I/O module and PLC in the control cabinet/box. Distribution boxes bundle 4/6/8 sensors or actuators into one master connection. Minimizing the risk of error to wire in the field.

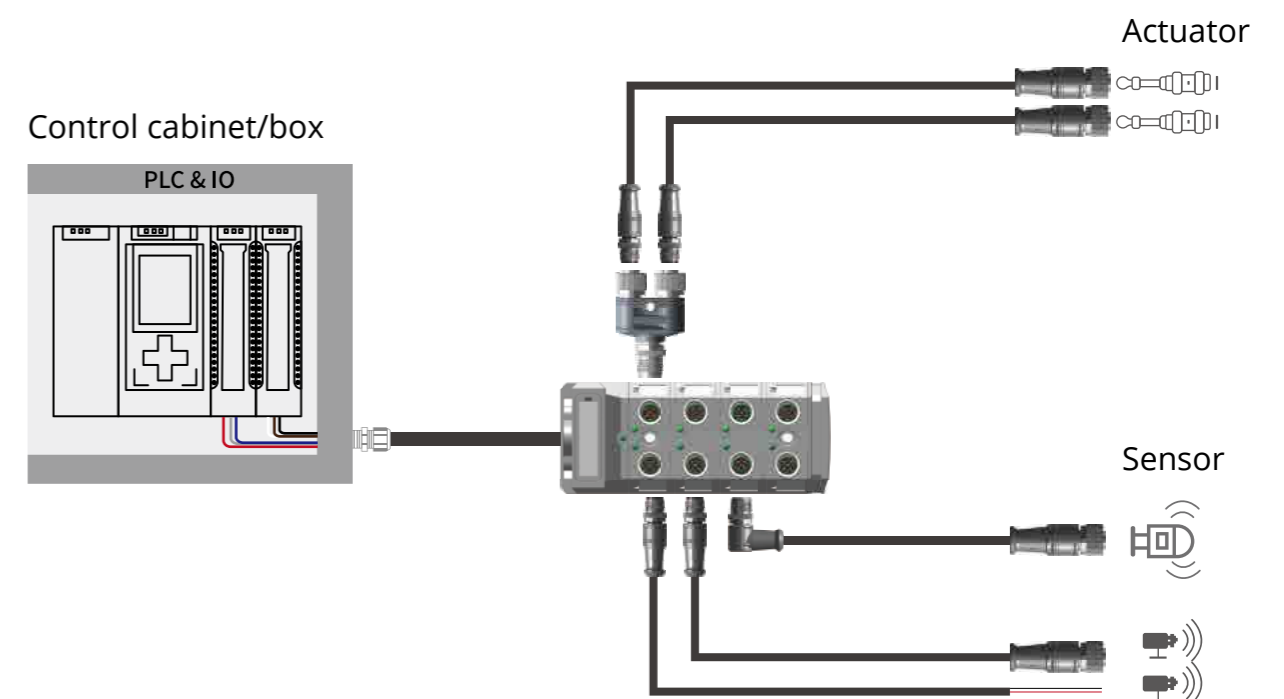

## Distribution Box

### Molded Master Cable

Ease of the installation process in the field.  
The cable length can be customized.



Sheath	Slot style	Single			Double		
	Sockets	6			8		
Length(m)		Part number					
PUR	5	953-04P-0050	953-06P-0050	953-08P-0050	954-04P-0050	954-06P-0050	954-08P-0050
PUR	10	953-04P-0100	953-06P-0100	953-08P-0100	954-04P-0100	954-06P-0100	954-08P-0100
PVC	5	953-04P-3050	953-06P-3050	953-08P-3050	954-04P-3050	954-06P-3050	954-08P-3050
PVC	10	953-04P-3100	953-06P-3100	953-08P-3100	954-04P-3100	954-06P-3100	954-08P-3100
General parameter							
Socket style		M12 A-Code sockets			Shielded		No
Status indicator		Power: Green LED, I/O: Yellow LED			Signal type		PNP
Operation temp.		-25 ~ 80°C			IP rating		IP68
Electric parameter							
Rated voltage		24 VDC			Total rated current		12A
Max. current per path		2A			Max. current per slot		4A
Cable parameter							
Cable cores		7	10	12	11	15	19
Conductor size		4 x 0.34mm <sup>2</sup> 3 x 0.75mm <sup>2</sup>	4 x 0.34mm <sup>2</sup> 6 x 0.75mm <sup>2</sup>	4 x 0.34mm <sup>2</sup> 8 x 0.75mm <sup>2</sup>	8 x 0.5mm <sup>2</sup> 3 x 1mm <sup>2</sup>	12 x 0.5mm <sup>2</sup> 3 x 1mm <sup>2</sup>	16 x 0.5mm <sup>2</sup> 3 x 1mm <sup>2</sup>

### Pluggable M23 Connector

Suitable for frequent connection or module replacement



Slot style	Single			Single			
	Sockets	4			8		
Part number		951-04P			952-04P		
		951-06P	951-08P	952-06P	952-08P		
General parameter							
Socket style		M12 A-Code sockets			Shielded		No
Status indicator		Power: Green LED, I/O: Yellow LED			Signal type		PNP
Operation temp.		-25 ~ 80°C			IP rating		IP68
Electric parameter							
Rated voltage		24 VDC			Total rated current		12A
Max. current per path		2A			Max. current per slot		4A
Contacts of M23 connector		12			Contacts of M23 connector		19

# M12 Circular Connector - Industrial Ethernet



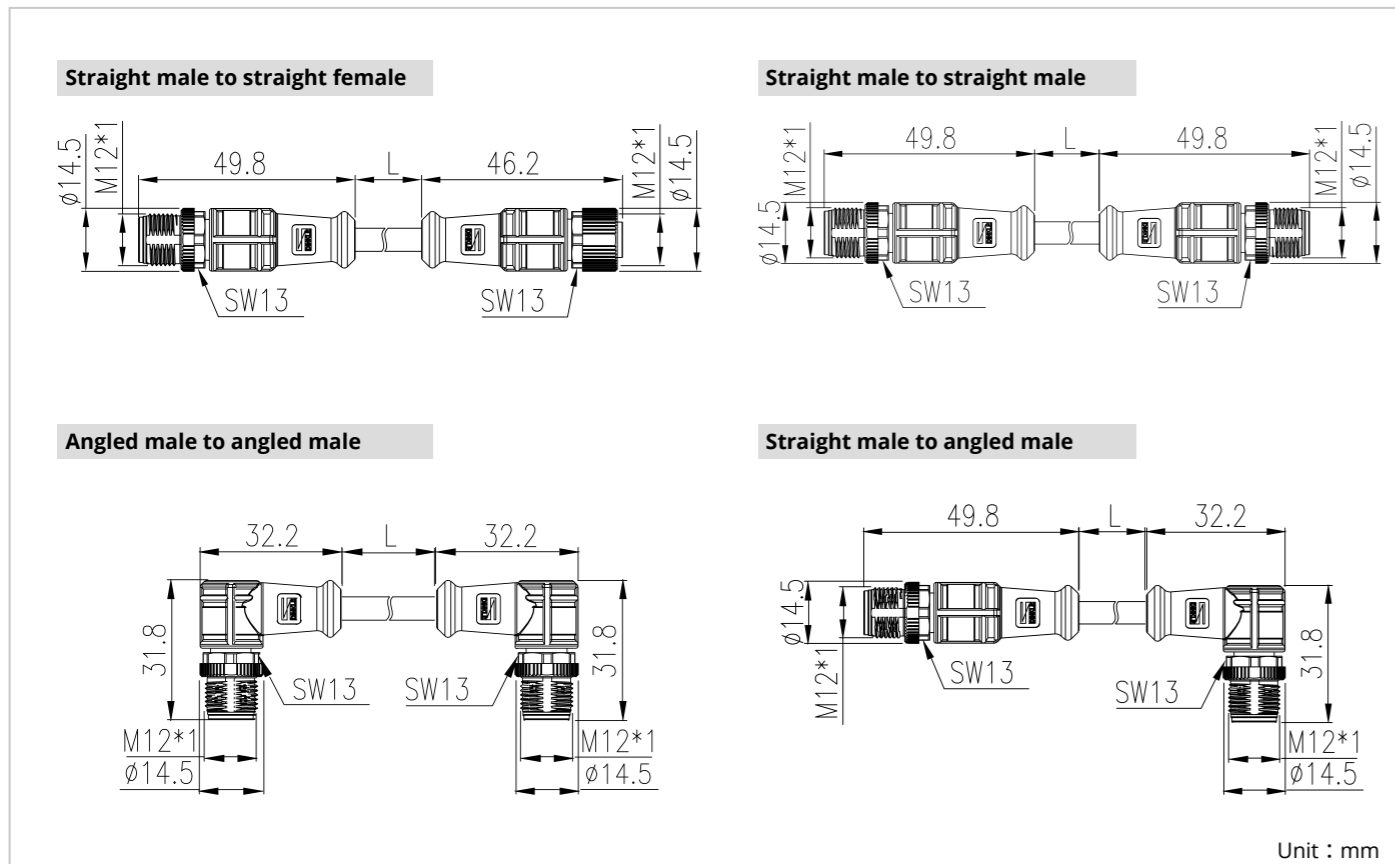
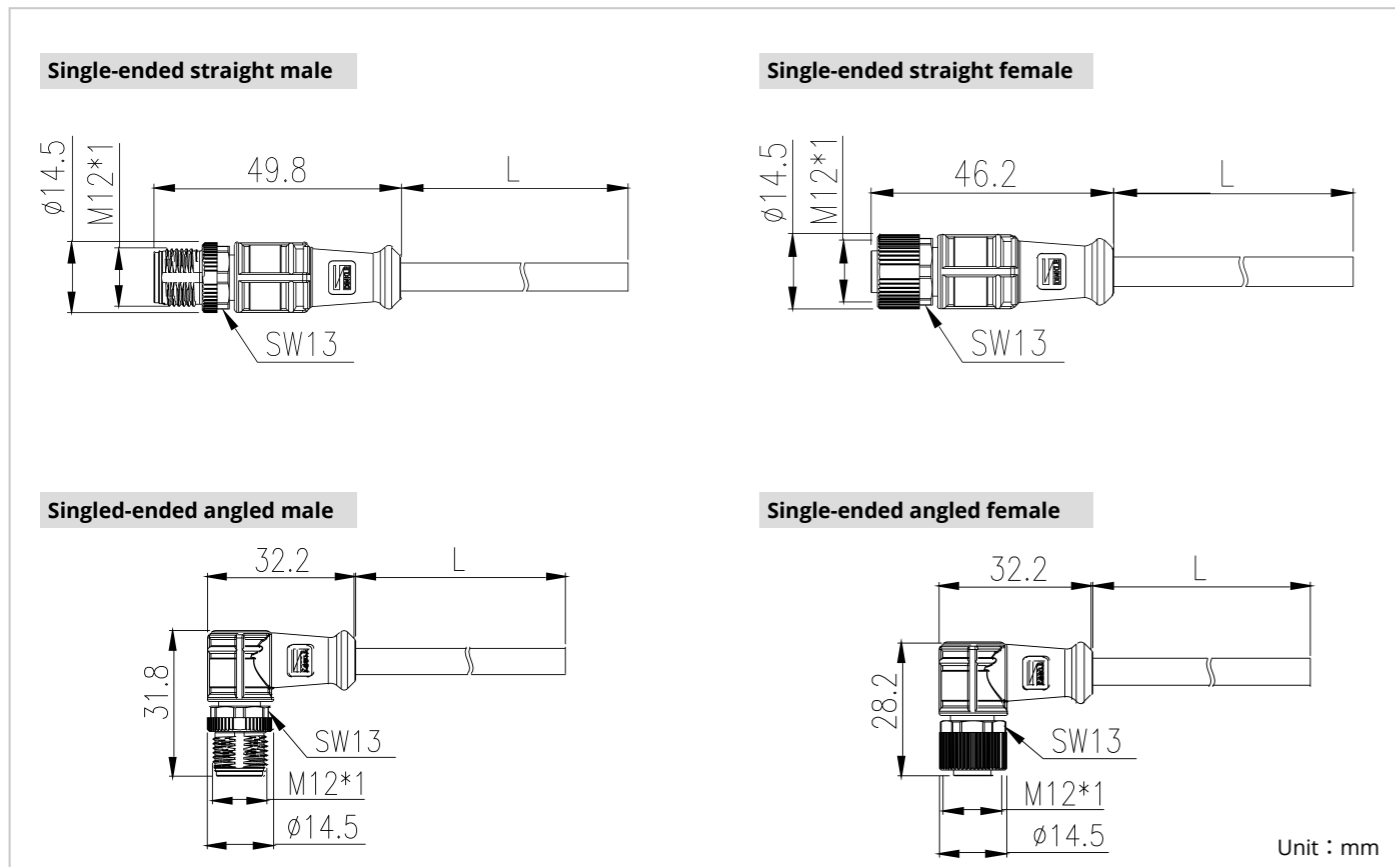

Dinkle offers M12 connectors designed for industrial communication protocols (such as CC-Link, DeviceNet/CANopen, Profibus DP, Profinet, Ethernet, EtherCAT5), meeting the demands of sensors and actuators in industrial automation systems and ensuring stable network communication. Its high-quality industrial network cables feature excellent shielding and transmission performance, offering IP67 protection to effectively prevent environmental interference. Additionally, Dinkle provides panel-mounted circular connectors with IP68 protection and one-piece PCB circular connectors that offer easy installation, reliable performance, and durability, making them suitable for various industrial environments.

Protocol	Code	Contact	Application	Data transfer rate	Cable profile	Connector Pinout
Networks	Ethernet CAT5e	A	8	All industrial environment	Up to 1 Gbps	 Pin   Conductor color   Signal 1   WH/BU   D3- 2   WH/BN   D4+ 3   BN   D4- 4   OG   D1- 5   WH/GN   D2+ 6   WH/OG   D1+ 7   BU   D3+ 8   GN   D2-
	PROFINET CAT5	D	4	Production in the automotive industry, process automation	100 Mbps	 Pin   Conductor color   Signal 1   YE   TD+ 2   WH   RD+ 3   OG   TD- 4   BU   RD-
	Ethernet CAT5 EtherNet/IP	D	4	Industrial automation and process control environments	Up to 100 Mbps	 Pin   Conductor color   Signal 1   WH/OG   TD+ 2   WH/GN   RD+ 3   OG   TD- 4   GN   RD- Shield on housing
	"Ethernet CAT6A"	X	8	Camera, CCTV and high speed data acquisition	Up to 10 Gbps	 Pin   Conductor color   Signal 1   WH/OG   D1+ 2   OG   D1- 3   WH/GN   D2+ 4   N   D2- 5   WH/BN   D4+ 6   BN   D4- 7   WH/BU   D3- 8   BU   D3+
Fieldbuses	CC-Link	A	4	Field of process	Up to 10 Mbps	 Pin   Conductor color   Signal 1   Shield   SLD 2   WH   DS 3   YE   DG 4   BU   DA
	DeviceNet CANopen	A	5	Automation and device control	DeviceNet: Up to 500kbaud  Canopen: 10 kbaud to 1 Mbaud	 Pin   Conductor color   Signal 1   Shield   Drain 2   RD   V+ 3   BK   V- 4   WH   CAN_H 5   BU   CAN_L Shield on housing
	PROFIBUS DP	B	5	Distributed I/O device	Up to 12 Mbp	 Pin   Conductor color   Signal 1   -   Acable 2   GN   Acable 3   -   Bcable 4   RD   Bcable 5   Flexible filler Shield on housing







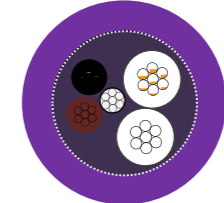
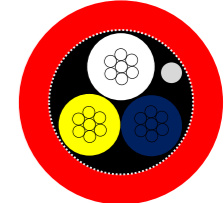

## M12 A-Code Molded Circular Connector - Industrial Ethernet

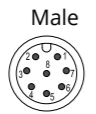
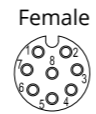

## M12 A-Code Molded Connector - Industrial Ethernet







	Ethernet	DeviceNet / CANopen	CC-Link
Protocols	 Ethernet	 DeviceNet CANopen	 CC-Link
Cross-section			
Communication	Ethernet CAT5e (1 Gbps)	CANopen® DeviceNet™	CC-Link (10 Mbps)
Coding	A	A	A
Number of cores	8	5	4
Outer sheath, material	PUR	PUR	PVC
Outer sheath, color	Blue (RAL 5021)	Violet	Red
Outer sheath, diameter	6.0 ± 0.3 mm	6.6 ± 0.3 mm	7.0 ± 0.3 mm
Ambient temperature (operation)	-40 °C ~ +80 °C	-40 °C ~ +80 °C	-40 °C ~ +80 °C
Shielding	AL-mylar, tinned copper braided shield	AL-mylar, tinned copper braided shield	AL-Foil, tin-plated copper braided shield
Conductor material	Stranded bare copper	Stranded tinned copper	Stranded bare copper
AWG signal line	26AWG	2 x 22AWG + 2 x 24AWG	1 x 22AWG + 3 x 20AWG
Wire colors	White/Blue, Blue, White/Orange, Orange, White/Green, Green, White/Brown, Brown	24AWG: White, Blue 22AWG: Red, Black	White, Blue, Yellow
Core diameter including insulation	0.92 ± 0.05 mm	24AWG: 1.9 ± 0.05 mm 22AWG: 1.4 ± 0.05 mm	2.2 ± 0.1 mm
Conductor resistance	< 148 Ω/km	22AWG: < 57.4 Ω/km 24AWG: < 91.8 Ω/km	37.8 Ω/km(@20 °C)
Standards / Regulations	ISO/IEC 11801	UL 1581	IEC 61158-2
	UL 1581	UL 758	-
	UL 758	-	-
UL AWM style	20963	21329	-
Flammability test	IEC 60332-1, FT2	IEC 60332-1, FT2	IEC 60332-1

## M12 A-Code Molded Connector ( Shield ) - Networks

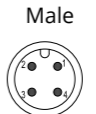
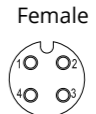
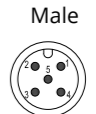
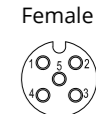
Coding and contacts	Code	A	
	Contact	8	
Rated voltage / current	30V / 2A		
Contact arrangement			
Cable	PUR		
Protocols	Ethernet CAT5e (1Gbps)		
Connector style	Length(m)	Part number	
	2	251-A8000-0ES020	
	5	251-A8000-0ES050	
	10	251-A8000-0ES100	
	2	252-A8000-0ES020	
	5	252-A8000-0ES050	
	10	252-A8000-0ES100	
	2	253-A8000-0ES020	
	5	253-A8000-0ES050	
	10	253-A8000-0ES100	
	2	254-A8000-0ES020	
	5	254-A8000-0ES050	
	10	254-A8000-0ES100	
	0.6	256-A8000-0ESL60	
	1.5	256-A8000-0ES015	
	3	256-A8000-0ES030	
	0.6	257-A8000-0ESL60	
	1.5	257-A8000-0ES015	
	3	257-A8000-0ES030	
<b>Power over Ethernet</b>			
	25	256-A8000-0EP250	
	25	257-A8000-0EP250	

The configuration of connectors and the cable length can be customized. For more details, please contact Dinkle

## M12 A-Code Molded Connector ( Shield ) - Fieldbuses

Coding and contacts	Code	A		A	
	Contact	4		5	
Rated voltage / current	250V / 4A		60V / 4A		
Contact arrangement					
Cable	PVC		PUR		
Protocols	CC-Link		DeviceNet CANopen		
Connector style	Length(m)	Part number			
	2	251-A4000-2CS020		251-A5000-0DS020	
	5	251-A4000-2CS050		251-A5000-0DS050	
	10	251-A4000-2CS100		251-A5000-0DS100	
	2	252-A4000-2CS020		252-A5000-0DS020	
	5	252-A4000-2CS050		252-A5000-0DS050	
	10	252-A4000-2CS100		252-A5000-0DS100	
	2	253-A4000-2CS020		253-A5000-0DS020	
	5	253-A4000-2CS050		253-A5000-0DS050	
	10	253-A4000-2CS100		253-A5000-0DS100	
	2	254-A4000-2CS020		254-A5000-0DS020	
	5	254-A4000-2CS050		254-A5000-0DS050	
	10	254-A4000-2CS100		254-A5000-0DS100	
	0.6	256-A4000-2CSL60		256-A5000-0DSL60	
	1.5	256-A4000-2CS015		256-A5000-0DS015	
	3	256-A4000-2CS030		256-A5000-0DS030	
	0.6	259-A4000-2CSL60		259-A5000-0DSL60	
	1.5	259-A4000-2CS015		259-A5000-0DS015	
	3	259-A4000-2CS030		259-A5000-0DS030	

The configuration of connectors and the cable length can be customized. For more details, please contact Dinkle

## M12 A-Code Device Circular Connector - Industrial Ethernet

### Front mounting with 2m PUR cable

Male

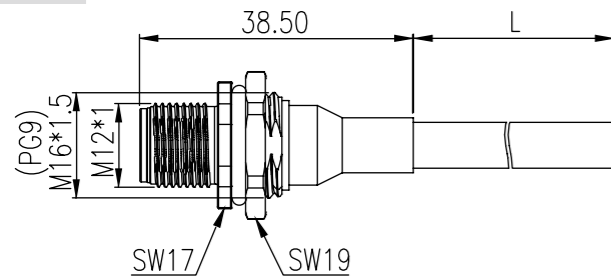

Female

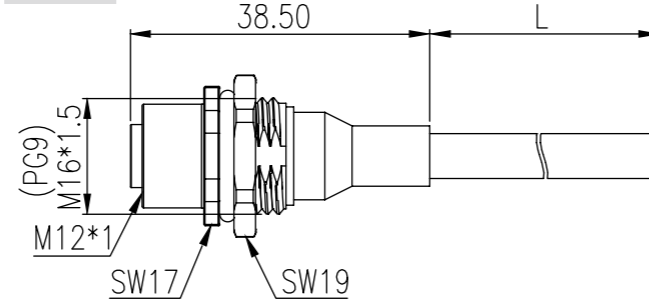

### Rear mounting with 2m PUR cable



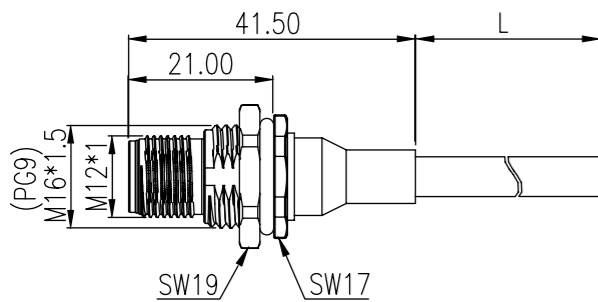

Male

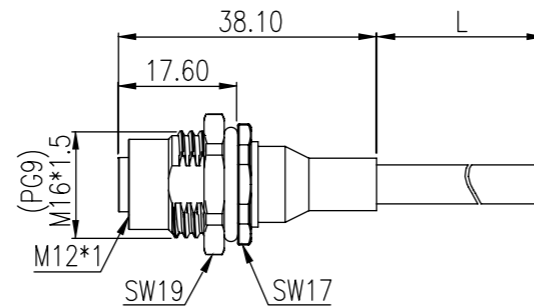





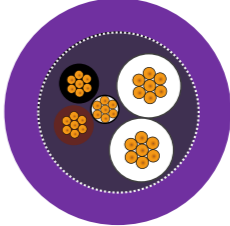
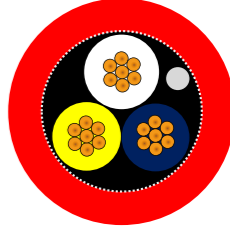

Female



## M12 A-Code Device Connector - Industrial Ethernet

	Ethernet	DeviceNet / CANopen	CC-Link
Protocols	 Ethernet	 DeviceNet CANopen	 CC-Link
Cross-section			
Communication	Ethernet CAT5e (1 Gbps)	CANopen® DeviceNet™	CC-Link (10 Mbps)
Coding	A	A	A
Number of cores	8	5	4
Outer sheath, material	PUR	PUR	PVC
Outer sheath, color	Blue (RAL 5021)	Violet	Red
Outer sheath, diameter	6.0 ± 0.3 mm	6.6 ± 0.3 mm	7.0 ± 0.3 mm
Ambient temperature (operation)	-40 °C ~ +80 °C	-40 °C ~ +80 °C	-40 °C ~ +80 °C
Shielding	AL-mylar, tinned copper braided shield	AL-mylar, tinned copper braided shield	AL-Foil, tin-plated copper braided shield
Conductor material	Stranded bare copper	Stranded tinned copper	Stranded bare copper
AWG signal line	26AWG	2 x 22AWG + 2 x 24AWG	1 x 22AWG + 3 x 20AWG
Wire colors	White/Blue, Blue, White/Orange, Orange, White/Green, Green, White/Brown, Brown	24AWG: White, Blue 22AWG: Red, Black	White, Blue, Yellow
Core diameter including insulation	0.92 ± 0.05 mm	24AWG: 1.9 ± 0.05 mm 22AWG: 1.4 ± 0.05 mm	2.2 ± 0.1 mm
Conductor resistance	< 148 Ω/km	22AWG: < 57.4 Ω/km 24AWG: < 91.8 Ω/km	37.8 Ω/km(@20 °C)
Standards / Regulations	IEC 61076-2-101	IEC 61076-2-101	IEC 61076-2-101
	IEC 60512	IEC 60512	IEC 60512
	IEC 60529	IEC 60529	IEC 60529
UL AWM style	UL 2238	UL 2238	UL 2238
Flammability test	V0	V0	V0

## M12 A-Code Device Connector ( Shield ) - Networks

Coding and contacts	Code	A	
	Contact	8	
Rated voltage / current		30V / 2A	
Contact arrangement	Male	Female	
			
Cable		PUR	
Protocols		Ethernet CAT5e (1Gbps)	
<b>Front mounting with 2m cable</b>			
Connector style	Mount thread	Part number	
 Male	M16 x 1.5	268-A8000-1ES020	
	Pg9	268-A8002-1ES020	
 Female	M16 x 1.5	269-A8000-1ES020	
	Pg9	269-A8002-1ES020	
<b>Rear mounting with 2m cable</b>			
Connector style	Mount thread	Part number	
 Male	M16 x 1.5	270-A8000-1ES020	
	Pg9	270-A8002-1ES020	
 Female	M16 x 1.5	271-A8000-1ES020	
	Pg9	271-A8002-1ES020	

The wire length can be customized. For more details, please contact Dinkle





## M12 A-Code Device Connector ( Shield ) - Fieldbuses

Coding and contacts	Code	A		A	
	Contact	4		5	
Rated voltage / current		250V / 4A		60V / 4A	
Contact arrangement	Male	Female		Male	Female
					
Cable		PVC		PUR	
Protocols		CC-Link		DeviceNet CANopen	
<b>Front mounting with 2m cable</b>					
Connector style		Mount thread	Part number		
 Male		M16 x 1.5	268-A4000-3CS020	268-A5000-1DS020	
		Pg9	268-A4002-3CS020	268-A5002-1DS020	
 Female		M16 x 1.5	269-A4000-3CS020	269-A5000-1DS020	
		Pg9	269-A4002-3CS020	269-A5002-1DS020	
<b>Rear mounting with 2m cable</b>					
Connector style		Mount thread	Part number		
 Male		M16 x 1.5	270-A4000-3CS020	270-A5000-1DS020	
		Pg9	270-A4000-3CS020	270-A5002-1DS020	
 Female		M16 x 1.5	271-A4000-3CS020	271-A5000-1DS020	
		Pg9	271-A4002-3CS020	271-A5002-1DS020	

The wire length can be customized. For more details, please contact Dinkle



## M12 A-Code One-piece PCB Connector ( Shield ) - Networks





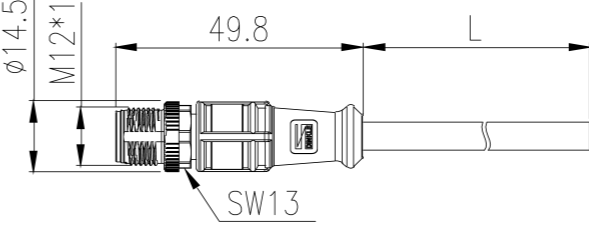
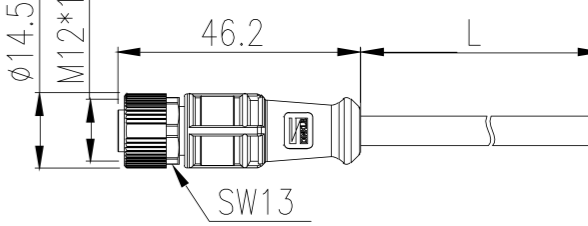
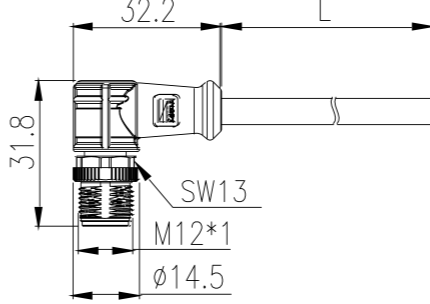
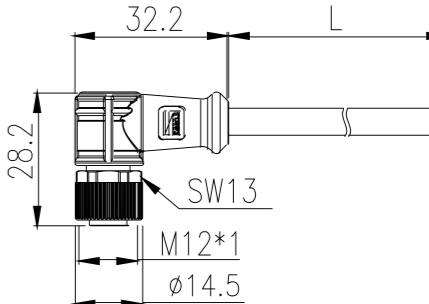

Coding and contacts	Code	A	
	Contact	8	
Rated voltage / current		30V / 2A	
Contact arrangement	Male	Female	
			
Protocols		Ethernet CAT5e	
<b>Rear mounting, straight, Shield</b>			
Connector style	Mount thread	Part number	
	M16 X 1.5	276-A8000-E	
	Pg9	276-A8002-E	
	M16 X 1.5	277-A8000-E	
	Pg9	277-A8002-E	

## M12 B-Code Molded Circular Connector - Industrial Ethernet

<b>Single-ended straight male</b>	<b>Single-ended straight female</b>
	
<b>Single-ended angled male</b>	<b>Single-ended angled female</b>
	

Unit : mm

## M12 A-Code One-piece PCB Connector ( Shield ) - Fieldbuses

Coding and contacts	Code	A		A	
	Contact	4		5	
Rated voltage / current		60V / 4A		60V / 4A	
Rated voltage / current	Male	Female		Male	Female
					
Protocols		CC-Link		DeviceNet/CANopen	
<b>Rear mounting, straight, Shield</b>					
Connector style	Mount thread	Part number		Part number	
	M16 X 1.5	276-A4000-C		276-A5000-D	
	Pg9	276-A4002-C		276-A5002-D	
	M16 X 1.5	277-A4000-C		277-A5000-D	
	Pg9	277-A4002-C		277-A5002-D	

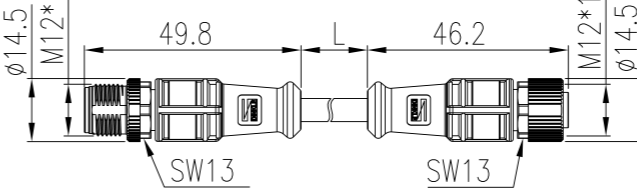
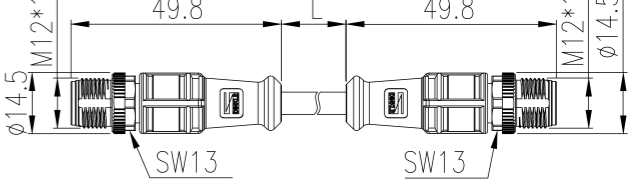
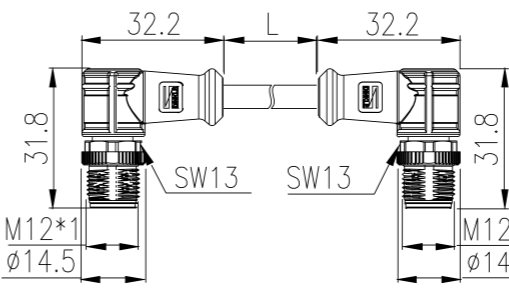
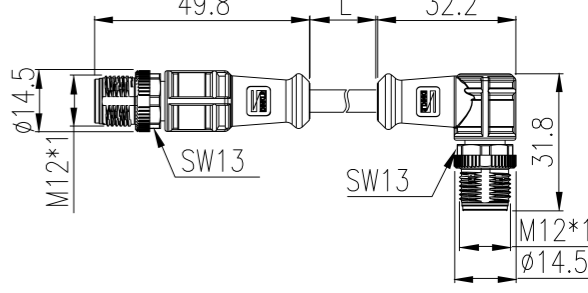

<b>Straight male to straight female</b>	<b>Straight male to straight male</b>
	
<b>Angled male to angled male</b>	<b>Straight male to angled male</b>
	

Unit : mm

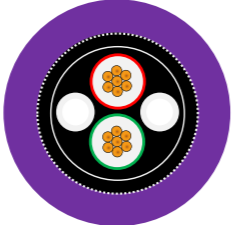
## M12 B-Code Molded Connector - Industrial Ethernet

Protocols	PROFIBUS
	
Cross-section	
Communication	Profibus DP (12 Mbps)
Coding	B
Number of cores	5
Outer sheath, material	PUR
Outer sheath, color	Violet
Outer sheath, diameter	7.8 ± 0.2 mm
"Ambient temperature (operation)"	-40 °C ~ +80 °C
Shielding	AL-mylar, tinned copper braided shield
Conductor material	Stranded tinned copper
AWG signal line	22AWG
Wire colors	Green, Red
Core diameter including insulation	2.7 ± 0.1 mm
Conductor resistance	59.4 Ω/km(@20 °C)
Standards / Regulations	IEC 61158-2
	UL 758
	-
UL AWM style	20233
Flammability test	VW-1

## M12 B-Code Molded Connector ( Shield ) - Fieldbuses

Coding and contacts	Code	B	
	Contact	5	
Rated voltage / current		250V / 4A	
Contact arrangement	Male		Female
			
Cable		PUR	
Protocols		Profibus	
Connector style	Length(m)	Part number	
Single-ended straight male	2	251-B5000-0BS020	
	5	251-B5000-0BS050	
	10	251-B5000-0BS100	
Single-ended straight female	2	252-B5000-0BS020	
	5	252-B5000-0BS050	
	10	252-B5000-0BS100	
Single-ended angled male	2	253-B5000-0BS020	
	5	253-B5000-0BS050	
	10	253-B5000-0BS100	
Single-ended angled female	2	254-B5000-0BS020	
	5	254-B5000-0BS050	
	10	254-B5000-0BS100	
Straight male mate straight female	0.6	256-B5000-0BSL60	
	1.5	256-B5000-0BS015	
	3	256-B5000-0BS030	
Angled male mate angled female	0.6	259-B5000-0BSL60	
	1.5	259-B5000-0BS015	
	3	259-B5000-0BS030	

The configuration of connectors and the cable length can be customized. For more details, please contact Dinkle

## M12 B-Code Device Circular Connector - Industrial Ethernet

### Front mounting with 2m PUR cable

Male

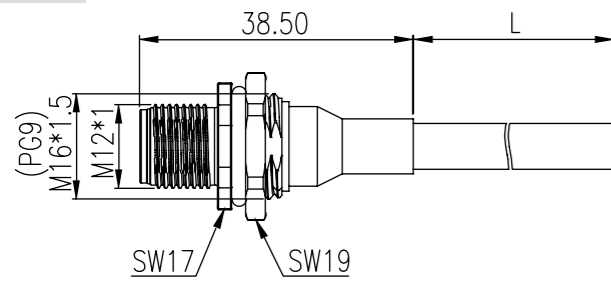

Female

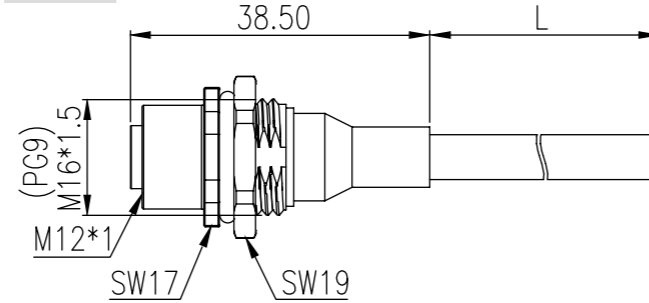

### Rear mounting with 2m PUR cable

Male

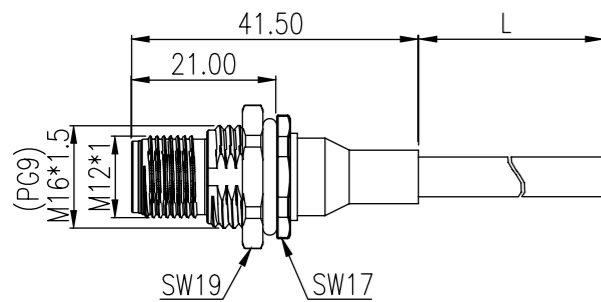

Female

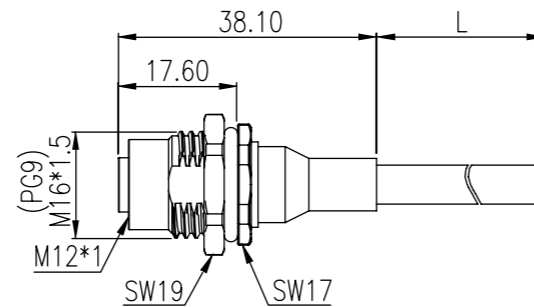

## M12 B-Code Device Connector - Industrial Ethernet

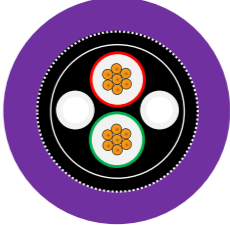



	PROFIBUS
Protocols	
Cross-section	
Communication	Profibus DP (12 Mbps)
Coding	B
Number of cores	5
Outer sheath, material	PUR
Outer sheath, color	Violet
Outer sheath, diameter	7.8 ± 0.2 mm
Ambient temperature (operation)	-40 °C ~ +80 °C
Shielding	AL-mylar, tinned copper braided shield
Conductor material	Stranded tinned copper
AWG signal line	22AWG
Wire colors	Green, Red
Core diameter including insulation	2.7 ± 0.1 mm
Conductor resistance	59.4 Ω/km(@20 °C)
Standards / Regulations	IEC 61158-2
	UL 758
	-
UL AWM style	20233
Flammability test	VW-1



## M12 B-Code One-piece PCB Connector - Industrial Ethernet

Mechanical Properties		Material Properties	
Min. Insertion/withdrawal cycles	100	Contact / contact surface	Copper alloy / Gold plated
Degree of protection	IP67	Contact carrier	PA
Operating Temperature	-40°C ~ 80°C	Hexigonal nut / Outer Shield	Zinc die-cast, nickel-plated / Brass, nickel-plated
Fasten torque	0.4 Nm	O-ring	NBR
Soldering method	Wave Soldering	UL94 Flammability rating	V0
Electrical Properties		Cable Information	
Rated voltage / current (contacts)	60VAC / 4A (5 Pin)		
Rated Impulse Voltage	1.5kV (5 Pin)		
Insulation resistance	Min. 100MΩ		
Overtoltage Category	II		
Pollution Degree	3		
Standards and Regulations			
Design reference	IEC 61076-2-101: Detail specification for M12 connectors with screw-locking IEC 61076-2-111: Circular connectors - Detail specification for power connectors with M12 screw-locking IEC 60512: Electromechanical components for electronic equipment; basic testing procedure and measuring methods IEC 60529: Degree of protection provided by enclosures (IP Code)		
Certification reference	UL 2238 / UL2237		
Notice			
The mechanical and electrical data performance can be ensured when the connector pair is correctly locked and fasten by specified torque. If the connector is not locked and or exposed in th contaminated enviroment, the connector must be sealed by the protective cover. Also, the influences from conductor, cable or PCB assembly must be taken into consideration.			

## M12 B-Code One-piece PCB Connector ( Shield ) - Fieldbuses

Coding and contacts	Code	B	
	Contact	5	
Rated voltage / current		30V / 2A	
Contact arrangement		Male 	Female 
Protocols		Profibus	
Rear mounting, straight, Shield			
Connector style	Mount thread	Part number	
Male 	M16 X 1.5	276-B5000-B	
	Pg9	276-B5002-B	
Female 	M16 X 1.5	277-B5000-B	
	Pg9	277-B5002-B	

## M12 D-Code Molded Circular Connector - Industrial Ethernet

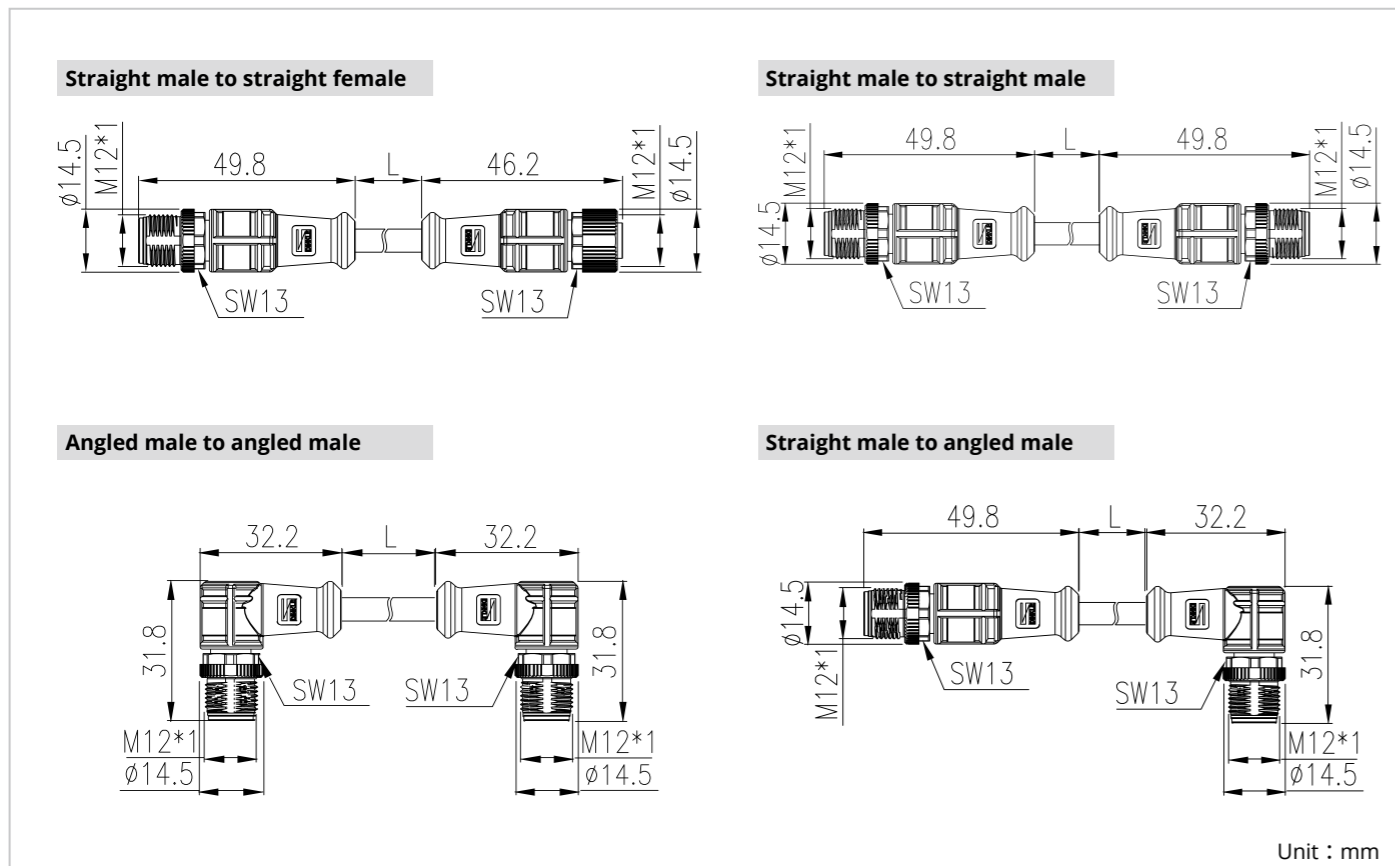
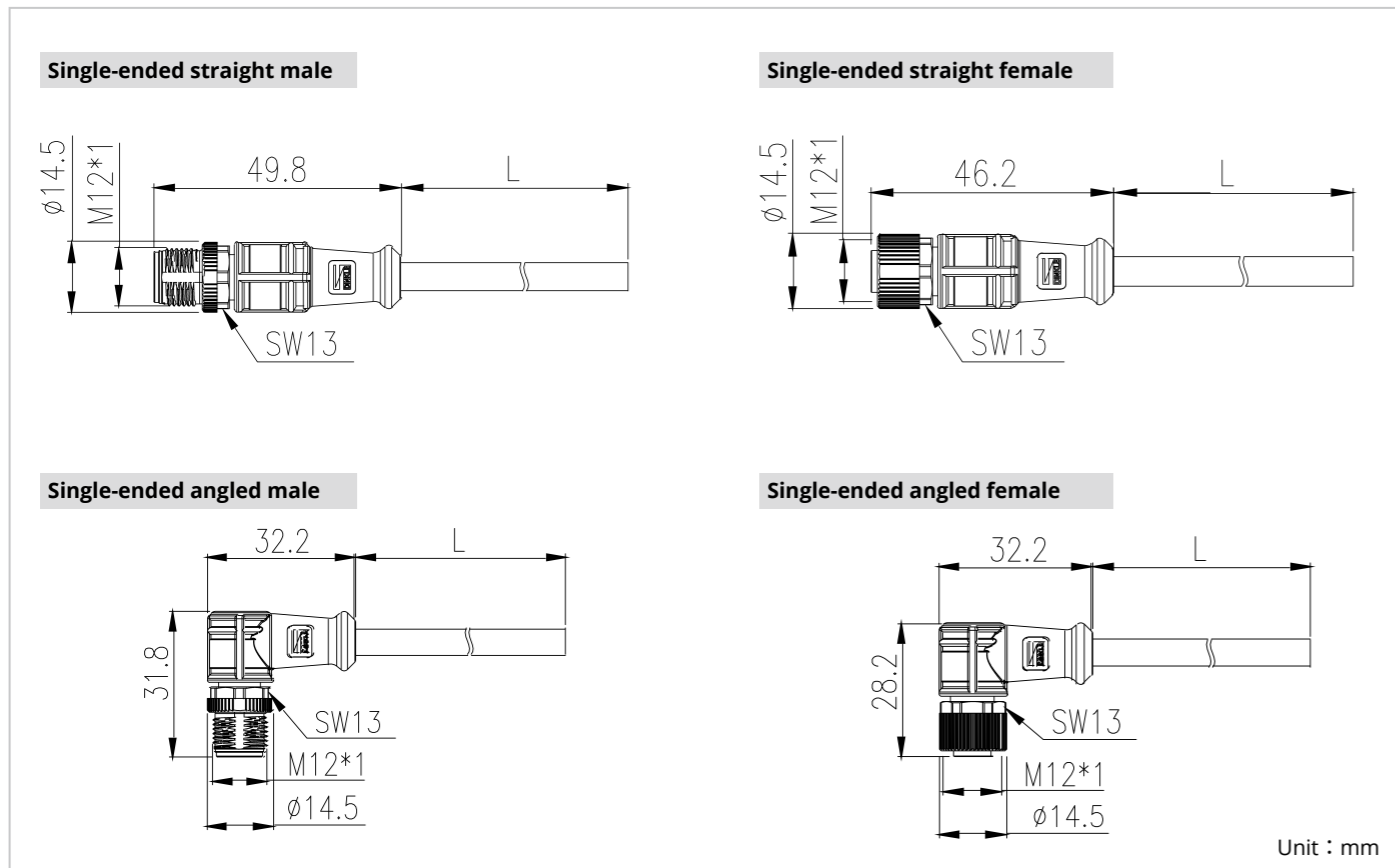

## M12 D-Code Molded Connector - Industrial Ethernet

	Profinet	Ethernet
Protocols	 <b>PROFI NET</b>	 <b>Ethernet</b>
Cross-section		
Communication	PROFINET (100 Mbps)	Ethernet CAT5 (100 Mbps)
Coding	D	D
Number of cores	4	4
Outer sheath, material	PVC	PUR
Outer sheath, color	Green (RAL 6008)	Blue (RAL 5021)
Outer sheath, diameter	6.5 ± 0.2 mm	6.0 ± 0.25 mm
Ambient temperature (operation)	-40 °C ~ +80 °C	-40 °C ~ +80 °C
Shielding	AL-Foil, tin-plated copper braided shield	AL-mylar, tinned copper braided shield
Conductor material	Stranded tinned copper	Stranded bare copper
AWG signal line	22 AWG	26 AWG
Wire colors	White, Yellow, Blue, Orange	White/Orange, Orange, White/Green, Green
Core diameter including insulation	1.5 ± 0.1 mm	0.9 ± 0.05 mm
Conductor resistance	59.4 Ω / km (@20 °C)	< 148 Ω / km
Standards / Regulations	IEC 61156-6	ISO / IEC 11801
	ISO / IEC 11801	UL 1581
	UL 758	UL 758
UL AWM style	21694	20963
Flammability test	IEC 60332-1, FT2	IEC 60332-1, FT2

## M12 D-Code Molded Connector ( Shield ) - Networks

Coding and contacts	Code	D		D	
	Contact	4		4	
Rated voltage / current		250V / 4A		30V / 2A	
Contact arrangement		Male 	Female 	Male 	Female 
Cable		PVC		PUR	
Protocols		Profinet (100Mbps)		Ethernet CAT5 (100Mbps)	
Connector style	Length(m)	Part number			
Single-ended straight male 	2	251-D4000-2PS020	251-D4000-0ES020		
	5	251-D4000-2PS050	251-D4000-0ES050		
	10	251-D4000-2PS100	251-D4000-0ES100		
Single-ended straight female 	2	252-D4000-2PS020	252-D4000-0ES020		
	5	252-D4000-2PS050	252-D4000-0ES050		
	10	252-D4000-2PS100	252-D4000-0ES100		
Single-ended angled male 	2	253-D4000-2PS020	253-D4000-0ES020		
	5	253-D4000-2PS050	253-D4000-0ES050		
	10	253-D4000-2PS100	253-D4000-0ES100		
Single-ended angled female 	2	254-D4000-2PS020	254-D4000-0ES020		
	5	254-D4000-2PS050	254-D4000-0ES050		
	10	254-D4000-2PS100	254-D4000-0ES100		
Straight male mate straight female 	0.6	256-D4000-2PSL60	256-D4000-0ESL60		
	1.5	256-D4000-2PS015	256-D4000-0ES015		
	3	256-D4000-2PS030	256-D4000-0ES030		
Straight male mate straight male 	0.6	257-D4000-2PSL60	257-D4000-0ESL60		
	1.5	257-D4000-2PS015	257-D4000-0ES015		
	3	257-D4000-2PS030	257-D4000-0ES030		
Power over Ethernet					
Straight male mate straight female 	25	256-D4000-2PP250	256-D4000-0EP250		
Straight male mate straight male 	25	257-D4000-2PP250	257-D4000-0EP250		

The configuration of connectors and the cable length can be customized. For more details, please contact Dinkle

## M12 D-Code Device Circular Connector - Industrial Ethernet

### Front mounting with 2m PUR cable

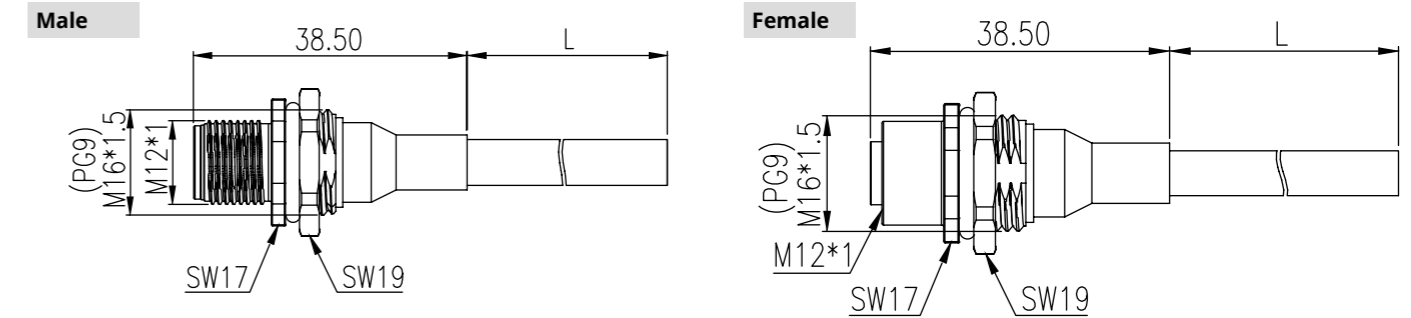



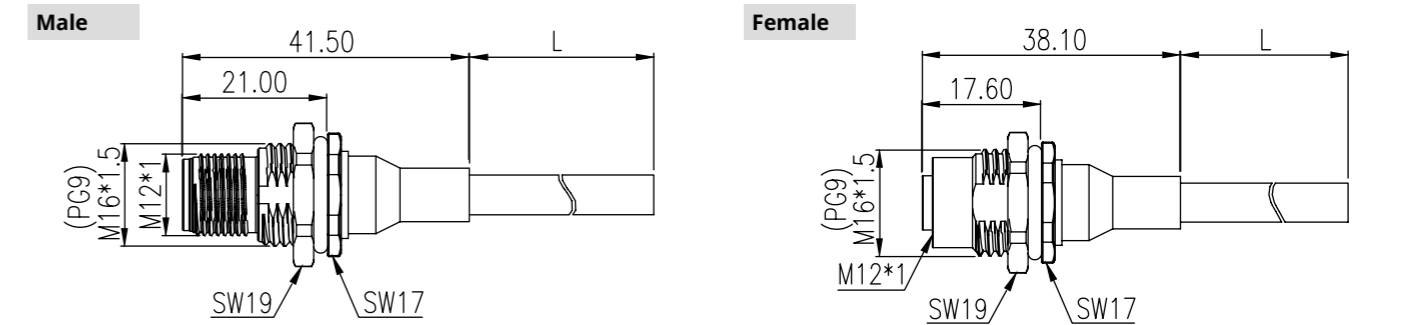









### Rear mounting with 2m PUR cable



## M12 D-Code Device Connector - Industrial Ethernet

	Profinet	Ethernet
Protocols		
Cross-section		
Communication	Profinet (100 Mbps)	Ethernet CAT5 (100 Mbps)
Coding	D	D
Number of cores	4	4
Outer sheath, material	PVC	PUR
Outer sheath, color	Green (RAL 6008)	Blue (RAL 5021)
Outer sheath, diameter	6.5 ± 0.2 mm	6.0 ± 0.3 mm
Ambient temperature (operation)	-40 °C ~ +80 °C	-40 °C ~ +80 °C
Shielding	AL-Foil, tin-plated copper braided shield	AL-mylar, tinned copper braided shield
Conductor material	Stranded tinned copper	Stranded bare copper
AWG signal line	22AWG	26AWG
Wire colors	White, Yellow, Blue, Orange	White/Orange, Orange, White/Green, Green
Core diameter including insulation	1.5 ± 0.1 mm	0.9 ± 0.05 mm
Conductor resistance	59.4 Ω/km(@20 °C)	< 148 Ω/km
Standards / Regulations	IEC 61156-6	ISO/IEC 11801
	ISO/IEC 11801	UL 1581
	UL 758	UL 758
UL AWM style	21694	20963
Flammability test	IEC 60332-1, FT2	IEC 60332-1, FT2

## M12 D-Code Device Connector ( Shield ) - Networks

Coding and contacts	Code	D		D	
	Contact	4		4	
Rated voltage / current		250V / 4A		30V / 4A	
Contact arrangement		Male 	Female 	Male 	Female 
Cable		PVC		PUR	
Protocols		Profinet (100Mbps)		Ethernet CAT5 (100Mbps)	
<b>Front mounting with 2m cable</b>					
Connector style		Mount thread	Part number		
Male 		M16 x 1.5	268-D4000-3PS020	268-D4000-1ES020	
		Pg9	268-D4002-3PS020	268-D4002-1ES020	
Female 		M16 x 1.5	269-D4000-3PS020	269-D4000-1ES020	
		Pg9	269-D4002-3PS020	269-D4002-1ES020	
<b>Rear mounting with 2m cable</b>					
Connector style		Mount thread	Part number		
Male 		M16 x 1.5	270-D4000-3PS020	270-D4000-1ES020	
		Pg9	270-D4002-3PS020	270-D4002-1ES020	
Female 		M16 x 1.5	271-D4000-3PS020	271-D4000-1ES020	
		Pg9	271-D4002-3PS020	271-D4002-1ES020	

The wire length can be customized. For more details, please contact Dinkle

## M12 D-Code One-piece PCB Circular Connector - Industrial Ethernet

### 180° Rear mounting, straight (Shielded)

#### Male

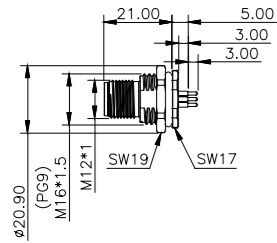

#### Female

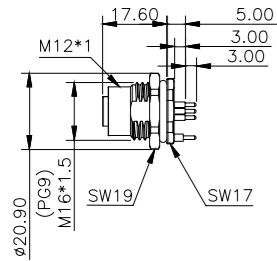

PCB Layout	
Pin out	
Pin arrangement	
	4P D- code
PCB Layout	
Pin out	
Pin arrangement	
	4P D- code

## M12 D-Code One-piece PCB Connector - Industrial Ethernet

Mechanical Properties		Material Properties	
Min. Insertion/withdrawal cycles	100	Contact / contact surface	Copper alloy / Gold plated
Degree of protection	IP67	Contact carrier	PA
Operating Temperature	-40°C ~ 80°C	Hexagonal nut / Outer Shield	Zinc die-cast, nickel-plated / Brass, nickel-plated
Fasten torque	0.4 Nm	O-ring	NBR
Soldering method	Wave Soldering	UL94 Flammability rating	V0

Electrical Properties		Cable Information	
Rated voltage / current (contacts)	250VAC / 4A (≤4 Pin)		
Rated Impulse Voltage	2.5kV (≤4 Pin)		
Insulation resistance	Min. 100MΩ		
Overvoltage Category	II		
Pollution Degree	3		

### Standards and Regulations

Design reference	IEC 61076-2-101: Detail specification for M12 connectors with screw-locking IEC 61076-2-111: Circular connectors - Detail specification for power connectors with M12 screw-locking IEC 60512: Electromechanical components for electronic equipment; basic testing procedure and measuring methods IEC 60529: Degree of protection provided by enclosures (IP Code)
Certification reference	UL 2238 / UL2237

### Notice

The mechanical and electrical data performance can be ensured when the connector pair is correctly locked and fasten by specified torque. If the connector is not locked and or exposed in th contaminated enviroment, the connector must be sealed by the protective cover. Also, the influences from conductor, cable or PCB assembly must be taken into consideration.

## M12 D-Code One-piece PCB Connector ( Shield ) - Networks

Coding and contacts	Code	D		D	
	Contact	4		4	
Rated voltage / current		60V / 4A		60V / 4A	
Contact arrangement		Male 	Female 	Male 	Female 
Protocols		PROFINET		Ethernet CAT5e	
Rear mounting, straight, Shield					
Connector style	Mount thread	Part number			
 Male	M16 X 1.5	276-D4000-P		276-D4000-E	
	Pg9	276-D4002-P		276-D4002-E	
 Female	M16 X 1.5	277-D4000-P		277-D4000-E	
	Pg9	277-D4002-P		277-D4002-E	

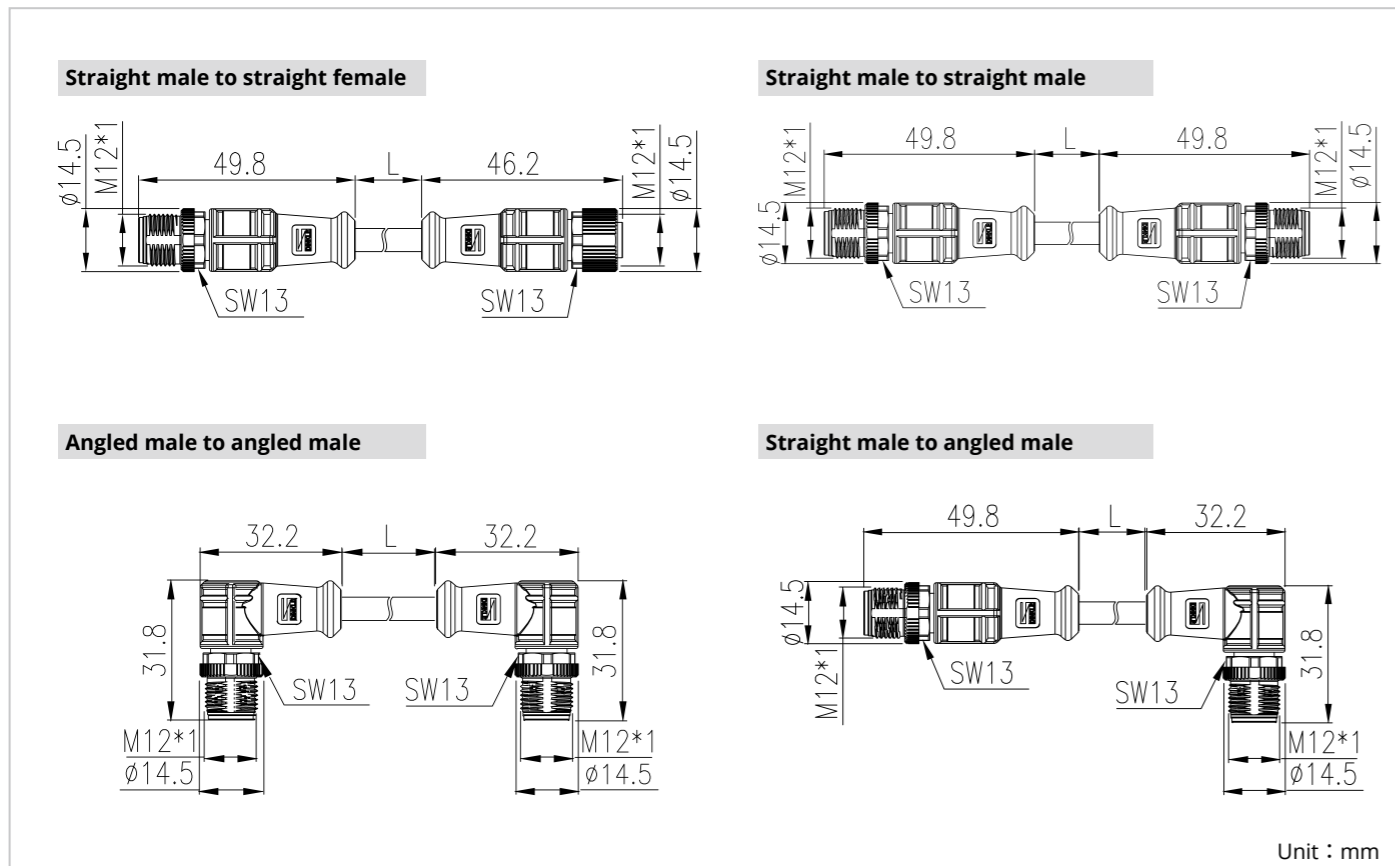
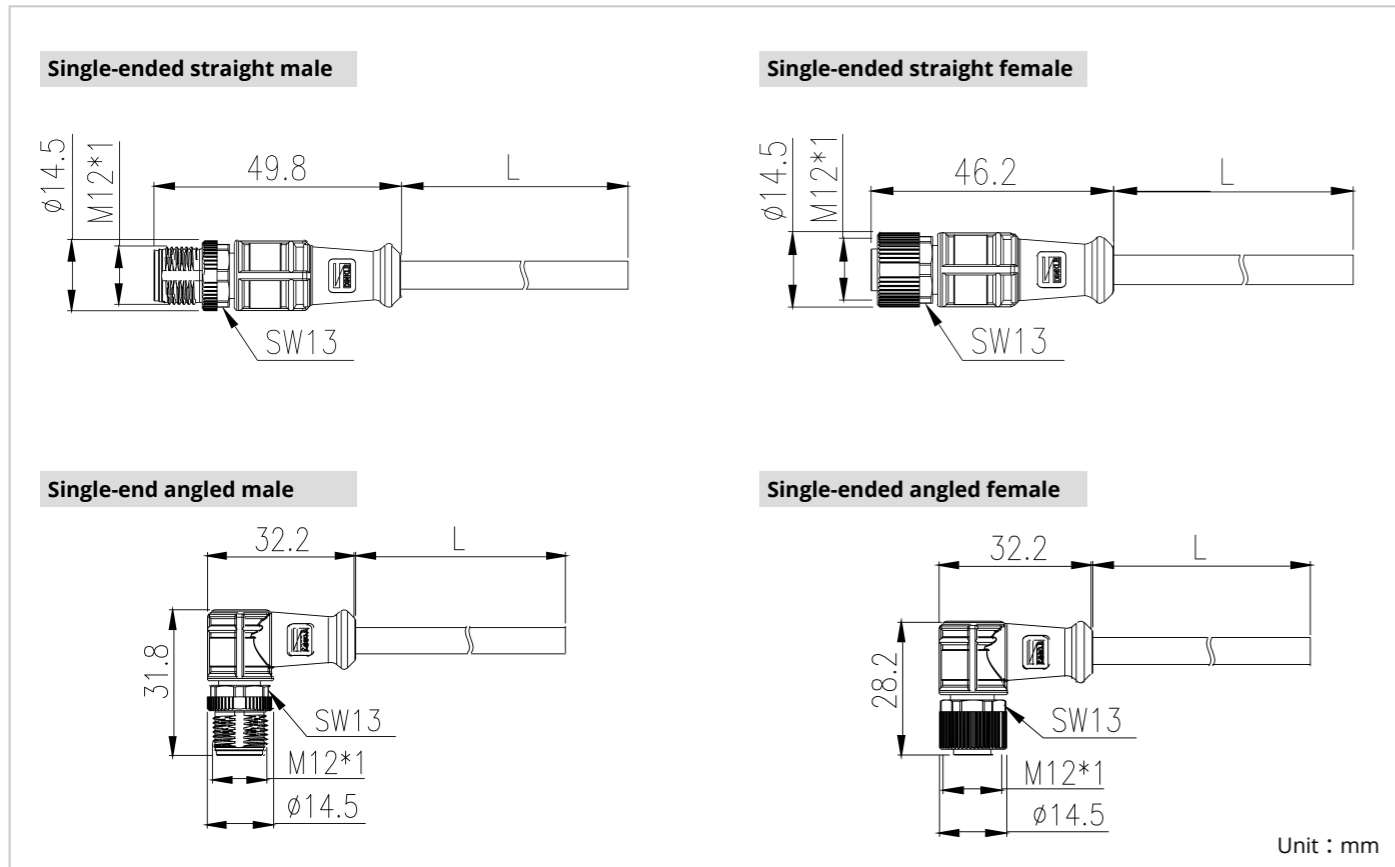

## M12 X-Code Molded Circular Connector - Industrial Ethernet



## M12 X-Code Molded Connector - Industrial Ethernet

Protocols	Ethernet
	
Cross-section	
Communication	Ethernet CAT6A (10 Gbps)
Coding	X
Number of cores	8
Outer sheath, material	PUR
Outer sheath, color	Blue (RAL 5021)
Outer sheath, diameter	6.45± 0.2 mm
Ambient temperature (operation)	-40 °C ~ +80 °C
Shielding	AL-mylar, tinned copper braided shield
Conductor material	Stranded bare copper
AWG signal line	26AWG
Wire colors	White/Orange, Orange, White/Green, Green, White/Brown, Brown, White/Blue, Blue
Core diameter including insulation	1.08 ± 0.2 mm
Conductor resistance	148 Ω/km
Standards / Regulations	ISO/IEC 11801 EIA/TIA 568 IEC 60754-1
UL AWM style	20549
Flammability test	IEC 60332-1, FT2



## M12 X-Code Molded Connector ( Shield ) - Networks

Coding and contacts	Code	X
	Contact	8
Rated voltage / current	50V / 0.5A	
Contact arrangement	Male	
	Cable	PUR
Protocols	Ethernet CAT6A (10Gbps)	
Connector style	Length(m)	Part number
Single-ended straight male 	2	251-X8300-0AS020
	5	251-X8300-0AS050
	10	251-X8300-0AS100

The configuration of connectors and the cable length can be customized. For more details, please contact Dinkle

## M12 X-Code One-piece PCB Circular Connector - Industrial Ethernet

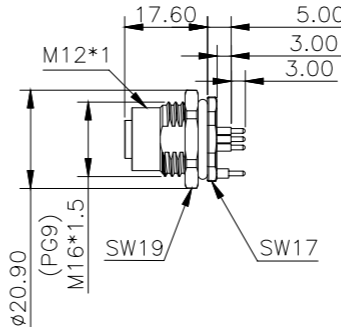
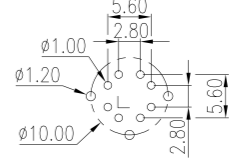

### 180° Rear mounting, straight (Shielded)

Female 	PCB Layout	
	Pin out	
Pin arrangement	8P X-code	

## M12 X-Code One-piece PCB Circular Connector - Industrial Ethernet

Mechanical Properties		Material Properties	
Min. Insertion/withdrawal cycles	100	Contact / contact surface	Copper alloy / Gold plated
Degree of protection	IP67	Contact carrier	PA
Operating Temperature	-40°C ~ 80°C	Hexagonal nut / Outer Shield	Zinc die-cast, nickel-plated / Brass, nickel-plated
Fasten torque	0.4 Nm	O-ring	NBR
Soldering method	Wave Soldering	UL94 Flammability rating	V0
Electrical Properties		Cable Information	
Rated voltage / current (contacts)	30VAC / 2A (8 Pin)		
Rated Impulse Voltage	0.8kV (8 Pin)		
Insulation resistance	Min. 100MΩ		
Overvoltage Category	II		
Pollution Degree	3		
Standards and Regulations			
Design reference	IEC 61076-2-101: Detail specification for M12 connectors with screw-locking IEC 61076-2-111: Circular connectors - Detail specification for power connectors with M12 screw-locking IEC 60512: Electromechanical components for electronic equipment; basic testing procedure and measuring methods IEC 60529: Degree of protection provided by enclosures (IP Code)		
Certification reference	UL 2238 / UL2237		
Notice			
The mechanical and electrical data performance can be ensured when the connector pair is correctly locked and fasten by specified torque. If the connector is not locked and or exposed in th contaminated enviroment, the connector must be sealed by the protective cover. Also, the influences from conductor, cable or PCB assembly must be taken into consideration.			

## M12 X-Code One-piece PCB Connector ( Shield ) - Networks

Coding and contacts	Code	X
	Contact	8
Rated voltage / current		30V / 1.5A
Contact arrangement		Female 
Protocols		Ethernet CAT6A
<b>Rear mounting, straight, Shield</b>		
Connector style	Mount thread	Part number
Male 	M16 X 1.5	-
	Pg9	-
Female 	M16 X 1.5	277-X8300-3
	Pg9	277-X8302-3

# Functional class

Dinkle provides high-quality M8 and M12 circular connector mate RJ45 adapter solutions designed specifically for the demanding network communication needs of industrial automation and harsh environments. These circular connectors securely encapsulate the RJ45 network interface in an IP67-rated metal housing, offering waterproof and dustproof protection while maintaining stable data transmission even in conditions with moisture, oil, and dust.

With excellent vibration resistance and durability, these connectors are particularly suited for applications such as factory automation equipment, robotic arms, and intelligent warehousing systems, ensuring stable and reliable Ethernet connections. Dinkle's circular connector mate RJ45 series is easy to install and maintain, effectively reducing wiring errors during network installation, enhancing overall production efficiency, and providing dependable network connection protection for your equipment.





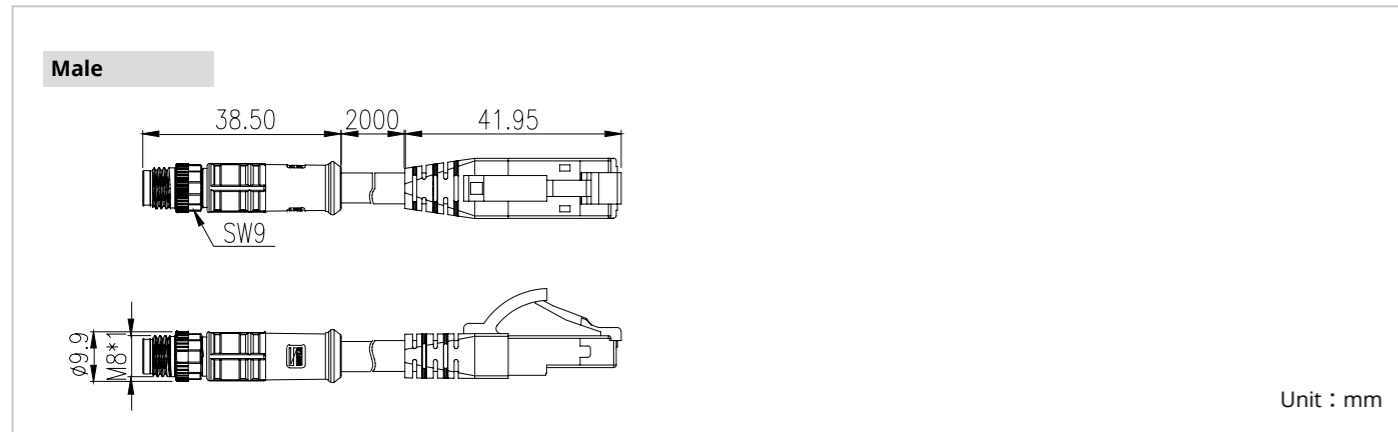



## M8 A-Code Molded Circular Connector Mate RJ45 Connector



## M8 A-Code Molded Connector Mate RJ45 Connector

Protocols	Profinet
	Ethernet
Cross-section	
Communication	Ethernet CAT5e
Coding	A
Number of cores	4
Outer sheath, material	PUR
Outer sheath, color	Blue (RAL 5021)
Outer sheath, diameter	6.0 ± 0.2 mm
Ambient temperature (operation)	-40 °C ~ +80 °C
Shielding	AL-Foil, tin-plated copper braided shield
Conductor material	Stranded tinned copper
AWG signal line	26AWG
Wire colors	White/Orange, Orange, White/Green, Green
Core diameter including insulation	0.9 ± 0.05 mm
Conductor resistance	< 148 Ω/km
Standards / Regulations	ISO / IEC 11801
	UL 1581
	UL 758
UL AWM style	20963
Flammability test	IEC 60332-1, FT2

## M8 A-Code Molded Connector Mate RJ45 Connector

<b>Coding and contacts</b>	<b>Code</b>	<b>A</b>	
	<b>Contact</b>	<b>8</b>	
<b>Rated voltage / current</b>		30V / 2A	
<b>Contact arrangement</b>		Male 	Female 
<b>Cable</b>		PUR	
<b>Protocols</b>		Ethernet CAT5e (1Gbps)	
<b>Connector style</b>	<b>Length(m)</b>	<b>Part number</b>	
Straight male mate RJ45 	0.6	399-A4EML60	
	1.5	399-A4EM015	
	3	399-A4EM030	
Straight female mate RJ45 	0.6	399-A4EFL60	
	1.5	399-A4EF015	
	3	399-A4EF030	
Angled male mate RJ45 	0.6	398-A4EML60	
	1.5	398-A4EM015	
	3	398-A4EM030	
Angled female mate RJ45 	0.6	398-A4EFL60	
	1.5	398-A4EF015	
	3	398-A4EF030	

The configuration of connectors and the cable length can be customized. For more details, please contact Dinkle

## M12 A-Code Molded Circular Connector Mate RJ45 Connector

**Straight male mate RJ45 (Shielded)**

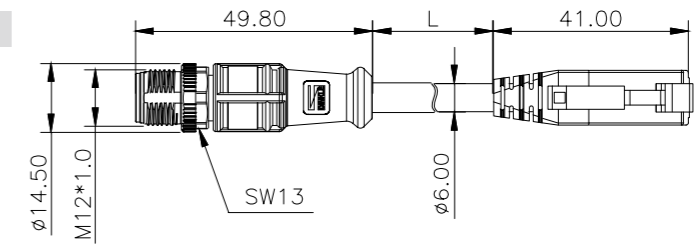

**Straight female mate RJ45 (Shielded)**

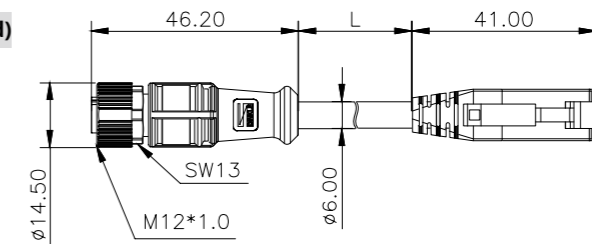

**Angled male mate RJ45 (Shielded)**

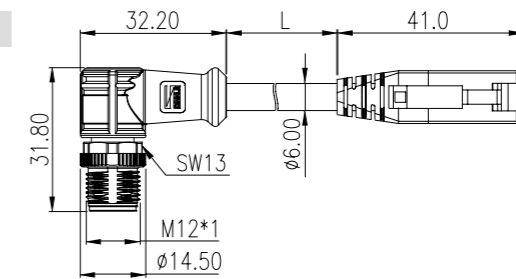

**Angled female mate RJ45 (Shielded)**

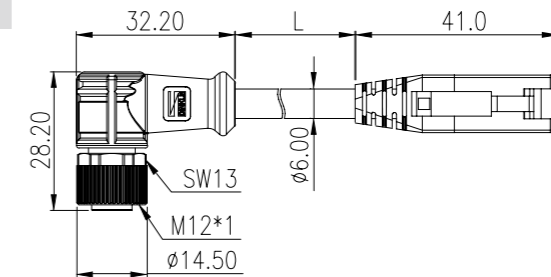

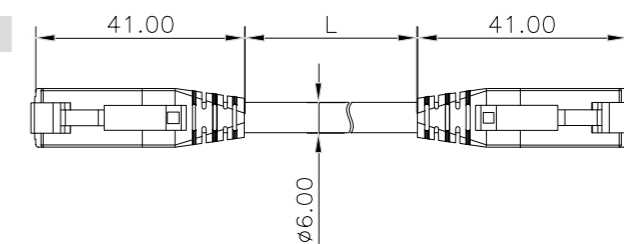

**RJ45+RJ45**









Unit : mm

## M12 A-Code Molded Connector Mate RJ45 Connector

Protocols	Ethernet
	 <p style="text-align: center;"><b>Ethernet</b></p>
Cross-section	
Communication	Ethernet CAT5e (1 Gbps)
Coding	A
Number of cores	8
Outer sheath, material	PUR
Outer sheath, color	Blue (RAL 5021)
Outer sheath, diameter	6.0 ± 0.3 mm
Ambient temperature (operation)	-40 °C ~ +80 °C
Shielding	AL-mylar, tinned copper braided shield
Conductor material	Stranded bare copper
AWG signal line	26AWG
Wire colors	White/Blue, Blue, White/Orange, Orange, White/Green, Green, White/Brown, Brown
Core diameter including insulation	0.92 ± 0.05 mm
Conductor resistance	< 148 Ω/km
Standards / Regulations	ISO/IEC 11801
	UL 1581
	UL 758
UL AWM style	20963
Flammability test	IEC 60332-1, FT2

## M12 A-Code Molded Connector Mate RJ45 Connector ( Shield ) - Networks

Coding and contacts	Code	A	
	Contact	8	
Rated voltage / current		30V / 1A	
Contact arrangement	Male		Female
			
Cable		PUR	
Protocols		Ethernet CAT5e (1Gbps)	
Connector style	Length(m)	Part number	
Straight male mate RJ45 	0.6	299-A8EML60	
	1.5	299-A8EM015	
	3	299-A8EM030	
Straight female mate RJ45 	0.6	299-A8EFL60	
	1.5	299-A8EF015	
	3	299-A8EF030	
Angled male mate RJ45 	0.6	298-A8EML60	
	1.5	298-A8EM015	
	3	298-A8EM030	
Angled female mate RJ45 	0.6	298-A8EFL60	
	1.5	298-A8EF015	
	3	298-A8EF030	
RJ45 + RJ45 	1	0206-0301	
	3	0206-0303	
	5	0206-0305	

The configuration of connectors and the cable length can be customized. For more details, please contact Dinkle

## M12 A-Code Device Circular Connector Mate RJ45 Connector

### Rear mounting male mate RJ45 (Shielded)

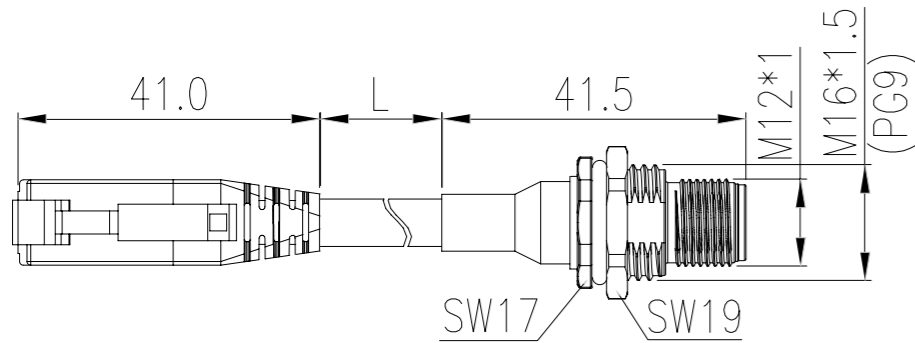

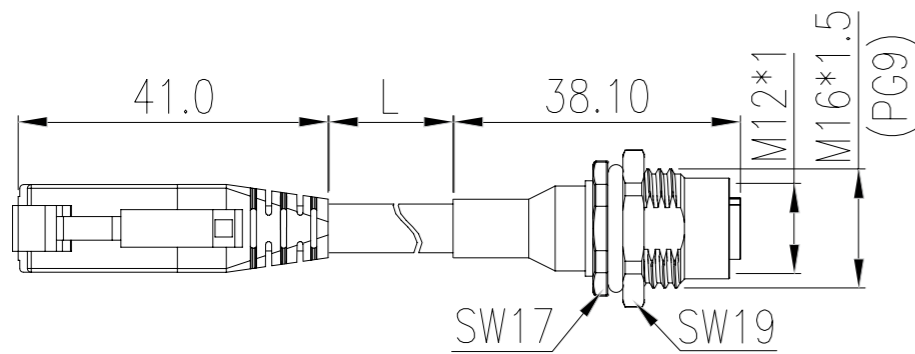

### Rear mounting female mate RJ45 (Shielded)







Unit : mm

## M12 A-Code Device Connector Mate RJ45 Connector

Protocols	Ethernet 
Cross-section	Ethernet 
Communication	Ethernet CAT5e (1 Gbps)
Coding	A
Number of cores	8
Outer sheath, material	PUR
Outer sheath, color	Blue (RAL 5021)
Outer sheath, diameter	6.0 ± 0.3 mm
Ambient temperature (operation)	-40 °C ~ +80 °C
Shielding	AL-mylar, tinned copper braided shield
Conductor material	Stranded bare copper
AWG signal line	26AWG
Wire colors	White/Blue, Blue, White/Orange, Orange, White/Green, Green, White/Brown, Brown
Core diameter including insulation	0.92 ± 0.05 mm
Conductor resistance	< 148 Ω/km
Standards / Regulations	IEC 61076-2-101
	IEC 60512
	IEC 60529
UL AWM style	UL 2238
Flammability test	V0

## M12 A-Code Device Connector Mate RJ45 Connector ( Shield ) - Networks

Coding and contacts	Code	<b>A</b>	
	Contact	<b>8</b>	
Rated voltage / current		30V / 2A	
Contact arrangement		Male 	Female 
Cable		PUR	
Protocols		Ethernet CAT5e (1Gbps)	
<b>Rear mounting mate RJ45 with 2m cable</b>			
Connector style	Mount thread	Part number	
Male 	M16 x 1.5	0206-700-0302	
	Pg9	0206-702-0302	
Female 	M16 x 1.5	0206-710-0302	
	Pg9	0206-712-0302	

The wire length can be customized. For more details, please contact Dinkle

## M12 D-Code Molded Circular Connector Mate RJ45 Connector

**Straight male mate RJ45 (Shielded)**

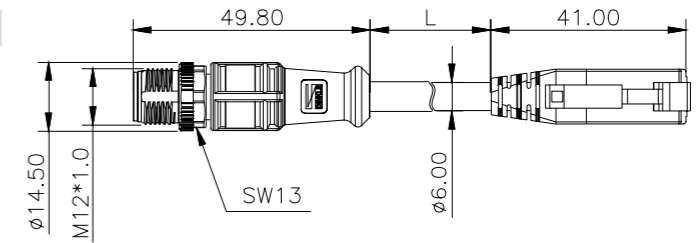

**Straight female mate RJ45 (Shielded)**

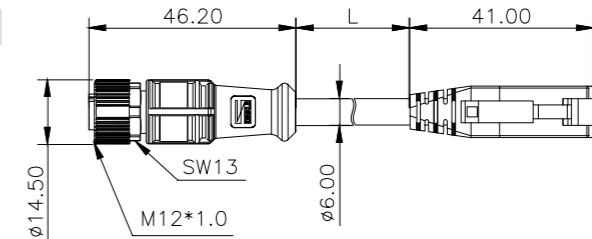

**Angled male mate RJ45 (Shielded)**

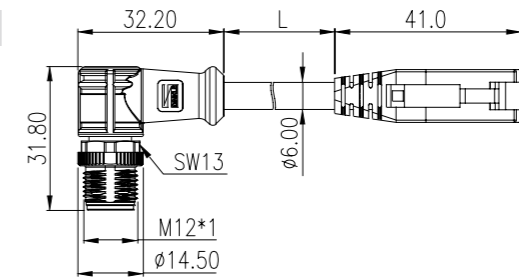

**Angled female mate RJ45 (shielded)**

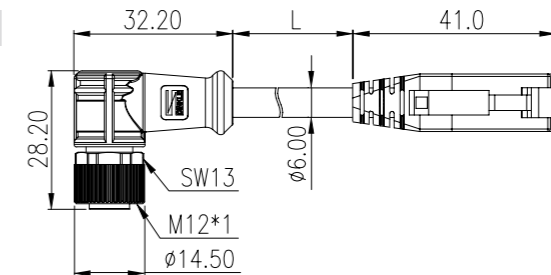

**RJ45+RJ45**

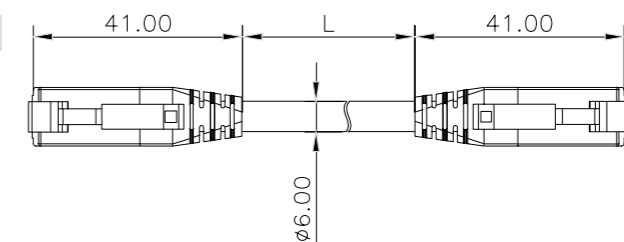









Unit : mm

## M12 D-Code Molded Connector Mate RJ45 Connector

	Profinet	Ethernet
Protocols		
Cross-section		
Communication	Profinet (100 Mbps)	Ethernet CAT5 (100 Mbps)
Coding	D	D
Number of cores	4	4
Outer sheath, material	PVC	PUR
Outer sheath, color	Green (RAL 6008)	Blue (RAL 5021)
Outer sheath, diameter	6.5 ± 0.2 mm	6.0 ± 0.3 mm
Ambient temperature (operation)	-40 °C ~ +80 °C	-40 °C ~ +80 °C
Shielding	AL-Foil, tin-plated copper braided shield	AL-mylar, tinned copper braided shield
Conductor material	Stranded tinned copper	Stranded bare copper
AWG signal line	22AWG	26AWG
Wire colors	White, Yellow, Blue, Orange	White/Orange, Orange, White/Green, Green
Core diameter including insulation	1.5 ± 0.1 mm	0.9 ± 0.05 mm
Conductor resistance	59.4 Ω/km(@20 °C)	< 148 Ω/km
Standards / Regulations	IEC 61156-6	ISO/IEC 11801
	ISO/IEC 11801	UL 1581
	UL 758	UL 758
UL AWM style	21694	20963
Flammability test	IEC 60332-1, FT2	IEC 60332-1, FT2

## M12 D-Code Molded Connector Mate RJ45 Connector ( Shield ) - Networks

Coding and contacts	Code	D		D	
	Contact	4		4	
Rated voltage / current		250V / 4A		30V / 2A	
Contact arrangement	Male		Female	Male	Female
					
Cable		PVC		PUR	
Protocols		Profinet (100Mbps)		Ethernet CAT5 (100Mbps)	
Connector style	Length(m)	Part number			
Straight male mate RJ45 	0.6	299-D4PML60		299-D4EML60	
	1.5	299-D4PM015		299-D4EM015	
	3	299-D4PM030		299-D4EM030	
Straight female mate RJ45 	0.6	299-D4PFL60		299-D4EFL60	
	1.5	299-D4PF015		299-D4EF015	
	3	299-D4PF030		299-D4EF030	
Angled male mate RJ45 	0.6	298-D4PML60		298-D4EML60	
	1.5	298-D4PM015		298-D4EM015	
	3	298-D4PM030		298-D4EM030	
Angled female mate RJ45 	0.6	298-D4PFL60		298-D4EFL60	
	1.5	298-D4PF015		298-D4EF015	
	3	298-D4PF030		298-D4EF030	
RJ45 + RJ45 	1	0206-0101		0206-0201	
	3	0206-0103		0206-0203	
	5	0206-0105		0206-0205	

The configuration of connectors and the cable length can be customized. For more details, please contact Dinkle

## M12 D-Code Device Circular Connector Mate RJ45 Connector

Rear mounting male mate RJ45 (Shielded)

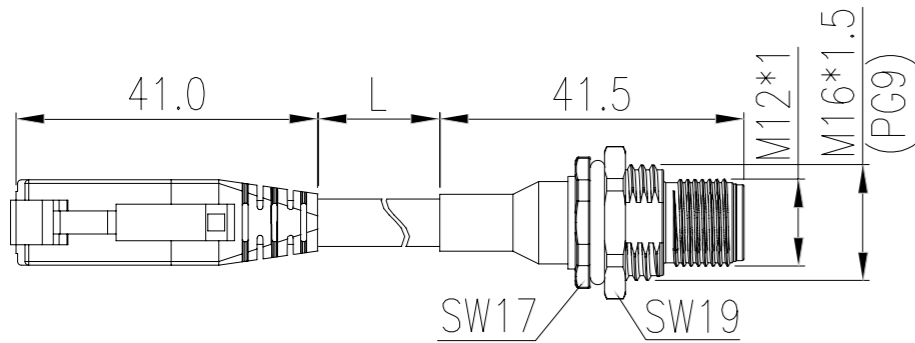

Rear mounting female mate RJ45 (Shielded)

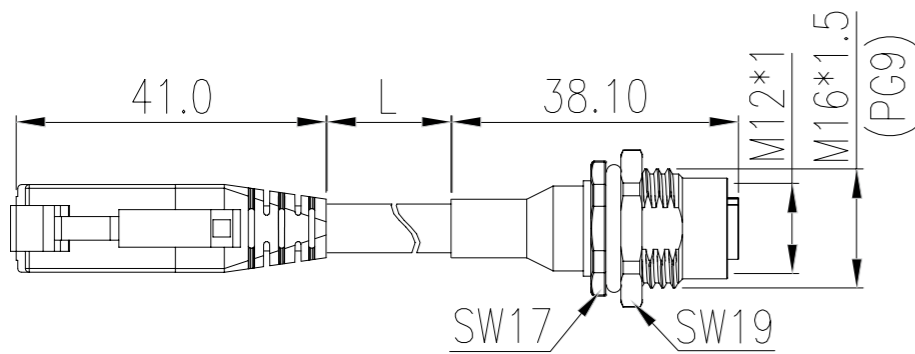









Unit : mm

## M12 D-Code Device Connector Mate RJ45 Connector

	Profinet	Ethernet
Protocols		
Cross-section		
Communication	Profinet (100 Mbps)	Ethernet CAT5 (100 Mbps)
Coding	D	D
Number of cores	4	4
Outer sheath, material	PVC	PUR
Outer sheath, color	Green (RAL 6008)	Blue (RAL 5021)
Outer sheath, diameter	6.5 ± 0.2 mm	6.0 ± 0.3 mm
Ambient temperature (operation)	-40 °C ~ +80 °C	-40 °C ~ +80 °C
Shielding	AL-Foil, tin-plated copper braided shield	AL-mylar, tinned copper braided shield
Conductor material	Stranded tinned copper	Stranded bare copper
AWG signal line	22AWG	26AWG
Wire colors	White, Yellow, Blue, Orange	White/Orange, Orange, White/Green, Green
Core diameter including insulation	1.5 ± 0.1 mm	0.9 ± 0.05 mm
Conductor resistance	59.4 Ω/km(@20 °C)	< 148 Ω/km
Standards / Regulations	IEC 61156-6	ISO/IEC 11801
	UL AWM style	UL 1581
	Flammability test	UL 758
UL AWM style	21694	20963
Flammability test	IEC 60332-1, FT2	IEC 60332-1, FT2

## M12 D-Code Device Connector Mate RJ45 Connector ( Shield ) - Networks

Coding and contacts	Code	D		D	
	Contact	4		4	
Rated voltage / current		250V / 4A		30V / 4A	
Contact arrangement	Male	Female	Male	Female	
					
Cable		PVC		PUR	
Protocols		PROFINET CAT5 (100Mbps)		Ethernet CAT5 (100Mbps)	
<b>Rear mounting mate RJ45 with 2m cable</b>					
	Connector style	Mount thread	Part number		
Male		M16 x 1.5	0206-700-0102	0206-700-0202	
		Pg9	0206-702-0102	0206-702-0202	
Female		M16 x 1.5	0206-710-0102	0206-710-0202	
		Pg9	0206-712-0102	0206-712-0202	

The wire length can be customized. For more details, please contact Dinkle

## M12 X-Code Molded Circular Connector Mate RJ45 Connector

### Straight male mate RJ45 (Shielded)

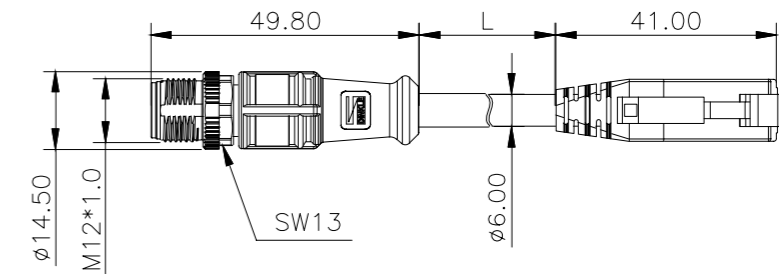

### Straight female mate RJ45 (Shielded)

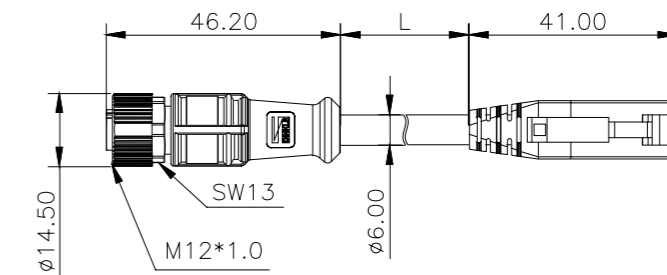

### Angled male mate RJ45 (Shielded)

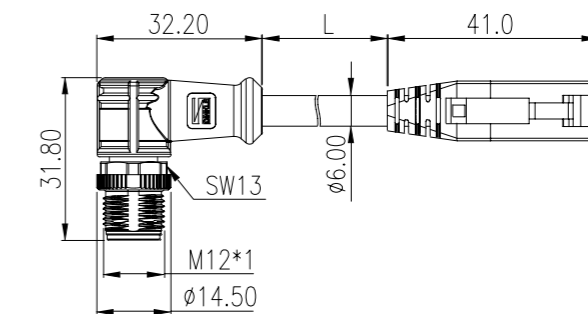

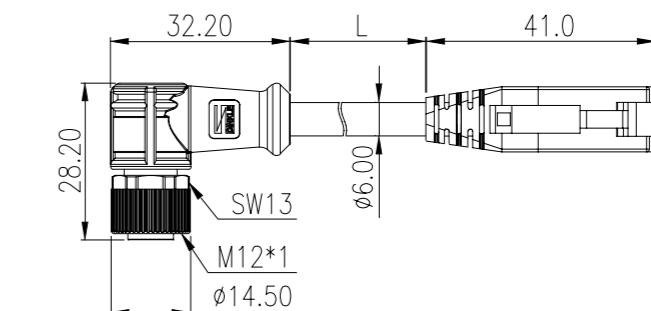

### Angled female mate RJ45 (Shielded)





Unit : mm

## M12 X-Code Molded Connector Mate RJ45 Connector

Protocols	Ethernet
	 <p style="text-align: center;"><b>Ethernet</b></p>
Cross-section	
Communication	Ethernet CAT6A (10 Gbps)
Coding	X
Number of cores	8
Outer sheath, material	PUR
Outer sheath, color	Blue (RAL 5021)
Outer sheath, diameter	6.45 ± 0.2 mm
Ambient temperature (operation)	-40 °C ~ +80 °C
Shielding	AL-mylar, tinned copper braided shield
Conductor material	Stranded bare copper
AWG signal line	26AWG
Wire colors	White/Orange, Orange, White/Green, Green, White/Brown, Brown, White/Blue, Blue
Core diameter including insulation	1.08 ± 0.2 mm
Conductor resistance	148 Ω/km
Standards / Regulations	ISO/IEC 11801
	UL AWM style
	Flammability test
UL AWM style	20549
Flammability test	IEC 60332-1, FT2

## M12 X-Code Molded Connector Mate RJ45 Connector ( Shield ) - Networks



Coding and contacts	Code	<b>X</b>
	Contact	<b>8</b>
Rated voltage / current		50V / 0.5A
Contact arrangement		Male 
Cable		PUR
Protocols		Ethernet CAT6A (10Gbps)
<b>Connector style</b>	<b>Length(m)</b>	<b>Part number</b>
Straight male mate RJ45 	0.6	299-X8AML60
	1.5	299-X8AM015
	3	299-X8AM030

The configuration of connectors and the cable length can be customized. For more details, please contact Dinkle

# Accessories

For sensor/actuator cables, receptacles, and connectors not yet used by field I/O devices, DINKLE offers M8 and M12 plastic sealing caps to increase the IP rating of unmated connectors. Especially for panel and PCB applications, you can also choose a waterproof cover with a rubber strap to avoid the risk of losing the cover during use.



Product	Size	M8		M12	
	Suitable mounting thread	For male	For female	For male	For female
Part number					
	-	-	-	-	200-A002
	-	-	-	200-A001	-
	-	300-A003	-	-	-
	-	-	300-A005	-	-
	M16 x 1.5, Pg9	-	-	200-A003	-
	retaining chain	-	-	-	200-A004
	M12	-	300-A001	-	-
	M8	300-A004	300-A002	-	-

For unused connection endpoints of sensor/actuator cables, sockets, and field I/O devices, Dinkle has introduced the M8 and M12 series plastic sealing caps to enhance the IP rating of unpaired connectors. Specifically, for panel and PCB connectors on the device side, you can also choose waterproof caps with rubber chains to prevent the risk of loss due to dropping during use.