



Delight Through Connections

● **DAUDIN CO., LTD.**

No.19, Wuquan 2nd Road, Wugu District,  
TW24890 New Taipei City, Taiwan  
TEL : +886-2-8069-9000  
FAX : +886-2-2290-1707  
E-mail : service@dinkle.com

● **LI YANG ELECTRIC MACHINERY (DONGGUAN) CO., LTD.**

Ji Ti Gang Industrial Park, Huang Jiang Town, Dong Guan City,  
Guang Dong Province, China 523757  
TEL:+86-769-8336-4350  
FAX:+86-769-8384-8634  
E-mail : service@dinkle.com



www.io-grid.com

Dinkle remains the right of product modification and engineering change of design.  
The catalogue is for reference only. The final product is made according to actual  
engineering drawing.

MAR./2026



**DAUDIN CO., LTD.**

iO-GRID™

# Remote I/O

IC-02.4

# Index

<b>Power Supply Module</b>		<b>USB Converter</b>	
GFPS-0202	P10	GFTL-RM02	P26
GFPS-0303	P10	<b>Interface Module</b>	
<b>Edge Computer</b>		0170-0102	P26
GFPC-0303	P11	0170-0103	P26
<b>Gateway Module</b>		0170-0104	P26
GFGW-RM01N	P12	<b>Power Distribution Module</b>	
GFGW-RM02N	P12	GFPB-0102	P26
<b>Master Module</b>		<b>Standard Bus</b>	
GFMS-RM01N	P13	BS-0X123457RM	P27
GFMS-RM01S	P13	BS-7XX-123457RM	P27
<b>Digital Input Module</b>		<b>Accessories</b>	
GFDI-RM01N	P14	TM42W	P27
<b>Digital Output Module</b>		BS-200	P28
GFDO-RM01N	P15	BS-210	P28
GFDO-RM02N	P15	BS-214	P28
<b>Analog Input Module</b>		BS-C028	P28
GFAI-RM10	P16	BS-WR00101	P28
GFAI-RM11	P16	BS-WR00102	P28
GFAI-RM20	P17	BS-WR00201	P28
GFAI-RM21	P17	BS-WR00202	P28
<b>Analog Output Module</b>		BS-WR00203	P28
GFAO-RM10	P18	BS-WR00204	P28
GFAO-RM11	P18	BS-WR00205	P28
GFAO-RM20	P19	BS-WR00301	P28
GFAO-RM21	P19	BS-WR00302	P28
<b>Analog Input/ Output Module</b>		BS-WR00303	P28
GFAX-RM10	P20	BS-WR00304	P28
GFAX-RM21	P20	BS-WR00305	P28
GFAX-RM20	P21	<b>Tools</b>	
GFAX-RM21	P21	DNT13-0101	P29
<b>RTD Module</b>		DNT04-2010A	P29
GFRT-RM01	P22	<b>Screwdriver</b>	
<b>Counter Module</b>		DNT11-0102	P29
GFDI-RM02N	P23	DNT11-0107	P29
GFHC-RM01	P23	DNT11-0109	P29
<b>Relay Module</b>		DNT11-0111	P29
GFAR-RM11	P24	DNT11-0201	P29
GFAR-RM21	P24	DNT11-0202	P29
<b>USB Converter</b>		DNT11-0205	P29
GFTL-RM01	P26	DNT11-0208	P29

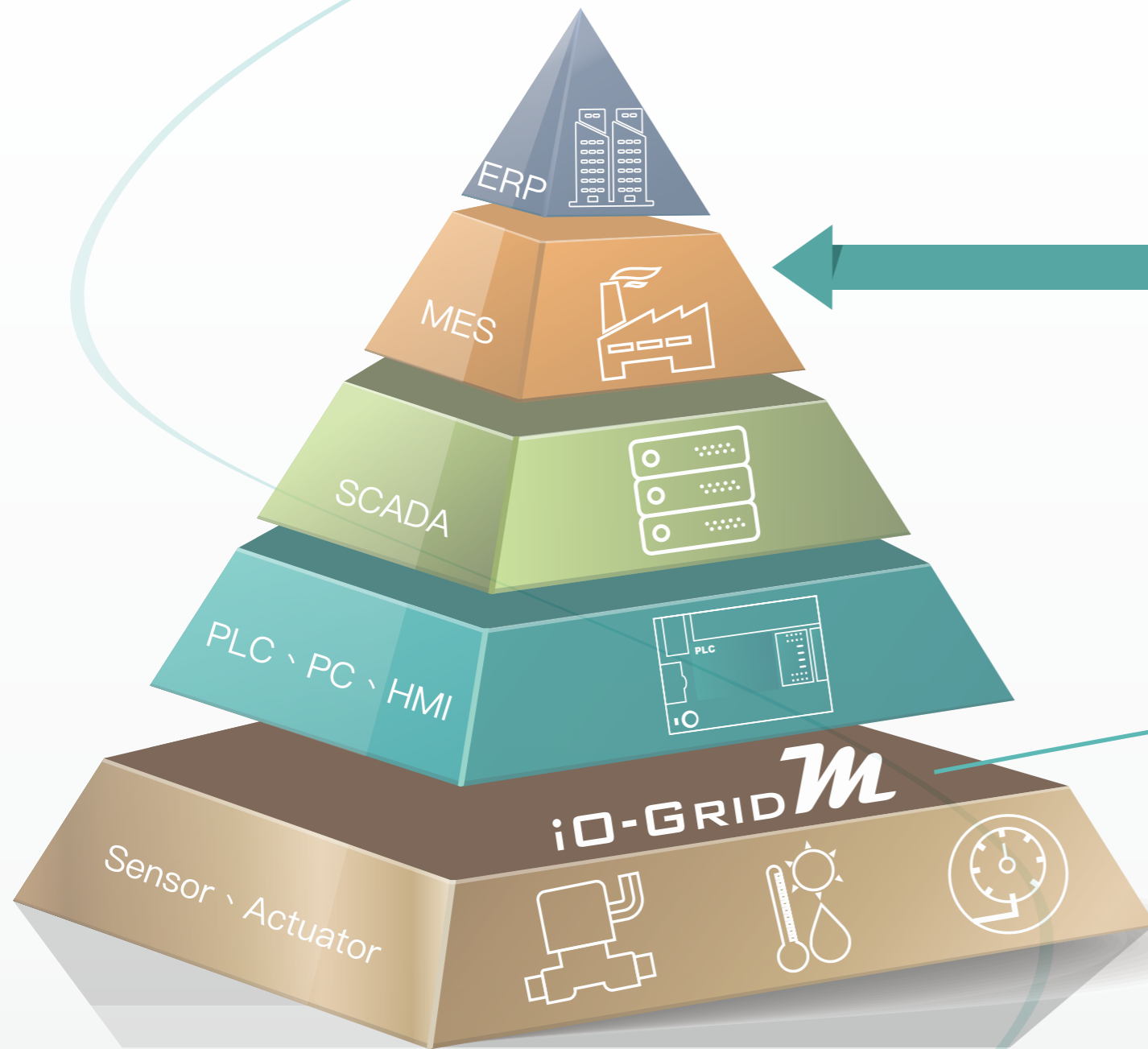

**Data Collection and Analysis for Industrial Production**



**Seamless Connection Between Control and Field Level**



**Application Area**

- General Machinery
- Processing Machinery
- Textile Industry
- Timber Processing
- CNC Machining
- Precision Instrument
- Plastic Machinery
- Tire and Rubber Industry
- Transportation Logistics
- Packaging Machinery
- Printing and Paper Industry
- Handling and Assembly Technology
- Forming Process, Steel Plate Processing
- Wire, Cable and Pipe Industry
- Robotics
- Building Automation
- Wastewater Treatment
- Smart City
- Biotechnology
- Wind Power
- Food Industry
- Solar Energy
- Automobile Industry
- Energy Industry
- Semiconductor Manufacturing
- Medical Engineering
- Smart Agriculture

**and more...**







## First Step Towards Industrialization

- Large volume of data collection for Industry 4.0 can be effortlessly integrated
- Designed for Modbus Protocol, compatible with various types of controllers (i.e., PLC, IPC, etc....)
- Wide selection of function modules to satisfy any industrial field applications
- Fast assembly, simple operation, and improved system efficiency
- EN 61000-6-2 / EN 61000-6-4, IEC / EN / UL 61010-1, IEC / EN / UL 61010-2-201 Standards

## Enhanced Expansion Capability

- Given the different environmental requirements, various function modules can be flexibility configured
- Each master station can connect up to 247 slave stations (approximately 4000 points)
- Modules from only 12 mm wide, provides great aesthetic and organization in panels
- Reduce 70% wiring time and 60% wiring materials
- Easy recognition of module ID and status, improving maintenance efficiency



## Gateway Module

Installed in iO-GRID™ systems for Modbus TCP applications. This module includes Ethernet ports, up to four RS485 ports, and LED indicators. Gateway Module utilizes Modbus TCP protocol to support two-way communication flow of data between iO-GRID™ system and the controller.

## iO-GRID Power Supply

iO-GRID Power Supply converts the standard 100-240 VAC to a stable low voltage 24 VDC. Then from 24 VDC to 5 VDC, the voltage suitable for all the modules in iO-GRID system.

### Power Conversion

- 100-240 VAC to 24 VDC
- 24 VDC to 5 VDC

## RJ45 Interface Module

Utilizes Push-In Design terminal blocks to increase the connectivity efficiency

## Master Module

iO-GRID™ system's Master Module is quick to install and contains simple operation features. The controller only needs to send the commands to the Master Module, and the Master Module can efficiently relay the instructions to the I/O modules.

Master Module contains three sets of RS485 ports, one is used independently, and the other two are connected in tandem.



LED indicator to monitor the operational status of the system.



Mini USB port to setup the system settings.



## Digital Input Module

iO-GRID™ system supports both sinking and sourcing sensors and switches. Every module contains 16 channels, and each channel includes a LED indicator.

## Analog Input Module

Includes voltage and current type modules, satisfying the industrial automation requirements for various meters, analog sensors and other analog signal applications. Every module contains 4 channels, and each channel includes a LED indicator.

## iO-GRID™ Terminal Block

The terminal block utilizes PID (Push-In Design) connectivity, allowing a tool free installation, neat and organized wiring aesthetic, and maximum connection stability.



## iO-GRID™ Simple to Install



## Analog Output Module

Includes voltage and current type modules for various meter. Every module contains 4 channels, and each channel includes a LED indicator and grounding feature.

## Digital Output Module

iO-GRID™ system user can choose between the modules of sinking or sourcing, depending on the circuit requirement.

Every channel includes a LED indicator.

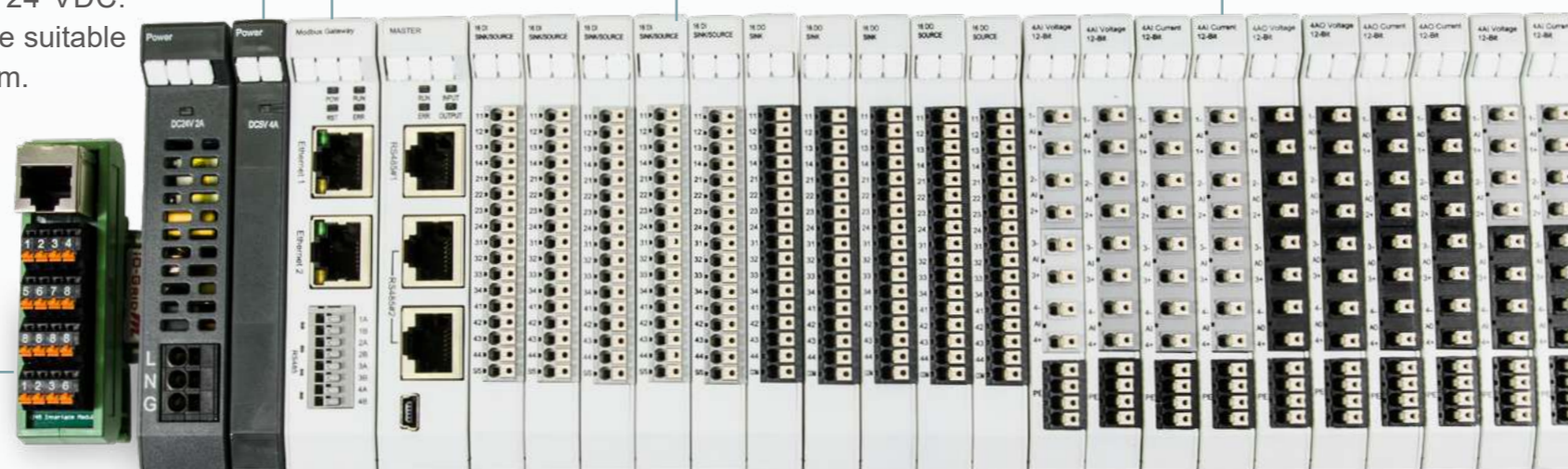
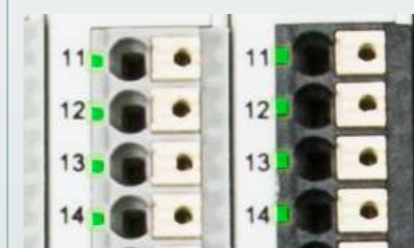





**Power Supply Module**  
For more detail, see Page 10



**Gateway Module**  
For Modbus TCP application.  
For more detail, see Page 12



**Analog I/O Module**  
For more detail, see Page 16-21



**Dinkle Bus Plate**  
For more detail, see Page 27



**Adaptor Module**  
For Relay Module or third-party power supply.  
For more detail, see Page 28



**Master Module**  
For more detail, see Page 13

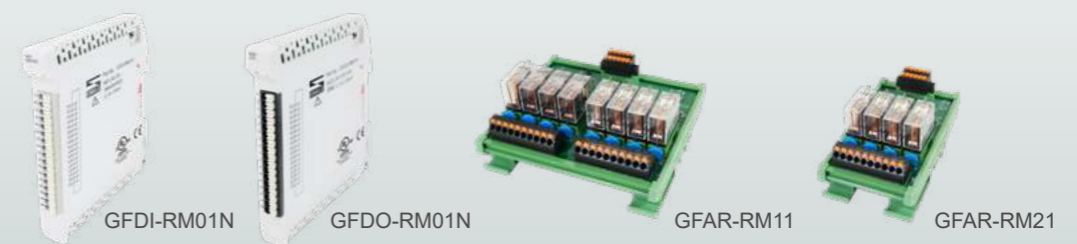

**Digital I/O Module**  
For more detail, see Page 14, 15 and 24

## Power Supply Module



GFPS-0202



GFPS-0303

### Technical Data

<b>Input Nominal Rating</b>	100~240 VAC	<b>Input Nominal Rating</b>	21 ~ 28.8 VDC
<b>Inrush Current (cold start)</b>	34 A	<b>Max Input Current</b>	<1.3 A
<b>Rated Output Power</b>	48 W / 2 A	<b>Rated Output Power</b>	20 W / 4 A
<b>Output Voltage</b>	24 VDC ± 1%	<b>Rated Output Voltage</b>	5 VDC ± 3%
<b>Overload Protection</b>	Hiccup overload protection	<b>Overload Protection</b>	Latching overload protection
<b>Overload</b>	120%-185% Rated output power	<b>Overload</b>	127%-170% Rated output power
<b>Overvoltage Protection</b>	Latching voltage protection	<b>Overvoltage Protection</b>	Clamping protection
<b>Overvoltage</b>	30~34 VDC	<b>Overvoltage</b>	Clamping on 6.5 VDC~6.7 VDC

### General Data

<b>Dimensions W*D*H</b>	20 x 100 x 97 mm	<b>Dimensions W*D*H</b>	12 x 100 x 96 mm
<b>Weight</b>	126 g	<b>Weight</b>	68 g
<b>Operating Temperature</b>	-20...+60°C	<b>Operating Temperature</b>	-20... +70°C
<b>Relative Humidity</b>	RH 20...90%	<b>Relative Humidity</b>	RH 20%...90%
<b>Altitude Limit</b>	< 2000 m	<b>Altitude Limit</b>	< 2000 m
<b>Ingress Protection (IP)</b>	IP 20	<b>Ingress Protection (IP)</b>	IP 20
<b>Pollution Severity</b>	II	<b>Pollution Severity</b>	II
<b>Safety Approval</b>		<b>Safety Approval</b>	
<b>Product Certification</b>	UL 61010-1 & UL 61010-2-201	<b>Product Certification</b>	UL 61010-1 & UL 61010-2-201
<b>Wire Range (IEC/UL)</b>	0.2mm <sup>2</sup> ~ 2.5mm <sup>2</sup> / AWG 26 ~ 12		
<b>Wire Ferrules</b>	DN00708D DN01008D DN01508D		

## Edge Computer



GFPC-0303

### Technical Data

<b>CPU</b>	Broadcom BCM2837B0 Cortex-A53, 64-bit SoC @ 1.2 GHz
<b>Memory</b>	32 GB eMMC Flash memory
<b>Display</b>	HDMI * 1
<b>USB</b>	USB 2.0 *2
<b>Ethernet</b>	100 Mbps Port *2
<b>Indicator</b>	LED for System status * 6
<b>Serial</b>	RS485 / RS232 * 1
<b>Ext. Power Supply</b>	5 VDC
<b>Current Draw</b>	Max. 1A@5 VDC

### General Data

<b>Dimensions W*D*H</b>	40 x 100 x 97 mm
<b>Weight</b>	169 g
<b>Operating Temperature</b>	0...50°C
<b>Storage Temperature</b>	-20...+75°C
<b>Relative Humidity</b>	RH 95%, non-condensing
<b>Safety Approval</b>	
<b>Wiring Range(IEC/UL)</b>	0.2mm <sup>2</sup> ~ 1.5mm <sup>2</sup> / AWG 28 ~ 16
<b>Wiring Ferrules</b>	DN00510D DN00710D

## Gateway Module



GFGW-RM01N



GFGW-RM02N

### Technical Data

Module Type	Modbus TCP Gateway	Modbus TCP Gateway
Power Supply	5 VDC via Dinkle Bus	5 VDC via Dinkle Bus
Current Draw	400 mA @ 5 VDC	400 mA @ 5 VDC
Number Port	Ethernet*2 / RS485*4	Ethernet*2 / RS485*1
Ethernet Interface	RJ45*2	RJ45*2
Serial Interface	PID Terminal Blocks	RS485 via Dinkle Bus
Protocol	Modbus TCP / RTU	Modbus TCP / RTU

### General Data

Dimensions W*D*H	20 x 100 x 97 mm	20 x 100 x 97 mm
Weight	84 g	79 g
Operating Temperature	0...+55°C	0...+55°C
Storage Temperature	-25...+85°C	-25...+85°C
Relative Humidity	RH 95%, non-condensing	RH 95%, non-condensing
Altitude Limit	< 2000 m	< 2000 m
Ingress Protection(IP)	IP 20	IP 20
Pollution Severity	II	II
Safety Approval		
Product Certification	UL 61010-1 & UL 61010-2-201	UL 61010-1 & UL 61010-2-201
Wire Range (IEC/UL)	0.2mm <sup>2</sup> ~ 0.5mm <sup>2</sup> / AWG 28 ~ 20	--
Wire Ferrules	DN00510D	--

## Master Module



GFMS-RM01N



GFMS-RM01S

### Technical Data

Module Type	Master RS485	Master RS485
Power Supply	5 VDC via Dinkle Bus	5 VDC via Dinkle Bus
Max. Expansion Modules	247	247
Current Draw	48 mA @ 5 VDC	48 mA @ 5 VDC
Interface	RS485 via Dinkle Bus	RS485 via Dinkle Bus

### Communication Data

Protocol	Modbus RTU	Modbus RTU
Interface Connector	RJ45	RJ45
Baud Rate Selectable	1200 to 1.5 Mbps	1200 to 1.5 Mbps

### General Data



Dimensions W*D*H	20 x 100 x 97 mm	20 x 100 x 97 mm
Weight	84 g	70 g
Operating Temperature	0...+55°C	0...+55°C
Storage Temperature	-25...+85°C	-25...+85°C
Relative Humidity	RH 95%, non-condensing	RH 95%, non-condensing
Altitude Limit	< 2000 m	< 2000 m
Ingress Protection(IP)	IP 20	IP 20
Pollution Severity	II	II
Safety Approval		
Product Certification	UL 61010-1 & UL 61010-2-201	UL 61010-1 & UL 61010-2-201



## Digital Input Module



GFDI-RM01N

Technical Data	
Number Of Inputs	16
Power Supply	5 VDC via Dinkle Bus
Current Draw	35 mA @ 5 VDC
Voltage Category	24 VDC Sink / Source
On-State Signal Voltage	15...30 VDC
Off-State Signal Voltage	0...10 VDC
Interface	RS485 via Dinkle Bus
Communication Data	
Protocol	Modbus RTU
Format	N, 8, 1
Baud Rate Selectable	1200 to 1.5 Mbps
General Data	
Dimensions W*D*H	12 x 100 x 97 mm
Weight	60 g
Operating Temperature	0...+55°C
Storage Temperature	-25...+85°C
Relative Humidity	RH 95%, non-condensing
Altitude Limit	< 2000 m
Ingress Protection(IP)	IP 20
Pollution Severity	II
Safety Approval	
Product Certification	UL 61010-1 & UL 61010-2-201
Wire Range (IEC/UL)	0.2mm <sup>2</sup> ~ 1.5mm <sup>2</sup> / AWG 28 ~ 16
Wire Ferrules 	DN00510D DN00710D



## Digital Output Module



GFDO-RM01N



GFDO-RM02N

Technical Data		
Number Of Outputs	16	16
Load Voltage	24 VDC (±10%)	24 VDC (±10%)
Power Supply	5 VDC via Dinkle Bus	5 VDC via Dinkle Bus
Current Draw	135 mA @ 5 VDC	135 mA @ 5 VDC
Load Specification	Ohmic, lamp load	Ohmic, lamp load
Sink / Source	Sink	Source
Max. Output Current	0.5 A per channel	0.5 A per channel
Interface	RS485 via Dinkle Bus	RS485 via Dinkle Bus
Communication Data		
Protocol	Modbus RTU	Modbus RTU
Format	N, 8, 1	N, 8, 1
Baud Rate Selectable	1200 to 1.5 Mbps	1200 to 1.5 Mbps
General Data		
Dimensions W*D*H	12 x 100 x 97 mm	12 x 100 x 97 mm
Weight	69 g	69 g
Operating Temperature	0...+55°C	0...+55°C
Storage Temperature	-25...+85°C	-25...+85°C
Relative Humidity	RH 95%, non-condensing	RH 95%, non-condensing
Altitude Limit	< 2000 m	< 2000 m
Ingress Protection (IP)	IP 20	IP 20
Pollution Severity	II	II
Safety Approval		
Product Certification	UL 61010-1 & UL 61010-2-201	UL 61010-1 & UL 61010-2-201
Wire Range (IEC/UL)	0.2mm <sup>2</sup> ~ 1.5mm <sup>2</sup> / AWG 28 ~ 16	0.2mm <sup>2</sup> ~ 1.5mm <sup>2</sup> / AWG 28 ~ 16
Wire Ferrules 	DN00510D DN00710D	DN00510D DN00710D

## Analog Input Module



GFAI-RM10



GFAI-RM11

### Technical Data

	GFAI-RM10	GFAI-RM11
Number Of inputs	4	4
Power Supply	5 VDC via Dinkle Bus	5 VDC via Dinkle Bus
Current Draw	<105 mA @ 5 VDC	<105 mA @ 5 VDC
Resolution	12 bit	12 bit
Input Type	Voltage $\pm 10$ VDC	Voltage 0...10 VDC
Input	Differential	Differential
Accuracy	$\pm 0.1\%$	$\pm 0.1\%$
Input Impedance	400 k $\Omega$ , typical	400 k $\Omega$ , typical
Sample Rate	500 per second	500 per second
Interface	RS485 via Dinkle Bus	RS485 via Dinkle Bus

### Communication Data

	GFAI-RM10	GFAI-RM11
Protocol	Modbus RTU	Modbus RTU
Format	N, 8, 1	N, 8, 1
Baud Rate Selectable	1200 to 1.5 Mbps	1200 to 1.5 Mbps

### General Data

	GFAI-RM10	GFAI-RM11
Dimensions W*D*H	12 x 100 x 97 mm	12 x 100 x 97 mm
Weight	61 g	61 g
Operating Temperature	0...+55°C	0...+55°C
Storage Temperature	-25...+85°C	-25...+85°C
Relative Humidity	RH 95%, non-condensing	RH 95%, non-condensing
Altitude Limit	< 2000 m	< 2000 m
Ingress Protection (IP)	IP 20	IP 20
Pollution Severity	II	II
Safety Approval		
Product Certification	UL 61010-1 & UL 61010-2-201	UL 61010-1 & UL 61010-2-201
Wire Range (IEC/UL)	0.2mm <sup>2</sup> ~ 1.5mm <sup>2</sup> / AWG 28 ~ 16	0.2mm <sup>2</sup> ~ 1.5mm <sup>2</sup> / AWG 28 ~ 16
Wire Ferrules	DN00510D DN00710D	DN00510D DN00710D

## Analog Input Module



GFAI-RM20



GFAI-RM21

### Technical Data

	GFAI-RM20	GFAI-RM21
Number Of Inputs	4	4
Power Supply	5 VDC via Dinkle Bus	5 VDC via Dinkle Bus
Current Draw	<105 mA @ 5 VDC	<105 mA @ 5 VDC
Resolution	12 bit	12 bit
Input Type	Current 0...20 mA	Current 4...20 mA
Input	Differential	Differential
Accuracy	$\pm 0.1\%$	$\pm 0.1\%$
Input Impedance	100 $\Omega$ , typical	100 $\Omega$ , typical
Sample Rate	500 per second	500 per second
Interface	RS485 via Dinkle Bus	RS485 via Dinkle Bus

### Communication Data

	GFAI-RM20	GFAI-RM21
Protocol	Modbus RTU	Modbus RTU
Format	N, 8, 1	N, 8, 1
Baud Rate Selectable	1200 to 1.5 Mbps	1200 to 1.5 Mbps

### General Data

	GFAI-RM20	GFAI-RM21
Dimensions W*D*H	12 x 100 x 97 mm	12 x 100 x 97 mm
Weight	61 g	61 g
Operating Temperature	0...+55°C	0...+55°C
Storage Temperature	-25...+85°C	-25...+85°C
Relative Humidity	RH 95%, non-condensing	RH 95%, non-condensing
Altitude Limit	< 2000 m	< 2000 m
Ingress Protection (IP)	IP 20	IP 20
Pollution Severity	II	II
Safety Approval		
Product Certification	UL 61010-1 & UL 61010-2-201	UL 61010-1 & UL 61010-2-201
Wire Range (IEC/UL)	0.2mm <sup>2</sup> ~ 1.5mm <sup>2</sup> / AWG 28 ~ 16	0.2mm <sup>2</sup> ~ 1.5mm <sup>2</sup> / AWG 28 ~ 16
Wire Ferrules	DN00510D DN00710D	DN00510D DN00710D



## Analog Output Module



GFAO-RM10



GFAO-RM11

Technical Data		
Number Of Outputs	4	4
Power Supply	5 VDC via Dinkle Bus	5 VDC via Dinkle Bus
Current Draw	<235 mA @ 5 VDC	<235 mA @ 5 VDC
Resolution	12 bit	12 bit
Output Type	Voltage $\pm 10$ VDC	Voltage 0...10 VDC
Accuracy	$\pm 0.1\%$	$\pm 0.1\%$
Output Impedance	>2 K $\Omega$	>2 K $\Omega$
Interface	RS485 via Dinkle Bus	RS485 via Dinkle Bus
Communication Data		
Protocol	Modbus RTU	Modbus RTU
Format	N, 8, 1	N, 8, 1
Baud Rate Selectable	1200 to 1.5 Mbps	1200 to 1.5 Mbps
General Data		
Dimensions W*D*H	12 x 100 x 97 mm	12 x 100 x 97 mm
Weight	61 g	61 g
Operating Temperature	0...+55°C	0...+55°C
Storage Temperature	-25...+85°C	-25...+85°C
Relative Humidity	RH 95%, non-condensing	RH 95%, non-condensing
Altitude Limit	< 2000 m	< 2000 m
Ingress Protection (IP)	IP 20	IP 20
Pollution Severity	II	II
Safety Approval		
Product Certification	UL 61010-1 & UL 61010-2-201	UL 61010-1 & UL 61010-2-201
Wire Range (IEC/UL)	0.2mm <sup>2</sup> ~ 1.5mm <sup>2</sup> / AWG 28 ~ 16	0.2mm <sup>2</sup> ~ 1.5mm <sup>2</sup> / AWG 28 ~ 16
Wire Ferrules	DN00510D DN00710D	DN00510D DN00710D

## Analog Output Module



GFAO-RM20



GFAO-RM21

Technical Data		
Number Of Outputs	4	4
Power Supply	5 VDC via Dinkle Bus	5 VDC via Dinkle Bus
Current Draw	<340 mA @ 5 VDC	<340 mA @ 5 VDC
Resolution	12 bit	12 bit
Output Type	Current 0...20 mA	Current 4...20 mA
Accuracy	$\pm 0.1\%$	$\pm 0.1\%$
Output Impedance	<500 $\Omega$	<500 $\Omega$
Interface	RS485 via Dinkle Bus	RS485 via Dinkle Bus
Communication Data		
Protocol	Modbus RTU	Modbus RTU
Format	N, 8, 1	N, 8, 1
Baud Rate Selectable	1200 to 1.5 Mbps	1200 to 1.5 Mbps
General Data		
Dimensions W*D*H	12 x 100 x 97 mm	12 x 100 x 97 mm
Weight	61 g	61 g
Operating Temperature	0...+55°C	0...+55°C
Storage Temperature	-25...+85°C	-25...+85°C
Relative Humidity	RH 95%, non-condensing	RH 95%, non-condensing
Altitude Limit	< 2000 m	< 2000 m
Ingress Protection (IP)	IP 20	IP 20
Pollution Severity	II	II
Safety Approval		
Product Certification	UL 61010-1 & UL 61010-2-201	UL 61010-1 & UL 61010-2-201
Wire Range (IEC/UL)	0.2mm <sup>2</sup> ~ 1.5mm <sup>2</sup> / AWG 28 ~ 16	0.2mm <sup>2</sup> ~ 1.5mm <sup>2</sup> / AWG 28 ~ 16
Wire Ferrules	DN00510D DN00710D	DN00510D DN00710D

## Analog Input/Analog Output Module



GFX-RM10



GFX-RM11

Technical Data		
Number Of Inputs/Outputs	2 inputs / 2 outputs	2 inputs / 2 outputs
Power Supply	5 VDC via Dinkle Bus	5 VDC via Dinkle Bus
Current Draw	<140 mA @ 5 VDC	<140 mA @ 5 VDC
Resolution	12 bit	12 bit
Input / Output Type	Voltage ±10V	Voltage 0...10V
Input	Differential	Differential
Accuracy	±0.1%	±0.1%
Input Impedance	400 kΩ, typical	400 kΩ, typical
Output Impedance	>2 KΩ	>2 KΩ
Sample Rate	500 per second	500 per second
Interface	RS485 via Dinkle Bus	RS485 via Dinkle Bus
Communication Data		
Protocol	Modbus RTU	Modbus RTU
Format	N, 8, 1	N, 8, 1
Baud Rate Selectable	1200 to 1.5 Mbps	1200 to 1.5 Mbps
General Data		
Dimensions W*D*H	12 x 100 x 97 mm	12 x 100 x 97 mm
Weight	61 g	61 g
Operating Temperature	0...+55°C	0...+55°C
Storage Temperature	-25...+85°C	-25...+85°C
Relative Humidity	RH 95%, non-condensing	RH 95%, non-condensing
Altitude Limit	< 2000 m	< 2000 m
Ingress Protection (IP)	IP 20	IP 20
Pollution Severity	II	II
Safety Approval		
Product Certification	UL 61010-1 & UL 61010-2-201	UL 61010-1 & UL 61010-2-201
Wire Range (IEC/UL)	0.2mm <sup>2</sup> ~ 1.5mm <sup>2</sup> / AWG 28 ~ 16	0.2mm <sup>2</sup> ~ 1.5mm <sup>2</sup> / AWG 28 ~ 16
Wire Ferrules	DN00510D DN00710D	DN00510D DN00710D

## Analog Input/Analog Output Module



GFX-RM20



GFX-RM21

Technical Data		
Number Of Inputs/Outputs	2 inputs / 2 outputs	2 inputs / 2 outputs
Power Supply	5 VDC via Dinkle Bus	5 VDC via Dinkle Bus
Current Draw	<240 mA @ 5 VDC	<240 mA @ 5 VDC
Resolution	12 bit	12 bit
Input / Output Type	Current 0...20 mA	Current 4...20 mA
Input	Differential	Differential
Accuracy	±0.1%	±0.1%
Input Impedance	100 Ω, typical	100 Ω, typical
Output Impedance	<500 Ω	<500 Ω
Sample Rate	500 per second	500 per second
Interface	RS485 via Dinkle Bus	RS485 via Dinkle Bus
Communication Data		
Protocol	Modbus RTU	Modbus RTU
Format	N, 8, 1	N, 8, 1
Baud Rate Selectable	1200 to 1.5 Mbps	1200 to 1.5 Mbps
General Data		
Dimensions W*D*H	12 x 100 x 97 mm	12 x 100 x 97 mm
Weight	61 g	61 g
Operating Temperature	0...+55°C	0...+55°C
Storage Temperature	-25...+85°C	-25...+85°C
Relative Humidity	RH 95%, non-condensing	RH 95%, non-condensing
Altitude Limit	< 2000 m	< 2000 m
Ingress Protection (IP)	IP 20	IP 20
Pollution Severity	II	II
Safety Approval		
Product Certification	UL 61010-1 & UL 61010-2-201	UL 61010-1 & UL 61010-2-201
Wire Range (IEC/UL)	0.2mm <sup>2</sup> ~ 1.5mm <sup>2</sup> / AWG 28 ~ 16	0.2mm <sup>2</sup> ~ 1.5mm <sup>2</sup> / AWG 28 ~ 16
Wire Ferrules	DN00510D DN00710D	DN00510D DN00710D



## RTD Module



GFRT-RM01

Technical Data	
Number Of Outputs	4
Power Supply	5 VDC via Dinkle Bus
Current Draw	100 mA@5 VDC
Sensor Connector	2/3/4 wire
Resolution	16 bit
Accuracy	±0.1% FSR
Conversion Time	100ms per channel
Type	Pt50, Pt100, Pt200, Pt500 (-200°C~850°C) Pt1000 (-200°C~300°C) Ni100 (-60°C~180°C) Ni120 (-80°C~260°C)
Diagnostic	Sensor Open or Range Over, then Conversion Data=07FFF(32767)
Interface	RS485 via Dinkle Bus
Communication Data	
Protocol	Modbus RTU
Format	N, 8, 1
Baud Rate Selectable	1200 to 1.5 Mbps
General Data	
Dimensions W*D*H	12 x 100 x 97 mm
Weight	65 g
Operating Temperature	0...+55°C
Storage Temperature	-25...+85°C
Relative Humidity	RH 95%, non-condensing
Altitude Limit	< 2000 m
Ingress Protection (IP)	IP 20
Pollution Severity	II
Safety Approval	
Product Certification	UL 61010-1 & UL 61010-2-201
Wire Range (IEC/UL)	0.2 mm <sup>2</sup> ~ 1.5 mm <sup>2</sup> / AWG 28~16
Wire Ferrules	DN00510D DN00710D

## Counter Module



GFDI-RM02N

Technical Data	
Number Of Inputs	4
Power Supply	5 VDC via Dinkle Bus
Current Draw	37mA@5 VDC
Frequency	Max. 100Hz
On-State Signal Voltage	15...30 VDC
Off-State Signal Voltage	0...10 VDC
Interface	RS485 via Dinkle Bus
Communication	
Protocol	Modbus RTU
Format	N, 8, 1
Baud Rate Selectable	1200 to 1.5 Mbps
General Data	
Dimensions W*D*H	12 x 100 x 97 mm
Weight	60 g
Operating Temperature	0...+55°C
Storage Temperature	-25...+85°C
Relative Humidity	RH 95%, non-condensing
Altitude Limit	< 2000 m
Ingress Protection (IP)	IP 20
Pollution Severity	II
Safety Approval	
Product Certification	UL 61010-1 & UL 61010-2-201
Wire Range (IEC/UL)	0.2 mm <sup>2</sup> ~ 1.5 mm <sup>2</sup> / AWG 28~16
Wire Ferrules	DN00510D DN00710D

# Relay Module

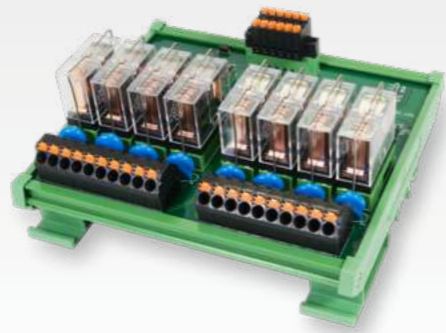

GFAR-RM11



GFAR-RM21

## Technical Data

Number Of Outputs	8	4
Power Supply	24 VDC	24 VDC
Current Draw	<220 mA @ 24 VDC	<109 mA @ 24 VDC
Max. Switching Voltage	250 VAC / 30 VDC	250 VAC / 30 VDC
Max. Switching Current	10 A	10 A
Operation Time	Max 10 ms	Max 10 ms
Release Time	Max 5 ms	Max 5 ms

## Communication Data

Protocol	Modbus RTU	Modbus RTU
Format	N, 8, 1	N, 8, 1
Baud Rate Selectable	1200 to 1.5 Mbps	1200 to 1.5 Mbps

## General Data

Dimensions W*D*H	134 x 121.8 x 60.5 mm	68 x 121.8 x 60.5 mm
Weight	358 g	195 g
Operating Temperature	0...+55°C	0...+55°C
Storage Temperature	-25...+85°C	-25...+85°C
Relative Humidity	RH 95%, non-condensing	RH 95%, non-condensing
Altitude Limit	< 2000 m	< 2000 m
Ingress Protection (IP)	IP 20	IP 20
Pollution Severity	II	II
Safety Approval	CE	CE
Wire Range (IEC/UL)	0.2 mm <sup>2</sup> ~ 1.5 mm <sup>2</sup> / AWG 24 ~ 16	0.2 mm <sup>2</sup> ~ 1.5 mm <sup>2</sup> / AWG 24 ~ 16
Wire Ferrules	DN00508D DN00708D DN01008D	DN00508D DN00708D DN01008D
Wire Range (IEC/UL)	0.2 mm <sup>2</sup> ~2.5 mm <sup>2</sup> / AWG 24~12	0.2 mm <sup>2</sup> ~2.5 mm <sup>2</sup> / AWG 24~12
Wire Ferrules	DN00508D DN00708D DN01008D DN01510D	DN00508D DN00708D DN01008D DN01510D

iO-GRID™

# ACCESSORIES

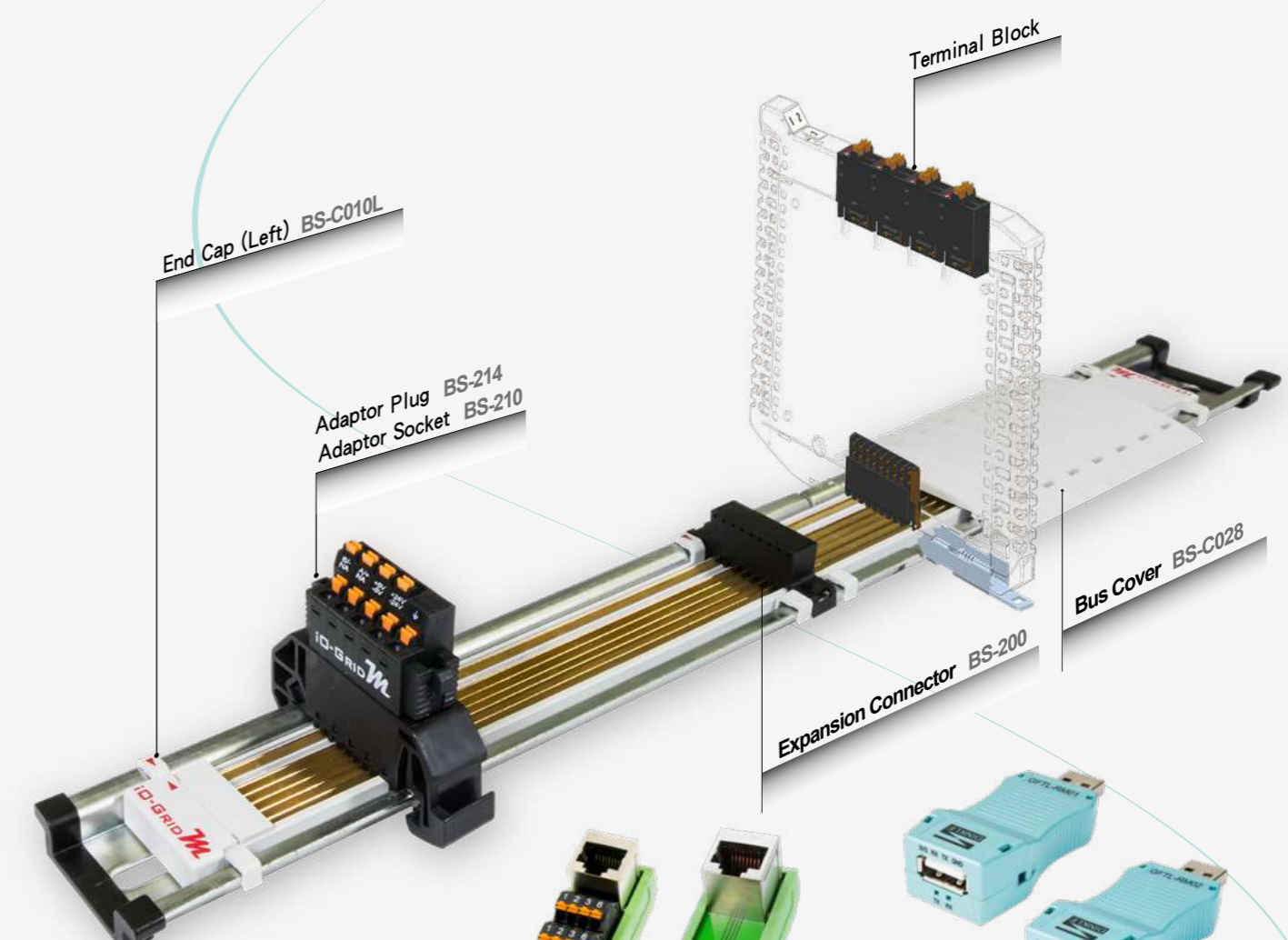
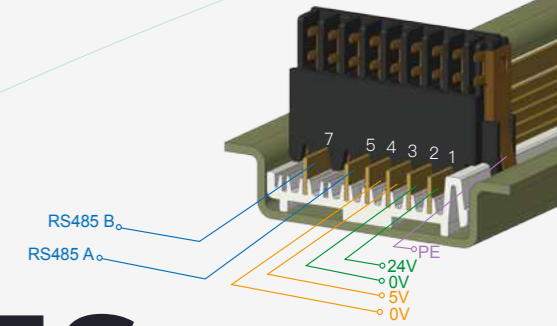

Wire Harness 6+6



Wire Harness 3+3



Wire Harness 5+5

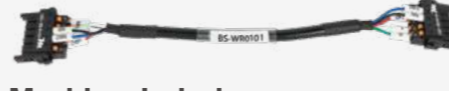

Marking Label



Interface Module



USB Converter

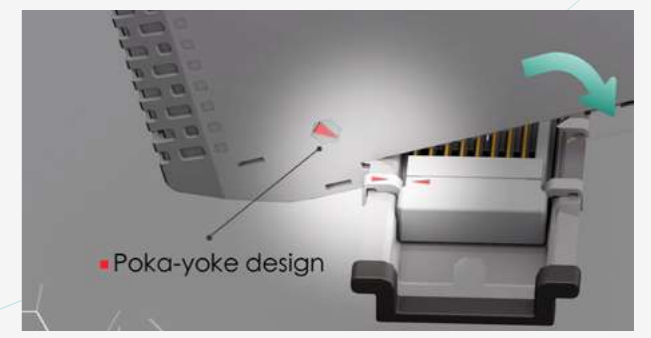

Poka-yoke design



## USB Converter

### GFTL-RM01

iD-GRID™ Setup  
USB / RS232



### GFTL-RM02

RS485 communication  
USB / RS485



Wire range (IEC/UL)	0.2 ~ 1.5mm <sup>2</sup> / AWG 28 ~ 16
Wire ferrules	DN00510D DN00710D

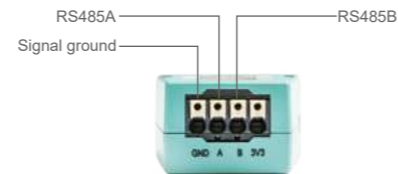

## Interface Module

### 0170-0102

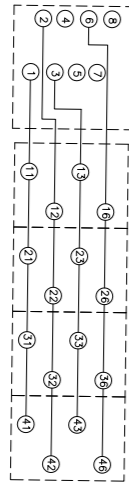

Terminal block  
Ethernet RJ45 female connector  
Wire range (IEC/UL): 0.14 ~ 1.5mm<sup>2</sup> / AWG 28 ~ 16

### 0170-0103

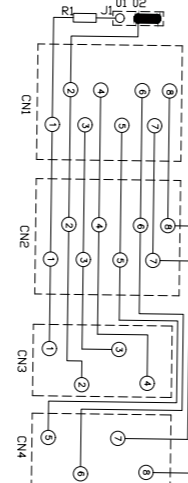

Terminal block  
Ethernet RJ45 female connector  
Wire range (IEC/UL): 0.14 ~ 1.5mm<sup>2</sup> / AWG 28 ~ 16

## Interface Module

## Power Distribution Module

### 0170-0104

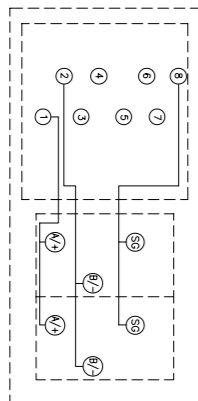

Terminal block  
8 pin RJ45 female connector  
RS485 Interface  
Wire range (IEC/UL): 0.14 ~ 1.5mm<sup>2</sup> / AWG 28 ~ 16

### GFPB-0102

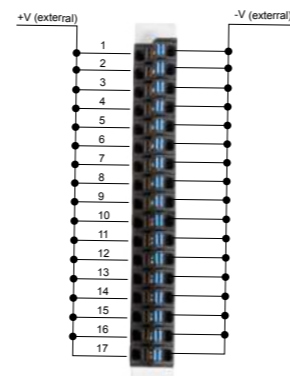

24VDC power distribution  
External power supply  
Wire range (IEC/UL): 0.2 ~ 1.5mm<sup>2</sup> / AWG 28 ~ 16

## Standard Bus



BS-0X123457RM

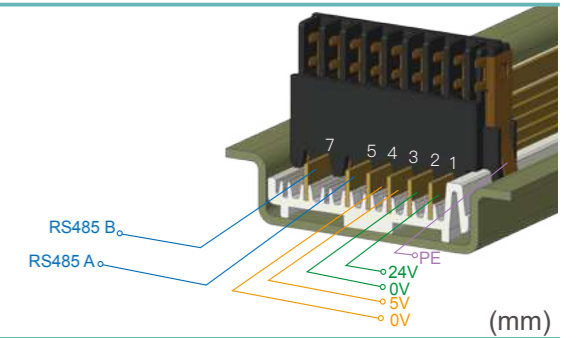
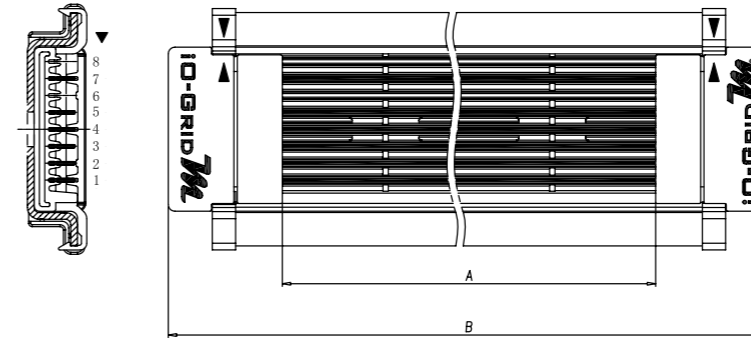

Part No.	A	B
BS-07123457RM	61	95.2
BS-00123457RM	91	125.2
BS-01123457RM	121	155.2
BS-02123457RM	171	205.2
BS-03123457RM	221	255.2
BS-04123457RM	271	305.2
BS-05123457RM	331	365.2



BS-7XX-123457RM

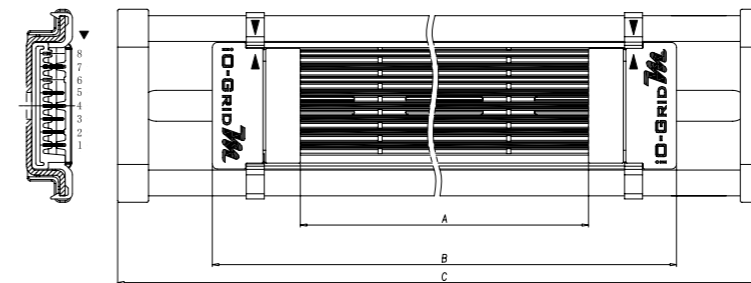

Part No.	A	B	C
BS-740-123457RM	61	95.2	200
BS-700-123457RM	91	125.2	200
BS-701-123457RM	121	155.2	200
BS-702-123457RM	171	205.2	300
BS-703-123457RM	221	255.2	300
BS-704-123457RM	271	305.2	400
BS-705-123457RM	331	365.2	400

## Marking label



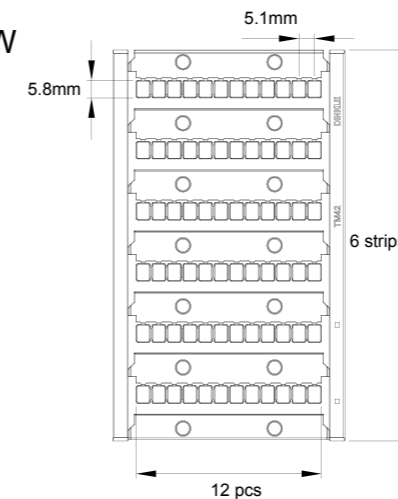

### TM42W



If there are any marker requirements, please refer to Dinkle's official website for more information of D-Thermo, the thermal transfer printer.



## Bus Accessories

Expansion Connector BS-200		Adaptor Socket BS-210		Adaptor Plug BS-214		Bus cover BS-C028	
							
Number of channels	8	Number of channels	9	Number of channels	9	Applied temperature	-40°C~+105°C
pitch(mm)	2.54	Rated voltage	150V	Rated voltage	150V		
Rated voltage	12V~150V	Rated current	8A	Rated current	8A		
Rated current	Max.8A	Rated withstand voltage	1600V	Rated withstand voltage	1600V		
Rated withstand voltage	1600V	Applied temperature	-40°C~+105°C	Applied temperature	-40°C~+105°C		
Applied temperature	-40°C~+105°C			Wire range (IEC/UL)	0.2~1.5mm <sup>2</sup> / AWG 28~16		

			
------------------------------------------------------------------------------------	------------------------------------------------------------------------------------	-------------------------------------------------------------------------------------	--------------------------------------------------------------------------------------

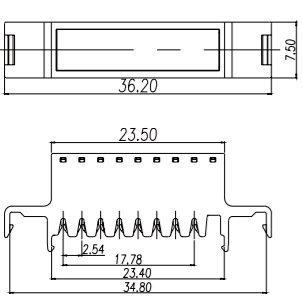
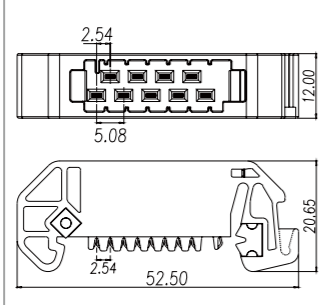
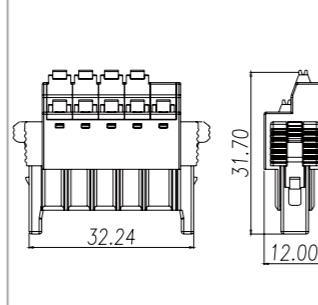
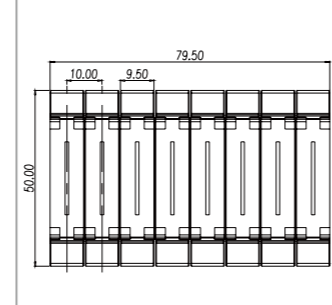
### Wire Harness 6+6



Diagram showing terminal connections for Wire Harness 6+6 (Part No. BS-WR0101):

- (24P) 1 ○ ——— ○ 1 (24P)
- (24N) 2 ○ ——— ○ 2 (24N)
- (5P) 3 ○ ——— ○ 3 (5P)
- (5N) 4 ○ ——— ○ 4 (5N)
- (1A) 5 ○ ——— ○ 5 (1A)
- (1B) 7 ○ ——— ○ 7 (1B)

Part No.	A
BS-WR00101	0.25 m
BS-WR00102	0.4 m

### Wire Harness 3+3



Diagram showing terminal connections for Wire Harness 3+3 (Part No. BS-WR00201):

- (5N) 4 ○ ——— ○ 4 (5N)
- (1A) 5 ○ ——— ○ 5 (1A)
- (1B) 7 ○ ——— ○ 7 (1B)

Part No.	A
BS-WR00201	0.25 m
BS-WR00202	0.50 m
BS-WR00203	1 m
BS-WR00204	1.5 m
BS-WR00205	2 m

### Wire Harness 5+5

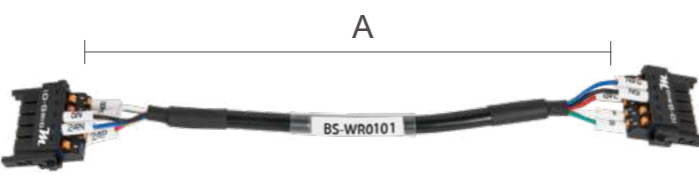
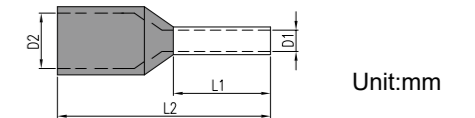

Diagram showing terminal connections for Wire Harness 5+5 (Part No. BS-WR0101):

- (24P) 1 ○ ——— ○ 1 (24P)
- (24N) 2 ○ ——— ○ 2 (24N)
- (5N) 4 ○ ——— ○ 4 (5N)
- (1A) 5 ○ ——— ○ 5 (1A)
- (1B) 7 ○ ——— ○ 7 (1B)

Part No.	A
BS-WR00301	0.25 m
BS-WR00302	0.5 m
BS-WR00303	1 m
BS-WR00304	1.5 m
BS-WR00305	2m

## Wire Ferrules



Part No.	Wire Range		Dimension				Package (pcs)		DIN Color	Tools
	AWG	mm <sup>2</sup>	D1	D2	L1	L2	bag	box		
DN00206D	24	0.2	0.75	1.9	6	10	1,000	10,000	● Light Blue	<b>Note:</b> The wire diameter of the table is determined according to UL486E, IEC998-1 and IEC947-7. Please refer to the table to select suitable ferrules. All recommended ferrules in this catalogue are in accordance with this table.
DN00208D					8	12	1,000	10,000		
DN00306D	22	0.34	0.8	1.9	6	10	1,000	10,000	● Turquoise	
DN00308D					8	12	1,000	10,000		
DN00506D	20	0.5	1	2.6	6	12	500	5,000	○ White	
DN00508D					8	14	500	5,000		
DN00510D					10	16	500	4,000		
DN00706D	18	0.75	1.2	2.8	6	12	500	4,000	● Grey	
DN00708D					8	14	500	4,000		
DN00710D					10	16	500	4,000		
DN00712D					12	18	500	4,000		
DN01006D		1	1.4	3	6	12	500	3,000	● Red	
DN01008D					8	14	500	3,000		
DN01010D					10	16	500	3,000		
DN01012D					12	18	500	3,000		
DN01508D	16	1.5	1.7	3.5	8	14	500	2,000	● Black	
DN01510D					10	16	500	2,000		
DN01512D					12	18	500	2,000		
DN01518D					18	24	500	2,000		

**DNT13-0101**  
 28-7 AWG  
 0.08-10 mm<sup>2</sup>

**DNT04-2010A**  
 20~10 AWG  
 0.6-5 mm<sup>2</sup>

## Slotted Screwdriver

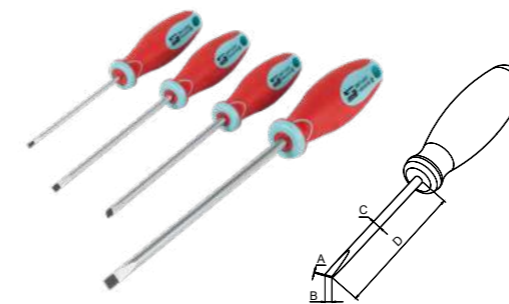

## Phillips Screwdriver



Technica Data	Slotted screwdriver				Phillips screwdriver			
	DNT11-0102	DNT11-0107	DNT11-0109	DNT11-0111	DNT11-0201	DNT11-0202	DNT11-0205	DNT11-0208
Part number								
Size	2.5 X 75 mm	3.5 X 100 mm	4.0 X 100 mm	5.5 X 150 mm	#0 X 60	#1 X 80	#2 X 100	#3 X 150
A	2.5	3.5	4.0	5.0	-	-	-	-
B	0.4	0.6	0.8	1.0	-	-	-	-
C	2.5	3.5	4.0	5.0	3.0	5.0	6.0	8.0
D	75	100	100	150	60	80	100	150
E	21.6	21.6	21.6	27.2	21.6	27.7	33	37.5
F	70	70	70	90	70	90	108	122
Package	12	12	12	12	12	12	12	6









